



California Stormwater Quality Association

**Stormwater Best Management Practice**

# Handbook

## **New Development and Redevelopment**

New Development  
and Redevelopment



Construction



Industrial  
and Commercial



Municipal

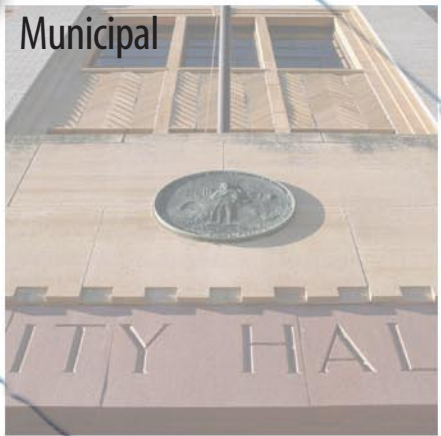



# Copyright Statement

Copyright 2003 by the California Stormwater Quality Association, all rights reserved. Unless in conformance with the Permission to Use statement below, no part of this document may be reproduced or distributed in any form or by any means, or stored in a database or retrieval system, without the prior written permission of the California Stormwater Quality Association. Requests for permission shall be directed to CASQA at: [info@casqa.org](mailto:info@casqa.org).

## *Permission to Use*

Permission granted to user\* by the California Stormwater Quality Association for:

1. Individual, personal single copy reproduction for an individual use only, not for resale;
2. Public agency, in-house multi-copy reproduction for distribution and use within a single public agency or MS4 areawide program only – not for resale; or
3. Public / business and trade association in-house multi-copy reproduction for distribution and use within a single public / business and trade association only – not for resale (excluding distribution to members).

Prior written approval of the California Stormwater Quality Association is required by user for any other use.

## *Restrictions Applicable to Commercial Reproduction*

Commercial reproduction of individual or multiple copies, or portions thereof, is strictly prohibited without the prior written approval of CASQA. Requests for permission shall be directed to CASQA at: [info@casqa.org](mailto:info@casqa.org).

\* User – Individual or organization that receives a CASQA product directly from CASQA. Individuals or organizations that receive a CASQA product other than directly from CASQA are not considered users as the term is used in this Copyright Statement.



# Acknowledgements

The Stormwater Best Management Practice Handbooks are products of the California Stormwater Quality Association (CASQA). The handbooks were originally published in 1993 by the California Stormwater Quality Task Force (SWQTF), the predecessor of CASQA. As part of this project, the original handbooks have been updated to reflect the current state of stormwater quality management practices and to make the handbook accessible via the Internet at [www.cabmphandbooks.com](http://www.cabmphandbooks.com).

CASQA is a nonprofit public benefit corporation and is not organized for private gain of any person. It is organized under the Nonprofit Public Benefit Corporation Law of California for charitable and educational purposes. The specific purpose of CASQA is to assist those entities charged with stormwater quality management responsibilities with the development and implementation of stormwater quality goals and programs. CASQA serves its members through various educational, technical, and scientific initiatives. The publication of the Stormwater Best Management Practice Handbooks is one of CASQA's educational and technical initiatives.

This project was funded through contributions from public agencies throughout California, whose support made the handbooks possible. Contributing agencies include:

## State Agencies

California Department of  
Transportation

California State Water Resources  
Control Board

## County Agencies

Alameda County

Contra Costa County

Los Angeles County

Marin County

Orange County

Sacramento County

Santa Barbara County

Santa Clara County

San Diego County

San Mateo County

Siskiyou County

## Municipalities

City of Bakersfield

City of Carmel

City of Fairfield

City of Lodi

City of Long Beach

City of Modesto

City of Monterey

City of Sacramento

City of San Diego

City of Santa Rosa

City of Stockton

City of Visalia

City of Watsonville

City of Woodland

## **Special Districts**

Fresno Metropolitan Flood Control District

Port of San Diego

Riverside County Flood Control and Water Conservation District

San Bernardino County Flood Control District

Vallejo Sanitation and Flood Control District

Ventura County Flood Control District

The development of the Stormwater Best Management Practice Handbooks was guided by a Steering Committee, a Technical Advisory Committee, and the CASQA BMP Workgroup. The Steering Committee provided CASQA's direction to the Consultant. The Steering Committee included representatives from Phase I communities, special districts, regulatory agencies, and consulting. The Technical Advisory Committee and BMP Workgroup reviewed draft work products and provided comments to the Steering Committee. The Technical Advisory Committee included representatives from Phase I communities, Phase II communities, regulatory agencies (water quality and health), academia, industry, transportation, and consulting. The quality of the handbooks is a result of the diverse expertise and experience of the committees and the workgroup.

## **Steering Committee**

Scott Taylor, Committee Chair, RBF Consulting

Bruce Fujimoto, California State Water Resources Control Board

Naresh Varma, San Bernardino County Flood Control District

Karen Ashby, Orange County Public Facilities and Resources Department

Steve Stump, Riverside County Flood Control and Water Conservation District

Bill Busath, City of Sacramento

Mark Wills, Riverside County Flood Control and Water Conservation District

Melinda Marks, Fresno Metropolitan Flood Control District

## **Technical Advisory Committee**

Scott Taylor, Committee Chair, RBF Consulting

John Johnston, California State University Sacramento Faculty Member

Karen Henry, City of San Diego

Jennifer Gonzalez, City of Monterey

Xavier Swamikannu, Los Angeles Regional Water Quality Control Board

Tim Piasky, Building Industry Association and Associated General Contractors

Marco Metzger, California Department of Health Services

Dan Barber, Concrete Industries

Jerry Marcotte, California Department of Transportation

U.S. Environmental Protection Agency

The County of San Bernardino and San Bernardino County Flood Control District, under the direction of Naresh Varma, Chief, Environmental Management Division, provided financial and contract management services on behalf of the California Stormwater Quality Task Force and the California Stormwater Quality Association for the update and revision of the Stormwater Best Management Practice Handbooks.

The Stormwater Best Management Practice Handbooks were prepared by the Camp Dresser & McKee Inc. (CDM) and Larry Walker Associates (LWA) team. The CDM-LWA team was led by Jeff Endicott, CDM Officer-in-Charge and Project Manager, and Mack Walker, LWA Project Manager. The handbook team included the following consultants and individuals:

## **Consultant Team**

### **Camp Dresser & McKee Inc.**

Jeff Endicott, P.E., Officer-in-Charge and Handbook Project Manager

Janelle Rogers, Ph.D., P.E. (WA) Assistant Project Manger

Don Schroeder, P.E.

Luis Leon, P.E.

Stephen Liao, P.E.

Brendan Boyd

Tracy Gaudino

Basheera Raheem-Streetz

### **Larry Walker Associates**

Mack Walker, P.E., Handbook Project Manager

Heather Kirschmann

## *Acknowledgements*

Erich Simon

Dean Messer, Ph.D.

### **Catalyst**

Tom Richman, ASLA, AICP

**Mike Barrett, Ph.D., P.E. (TX)**

**Geoff Brosseau**

**Gary Minton, Ph.D., P.E. (WA)**

### **Disclaimer**

The California Stormwater Quality Handbooks are intended to provide a range of general information about stormwater quality best management practices (BMPs) and related issues. Due to the multitude of applications of BMPs, the Handbooks do not address site-specific applications. Therefore, users of the Handbooks must seek advice of a stormwater quality professional to determine the applicability of the information provided for any general use or site-specific application. Users of the Handbooks assume all liability directly or indirectly arising from use of the Handbooks.

The mention of commercial products, their source, or their use in connection with material reported in the Handbooks is not to be construed as either an actual or implied endorsement, recommendation, or warranty of such product.

This disclaimer is applicable whether information from the Handbooks is obtained in hard copy form or downloaded from the Internet.



# Contents

<b>Section 1</b>	<b>Introduction .....</b>	<b>1-1</b>
1.1	Handbook Purpose and Scope .....	1-1
1.1.1	Users of the Handbook .....	1-1
1.1.2	Organization of the Handbook .....	1-2
1.1.3	Relationship to Other Handbooks .....	1-3
1.2	Stormwater Pollutants and Impacts on Water Quality .....	1-4
1.3	Regulatory Requirements .....	1-6
1.3.1	Federal Programs .....	1-6
1.3.2	State Programs .....	1-7
1.3.3	Municipal NPDES Stormwater Programs .....	1-7
1.3.4	Other Relevant Regulatory Programs .....	1-7
1.4	Definitions .....	1-10
1.5	References and Resources .....	1-10
<b>Section 2</b>	<b>Stormwater Quality Planning for New Development and Redevelopment .....</b>	<b>2-1</b>
2.1	Introduction .....	2-1
2.2	Permit Requirements .....	2-1
2.3	Developing a Stormwater Management Plan .....	2-3
2.3.1	Assess Site Conditions .....	2-3
2.3.2	Understand Hydrologic Conditions of Concern .....	2-4
2.3.3	Evaluate Pollutants of Concern .....	2-5
2.3.4	Identify Candidate BMPs .....	2-6
2.3.5	Determine BMP Size/Capacity .....	2-6
2.3.6	Develop Plan for BMP Maintenance .....	2-8
2.4	Planning Principles .....	2-9
2.4.1	Reduce Runoff .....	2-9
2.4.2	Control Sources of Pollutants .....	2-18
2.4.3	Treat Runoff .....	2-18
2.4.4	Planning Development Strategies in Practice .....	2-19
<b>Section 3</b>	<b>Site and Facility Design for Water Quality Protection.....</b>	<b>3-1</b>
3.1	Introduction .....	3-1
3.2	Integration of BMPs into Common Site Features .....	3-1
3.2.1	Streets .....	3-4
3.2.2	Parking Lots .....	3-6
3.2.3	Driveways .....	3-9
3.2.4	Landscape and Open Space .....	3-11
3.2.5	Outdoor Work Areas .....	3-13
3.2.6	Maintenance and Storage Areas .....	3-15
3.2.7	Vehicle and Equipment Washing Areas .....	3-15

3.2.8	Loading Area .....	3-15
3.2.9	Trash Storage Area .....	3-16
3.2.10	Wash Areas .....	3-16
3.2.11	Fueling Areas .....	3-16
<b>Section 4</b>	<b>Source Control BMPs .....</b>	<b>4-1</b>
4.1	Introduction .....	4-1
4.2	BMP Fact Sheets .....	4-1
4.3	Fact Sheet Format.....	4-1
4.4	BMP Fact Sheet .....	4-1
<b>Section 5</b>	<b>Treatment Control BMPs .....</b>	<b>5-1</b>
5.1	Introduction .....	5-1
5.2	Treatment Control BMPs .....	5-1
5.3	Fact Sheet Format.....	5-2
5.4	Comparing Performance of Treatment BMPs.....	5-2
5.4.1	Variation in Performance .....	5-2
5.4.2	Other Issues Related to Performance Comparisons .....	5-6
5.4.3	Comparisons of Treatment BMPs for Nitrogen, Zinc, Bacteria, and TSS .....	5-7
5.4.4	General Performance of Manufactured BMPs .....	5-10
5.4.5	Technology Certification .....	5-12
5.5	BMP Design Criteria for Flow and Volume.....	5-12
5.5.1	Volume-Based BMP Design.....	5-15
5.5.2	Flow-Based BMP Design.....	5-18
5.5.3	Combined Volume-Based and Flow-Based BMP Design .....	5-21
5.6	Other BMP Selection Factors .....	5-22
5.6.1	Costs .....	5-22
5.6.2	Vector Breeding Considerations .....	5-23
5.6.3	Threatened and Endangered Species Considerations .....	5-23
5.7	BMP Fact Sheets .....	5-23
<b>Section 6</b>	<b>Long-Term Maintenance of BMPs .....</b>	<b>6-1</b>
6.1	Introduction .....	6-1
6.2	Critical Regulatory Components .....	6-1
6.3	Enforcement Options .....	6-2
6.4	Maintenance Agreements .....	6-2
6.5	Public Funding Sources .....	6-3
<b>Section 7</b>	<b>Glossary and List of Acronyms .....</b>	<b>7-1</b>
7.1	Glossary .....	7-1
7.2	Acronyms .....	7-5

**List of Tables**

Table 1-1	Pollutant Impacts on Water Quality .....	1-5
Table 2-1	Anticipated and Potential Pollutants Generated by Land Use Type	2-7
Table 2-2	Estimated C-Factors for Various Surfaces During Small Storms..	2-15
Table 2-3	Conventional Paving Surface Small Storm C-Factors vs. Alternative Paving C-Factors .....	2-15
Table 2-4	Site Design and Landscaping Techniques.....	2-17
Table 2-5	Comparison of Three Alternatives.....	2-23
Table 3-1	Adopted Narrow Street Standards (Typ. Cross-Sections, two-way traffic) .....	3-5
Table 4-1	Source Control BMPs for Design.....	4-1
Table 5-1	Treatment Control BMPs .....	5-1
Table 5-2	Incremental Design Criteria vs. Storms Treated at San Jose, CA	5-14
Table 5-3	Use of Rational Formula for Stormwater BMP Design.....	5-20
Table 5-4	Economic Comparison Matrix-Flow .....	5-22
Table 5-5	Economic Comparison Matrix-Volume .....	5-22

**List of Figures**

Figure 2-1	Project Lifecycle .....	2-1
Figure 2-2	NPDES Stormwater Permit Requirements .....	2-1
Figure 2-3	Typical Treatment BMP Thresholds .....	2-2
Figure 2-4	Hydraulic Alteration after Certain BMPs are Implemented .....	2-4
Figure 2-5	Planning Principles.....	2-9
Figure 2-6	Directly Connected Impervious Area .....	2-11
Figure 2-7	Zero Discharge Area Usage .....	2-14
Figure 2-8	Self-Treating Area Usage .....	2-15
Figure 2-9	Impervious Parking Lot vs. Parking Lot with Some Pervious Surfaces .....	2-16
Figure 2-10	Alternative 1: Conventional.....	2-20
Figure 2-11	Alternative 2: Hybrid/Best Practices .....	2-21
Figure 2-12	Alternative 3: Neo-Traditional.....	2-22
Figure 3-1	Infiltration Basin.....	3-1
Figure 3-2	Simple Detention System.....	3-2
Figure 3-3	Retention System .....	3-3
Figure 3-4	Vegetated Swale.....	3-3
Figure 3-5	Comparison of Street Cross-Selection (two-way traffic, residential access streets) .....	3-6
Figure 3-6	Hybrid Parking Lot .....	3-7
Figure 3-7	Turf Blocks .....	3-7
Figure 3-8	Permeable Joints .....	3-7
Figure 3-9	Parking Grove .....	3-8
Figure 3-10	Parking Grove .....	3-8

Figure 3-11	Overflows Parking .....	3-8
Figure 3-12	Porous Pavement Recharge Bed .....	3-9
Figure 3-13	Traditional Design Drains Flow Directly to Storm Drain .....	3-10
Figure 3-14	Alternative Solution Slopes Flow to Groundcover .....	3-10
Figure 3-15	Unit Pavers .....	3-10
Figure 3-16	Crushed Aggregate .....	3-10
Figure 3-17	Paving Only Under Wheels .....	3-10
Figure 3-18	Material Storage .....	3-15
Figure 4-1	Example Fact Sheet .....	4-1
Figure 5-1	Example Fact Sheet .....	5-2
Figure 5-2	Removal Efficiency versus Influent Concentration .....	5-3
Figure 5-3	Box-Whisker Plot .....	5-4
Figure 5-4	Observed Effluent Concentrations for Several Different Public Domain BMPs .....	5-5
Figure 5-5	Total Nitrogen in Effluent .....	5-8
Figure 5-6	Total Dissolved Zinc in Effluent .....	5-8
Figure 5-7	Total Zinc in Effluent .....	5-9
Figure 5-8	Total Fecal Coliforms in Effluent .....	5-9
Figure 5-9	Total Suspended Solids in Effluent .....	5-11
Figure 5-10	Total Suspended Solids in Effluent (log-format) .....	5-11
Figure 5-11	Rain Storms at San Jose, CA .....	5-13
Figure 5-12	Rain Intensity at San Jose, CA .....	5-13
Figure 5-13	Rain Storms at San Jose, CA 1948-2000 .....	5-14
Figure 5-14	Capture/Treatment Analysis at San Jose, CA .....	5-16

## Appendices

*Appendix A* Channel Impacts from Watershed Changes

*Appendix B* General Applicability of Effluent Probability

*Appendix C* Comparison of Effluent Concentrations of Additional Metals

*Appendix D* Rain Gauge Data

# Section 1

## Introduction

Stormwater runoff is part of a natural hydrologic process. However, human activities particularly urbanization and agriculture, can alter natural drainage patterns and add pollutants to rivers, lakes, and streams as well as coastal bays and estuaries, and ultimately, the ocean. Numerous studies have shown urban runoff to be a significant source of water pollution, causing declines in fisheries, restrictions on swimming, and limiting our ability to enjoy many of the other benefits that water resources provide. Urban runoff in this context includes all flows discharged from urban land uses into stormwater conveyance systems and receiving waters and includes both dry weather non-stormwater sources (e.g., runoff from landscape irrigation, etc.) and wet weather stormwater runoff. In this handbook, urban runoff and stormwater runoff are used interchangeably.

For many years the effort to control the discharge of stormwater focused on quantity (e.g. drainage, flood control) and only to a limited extent on quality of the stormwater (e.g. sediment and erosion control). However, in recent years awareness of the need to improve water quality has increased. With this awareness federal, state and, local programs have been established to pursue the ultimate goal of reducing pollutants contained in stormwater discharges to our waterways. The emphasis of these programs is to promote the concept and the practice of preventing pollution at the source, before it can cause environmental problems (USEPA, 1992). However, where further controls are needed, treatment of polluted runoff may be required.

### 1.1 Handbook Purpose and Scope

The purpose of this handbook is to provide general guidance for selecting and implementing Best Management Practices (BMPs) to reduce pollutants in runoff in newly developed areas and redeveloped areas to waters of the state. This handbook also provides guidance on developing project-specific stormwater management plans including selection and implementation of BMPs for a particular development or redevelopment project.

This handbook provides the framework for an informed selection of BMPs. However, due to the diversity in climate, receiving waters, construction site conditions, and local requirements across California, this handbook does not dictate the use of specific BMPs and therefore cannot guarantee compliance with NPDES permit requirements or local requirements specific to the user's site.

#### 1.1.1 Users of the Handbook

This handbook provides guidance suitable for use by individuals involved in development or redevelopment site water pollution control and planning. Each user of the handbook is responsible for working within their capabilities obtained through training and experience, and for seeking the advice and consultation of appropriate experts at all times.

The target audience for this handbook includes: Developers, including their planners and engineers; contractors and subcontractors, including their engineers, superintendents, foremen, and construction staff; municipal agencies involved in site development and redevelopment

including their engineers, planners, and construction staff; regulatory agencies including permit and planning staff; and the general public with an interest in stormwater pollution control.

## 1.1.2 Organization of the Handbook

The handbook is organized to assist the user in selecting and implementing BMPs to reduce impacts of stormwater and non-stormwater discharges on receiving waters. The handbook consists of the following sections:

<p><b>Section 1 Introduction</b> <i>This section provides a general review of the sources and impacts of urban stormwater discharges and provides an overview of the Federal and state programs regulating stormwater discharges.</i></p>	<p><b>Section 2 Stormwater Pollution Prevention Planning for New Development and Redevelopment</b> <i>This section describes typical permit requirements, planning principles, and site assessment. It also covers identifying BMPs, integrating BMPs into the project, maintaining BMPs, and preparing stormwater pollution control plans.</i></p>	<p><b>Section 3 Site and Facility Design for Water Quality Protection</b> <i>This section describes planning approaches to reduce, eliminate, control and treat runoff from development and redevelopment, and integration of BMPs into common site, drainage, and building features.</i></p>
<p><b>Section 4 Source Control BMPs</b> <i>BMP fact sheets presented in this section address structural source control BMPs to be considered for development and redevelopment.</i></p>	<p><b>Section 5 Treatment Control BMPs</b> <i>BMP fact sheets presented in this section address treatment control BMPs that may be used for development/ redevelopment sites.</i></p>	<p><b>Section 6 Long Term BMP Maintenance</b> <i>This section outlines approaches to maintain BMPs, monitor BMP effectiveness, and evaluate additional BMP requirements.</i></p>
<p><b>Section 7 Glossary and List of Acronyms</b> <i>This section identifies terms and abbreviations used in the handbooks.</i></p>	<p><b>Appendix B General Applicability of Effluent Probability Method</b> <i>This appendix discusses concerns about the general applicability of this probability technique.</i></p>	<p><b>Appendix C Effluent Concentrations of Additional Metals and Nutrients</b> <i>This appendix compares effluent concentrations of constituents not described in Section 5.</i></p>
<p><b>Appendix A Channel Impacts from Watershed Changes</b> <i>This appendix describes a stream balance equation affected by changes in runoff or sediment loads.</i></p>		<p><b>Appendix D Rain Intensity and BMP Sizing Curves</b> <i>This appendix includes rain intensity cumulative frequency curves and volume-based BMP sizing curves.</i></p>

### Project Lifecycle

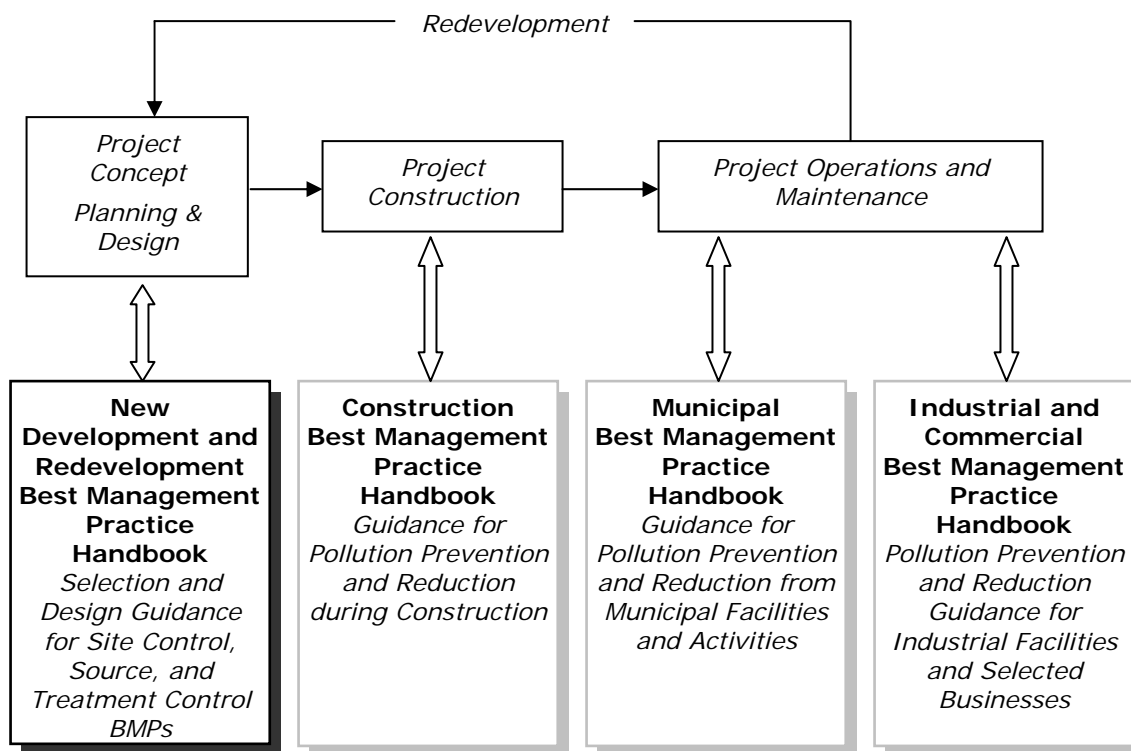

### 1.1.3 Relationship to Other Handbooks

This handbook is one of four handbooks developed by the California Stormwater Quality Association (CASQA) to address BMP selection. Collectively, the four handbooks address BMP selection throughout the life of a project – from planning and design – through construction – and into operation and maintenance. Individually, each handbook is geared to a specific target audience during each stage of a project.

This handbook, the New Development and Redevelopment Handbook, addresses selection and implementation of BMPs to eliminate or to reduce the discharge of pollutants associated with development and redevelopment activities.

For a comprehensive understanding of stormwater pollution control throughout the life cycle of the project, it is recommended that the reader obtain and become familiar with all four handbooks. Typically, municipal stormwater program managers, regulators, environmental organizations, and stormwater quality professionals will have an interest in all four handbooks. For a focused understanding of stormwater pollution control during a single phase of the project life cycle, a reader may obtain and become familiar with the handbook associated with the appropriate phase. Typically, contractors, construction inspectors, industrial site operators, commercial site operators, some regulators and some municipal staff may have an interest in a single handbook.

## 1.2 Stormwater Pollutants and Impacts on Water Quality

Stormwater runoff naturally contains numerous constituents, however, urbanization and urban activities including development and redevelopment typically increase constituent concentrations to levels that impact water quality. Pollutants associated with stormwater include sediment, nutrients, bacteria and viruses, oil and grease, metals, organics, pesticides, and trash (floatables). In addition, nutrient-rich stormwater runoff is an attractive medium for vector production when it accumulates and stands for more than 72 hours. Stormwater pollutants are described in Table 1-1.

Development and redevelopment activities can result in two types of water quality impacts: erosion and sedimentation and discharge of other pollutants during construction; and long term impacts from runoff from the completed development and associated land uses. Control of water quality impacts during construction is covered in the Construction edition of the Stormwater Best Management Practice Handbook. This handbook addresses potential water quality impacts from completed development that can include the following:

- Urban activities can result in the generation of new dry-weather runoff that may contain many of the pollutants listed above
- Impervious surfaces associated with development, such as streets, rooftops, and parking lots, prevent runoff infiltration and increase the rate and volume of stormwater runoff that may increase downstream erosion potential and associated potential water quality impairment
- Urban activities and increased impervious surfaces which can increase the concentration and/or total load of many of the pollutants listed above in wet weather stormwater runoff



<b>Table 1-1 Pollutant Impacts on Water Quality</b>	
<b>Sediment</b>	Sediment is a common component of stormwater, and can be a pollutant. Sediment can be detrimental to aquatic life (primary producers, benthic invertebrates, and fish) by interfering with photosynthesis, respiration, growth, reproduction, and oxygen exchange in water bodies. Sediment can transport other pollutants that are attached to it including nutrients, trace metals, and hydrocarbons. Sediment is the primary component of total suspended solids (TSS), a common water quality analytical parameter.
<b>Nutrients</b>	Nutrients including nitrogen and phosphorous are the major plant nutrients used for fertilizing landscapes, and are often found in stormwater. These nutrients can result in excessive or accelerated growth of vegetation, such as algae, resulting in impaired use of water in lakes and other sources of water supply. For example, nutrients have led to a loss of water clarity in Lake Tahoe. In addition, un-ionized ammonia (one of the nitrogen forms) can be toxic to fish.
<b>Bacteria and viruses</b>	Bacteria and viruses are common contaminants of stormwater. For separate storm drain systems, sources of these contaminants include animal excrement and sanitary sewer overflow. High levels of indicator bacteria in stormwater have led to the closure of beaches, lakes, and rivers to contact recreation such as swimming.
<b>Oil and Grease</b>	Oil and grease includes a wide array of hydrocarbon compounds, some of which are toxic to aquatic organisms at low concentrations. Sources of oil and grease include leakage, spills, cleaning and sloughing associated with vehicle and equipment engines and suspensions, leaking and breaks in hydraulic systems, restaurants, and waste oil disposal.
<b>Metals</b>	Metals including lead, zinc, cadmium, copper, chromium, and nickel are commonly found in stormwater. Many of the artificial surfaces of the urban environment (e.g., galvanized metal, paint, automobiles, or preserved wood) contain metals, which enter stormwater as the surfaces corrode, flake, dissolve, decay, or leach. Over half the trace metal load carried in stormwater is associated with sediments. Metals are of concern because they are toxic to aquatic organisms, can bioaccumulate (accumulate to toxic levels in aquatic animals such as fish), and have the potential to contaminate drinking water supplies.
<b>Organics</b>	Organics may be found in stormwater in low concentrations. Often synthetic organic compounds (adhesives, cleaners, sealants, solvents, etc.) are widely applied and may be improperly stored and disposed. In addition, deliberate dumping of these chemicals into storm drains and inlets causes environmental harm to waterways.
<b>Pesticides</b>	Pesticides (including herbicides, fungicides, rodenticides, and insecticides) have been repeatedly detected in stormwater at toxic levels, even when pesticides have been applied in accordance with label instructions. As pesticide use has increased, so too have concerns about adverse effects of pesticides on the environment and human health. Accumulation of these compounds in simple aquatic organisms, such as plankton, provides an avenue for biomagnification through the food web, potentially resulting in elevated levels of toxins in organisms that feed on them, such as fish and birds.
<b>Gross Pollutants</b>	Gross Pollutants (trash, debris, and floatables) may include heavy metals, pesticides, and bacteria in stormwater. Typically resulting from an urban environment, industrial sites and construction sites, trash and floatables may create an aesthetic “eye sore” in waterways. Gross pollutants also include plant debris (such as leaves and lawn-clippings from landscape maintenance), animal excrement, street litter, and other organic matter. Such substances may harbor bacteria, viruses, vectors, and depress the dissolved oxygen levels in streams, lakes, and estuaries sometimes causing fish kills.
<b>Vector Production</b>	Vector production (e.g., mosquitoes, flies, and rodents) is frequently associated with sheltered habitats and standing water. Unless designed and maintained properly, standing water may occur in treatment control BMPs for 72 hours or more, thus providing a source for vector habitat and reproduction (Metzger, 2002).

## 1.3 Regulatory Requirements

The Federal Clean Water Act, as amended in 1987, is the principal legislation for establishing requirements for the control of stormwater pollutants from urbanization and related activities. However, other federal, state, and local requirements deal directly or indirectly with controlling stormwater discharges. Requirements for stormwater under some of these programs, such as Basin Planning, Total Maximum Daily Loads (TMDLs), the California Environmental Quality Act (CEQA), 401 Water Quality Certifications and Endangered Species Act (ESA) are evolving, and the user is advised to contact local regulatory and/ or municipal officials for further information.

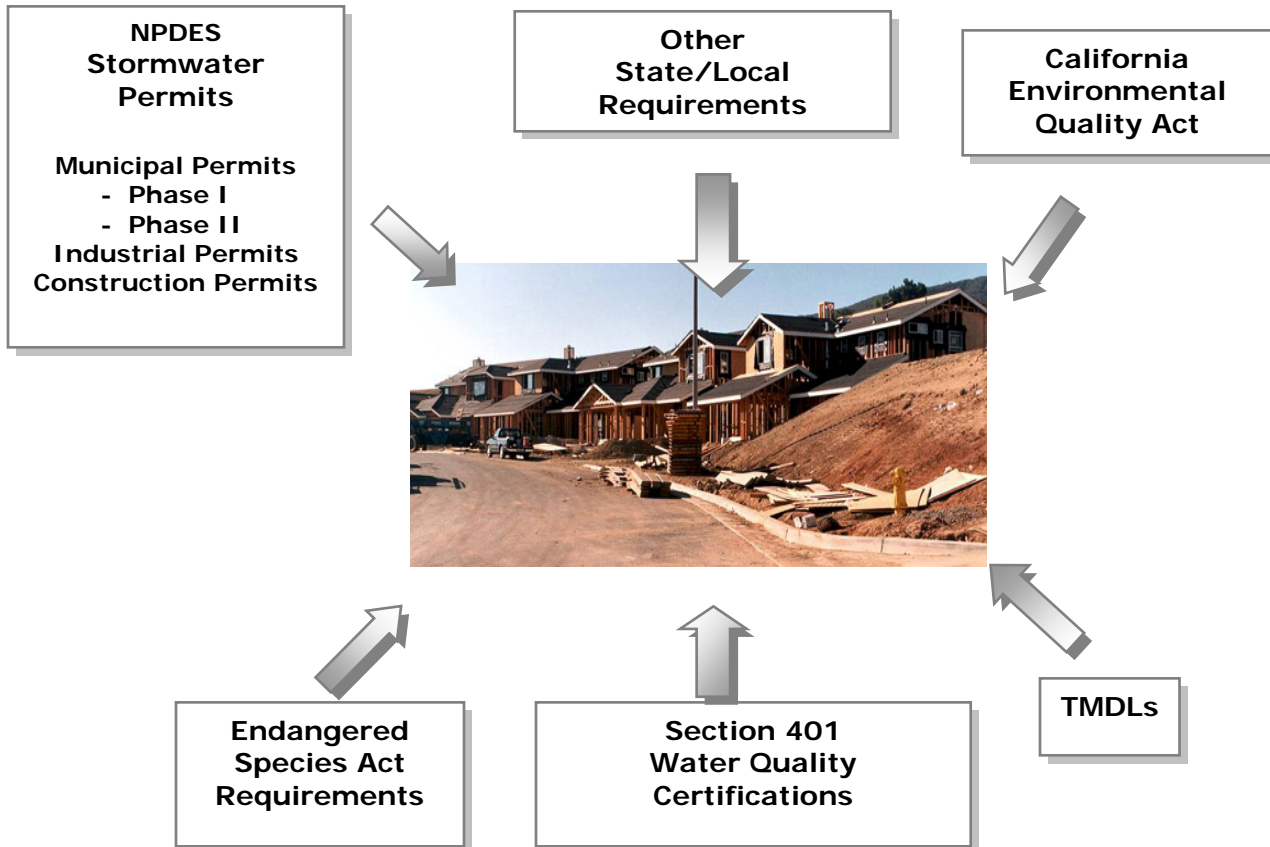

### 1.3.1 Federal Programs

In 1972, provisions of the Federal Water Pollution Control Act, also referred to as the Clean Water Act (CWA), were amended so that discharge of pollutants to waters of the United States from any point source is effectively prohibited, unless the discharge is in compliance with a National Pollutant Discharge Elimination (NPDES) permit. The 1987 amendments to the CWA added Section 402(p), which established a framework for regulating municipal, industrial, and construction stormwater discharges under the NPDES program. On November 16, 1990, USEPA published final regulations that established application requirements for stormwater permits for municipal separate storm sewer systems (MS4s) serving a population of over 100,000 (Phase I communities) and certain industrial facilities, including construction sites greater than 5 acres.

On December 8, 1999, USEPA published the final regulations for communities under 100,000 (Phase II MS4s) and operators of construction sites between 1 and 5 acres.

### 1.3.2 State Programs

The State Porter-Cologne Act (Water Code 13000, et seq.) is the principal legislation for controlling stormwater pollutants in California. The Act requires development of Basin Plans for drainage basins within California. Each plan serves as a blueprint for protecting water quality within the various watersheds. These basin plans are used in turn to identify more specific controls for discharges (e.g., wastewater treatment plant effluent, urban runoff, and agriculture drainage). Under Porter-Cologne, specific controls are implemented through permits called Waste Discharge Requirements issued by the nine Regional Water Quality Control Boards. For discharges to surface waters, the Waste Discharge Requirement also serves as NPDES permits.

### 1.3.3 Municipal NPDES Stormwater Programs

Phase I MS4s are required to obtain an individual NPDES stormwater permit and develop a stormwater management plan (SWMP) that is implemented by the municipality's stormwater management program. One of the elements of the municipal NPDES Stormwater Program are new development and redevelopment activities including: planning processes, design review, BMPs, outreach, and enforcement.

Smaller, Phase II communities are covered by a General Permit. Six Phase II measures are required in Phase II permits. One addresses post-construction stormwater management in new development and redevelopment, including developing, implementing, and enforcing a program to address discharges of stormwater runoff from new and redevelopment areas.

Phase I permits and the Phase II General Permit in California contain standard requirements for planning and design BMPs including minimum requirements for treatment of runoff from new development. These standards are called Standard Urban Stormwater Mitigation Plans (SUSMPs) in some permits, or equivalent terminology is used in others. These are discussed further in Section 2.

### 1.3.4 Other Relevant Regulatory Programs

In addition to meeting municipal stormwater program requirements under CWA section 402(p), municipalities are increasingly subject to other regulatory drivers that relate to the protection of surface water quality and beneficial uses of waterbodies in their communities. Several other regulatory programs that can significantly affect new development and redevelopment planning and design are:

- Total Maximum Daily Loads (TMDLs)
- Endangered Species Act
- CWA Section 404 Dredge and Fill Permits
- Section 401 Water Quality Certification

In the coming years, these regulatory drivers will likely have at least as much impact on the design and implementation of municipal stormwater programs and BMP selection and maintenance as current stormwater regulations.

### **TMDLs**

TMDL's are a regulatory mechanism to identify and implement additional controls on both point and non-point source discharges in water bodies that are impaired from one or more pollutants and are not expected to be restored through normal point source controls. States identify impairments and pollutants by putting impaired water bodies on a list as required under Section 303(d) of the CWA.

Stormwater or urban runoff is listed as a suspected source for many of the waterbody pollutant combinations in the current 303(d) list. Stormwater programs must be designed not only to be in compliance with the stormwater NPDES permit regulations, but they must also be designed to implement TMDLs in which stormwater or urban runoff is named as a source.

### **Endangered Species Act**

Like TMDLs, Endangered Species Act issues are becoming increasingly important to stormwater program design and implementation. The presence or potential presence of an endangered species impacts stormwater management programs and the selection and maintenance of BMPs. Although there are numerous endangered species that may impact the program, two that have particular impacts are salmon and steelhead trout.

The National Marine Fisheries Service (NMFS) has designated critical habitat for salmon and steelhead trout in large areas of the north and central coast and central valley of California.

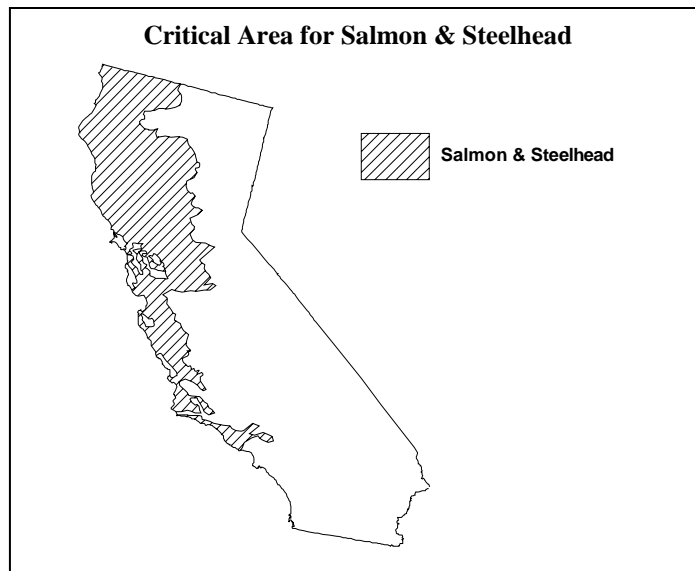

Developers or public agency intending to conduct activities in or discharge to an area that serves as a critical habitat must contact resource agencies such as NMFS, the US Fish & Wildlife Service, and the California Department of Fish & Game to learn about specific compliance requirements and actions.

### **CWA Section 401 Water Quality Certification**

In 1972, Section 404 of the Clean Water Act (CWA) was passed. It prohibits discharging dredged or fill material into U.S. waters without a permit from the Army Corps of Engineers (USACE). Subsequent court rulings and litigation further defined "Waters of the U.S." to include virtually all surface waters, including wetlands. A 1991 Supreme Court decision eliminated federal jurisdiction

based on Commerce factors over a poorly defined set of “isolated” waters; however, such waters remain subject to state jurisdiction under the Porter-Cologne Act. Activities in waters of the United States that are regulated under this program include fills for development, water resource projects (such as dams and levees), infrastructure development (such as highways and airports), and conversion of wetlands to uplands for farming and forestry.

The basic premise of the program is that no discharge of dredged or fill material is permitted if a practicable alternative exists that is less damaging to the aquatic environment or if the nation's waters would be significantly degraded. When applying for a permit, it must be shown that:

- Steps have been taken to avoid wetland impacts where practicable.
- Potential impacts to wetlands have been minimized.
- Compensation for any remaining, unavoidable impacts through activities has been provided to restore or create wetlands.

An individual permit is usually required for potentially significant impacts. However, for most discharges that will have only minimal adverse effects, the USACE often grants up-front general permits. These may be issued on a nationwide, regional, or state basis for particular categories of activities (for example, minor road crossings, utility line backfill, and bedding) as a means to expedite the permitting process.

Anyone proposing to conduct a project that requires a federal permit (404) or involves dredge or fill activities that may result in a discharge to U.S. surface waters and/or "Waters of the State" are required to obtain a CWA Section 401 Water Quality Certification and/or Waste Discharge Requirements (Dredge/Fill Projects) from the Regional Water Quality Control Board (RWQCB), verifying that the project activities will comply with state water quality standards. The rules and regulations apply to all "Waters of the State", including isolated wetlands and stream channels that may be dry during much of the year, have been modified in the past, look like a depression or drainage ditch, have no riparian corridor, or are on private land.

Section 401 of the CWA grants each state the right to ensure that the State's interests are protected on any federally permitted activity occurring in or adjacent to “Waters of the State”. In California, the nine RWQCBs are the agency mandated to ensure protection of the State's waters. If a proposed project requires a USACE, CWA Section 404 permit and has the potential to impact Waters of the State, the RWQCB will regulate the project and associated activities through a Water Quality Certification determination (Section 401), as part of the 404 process.

However, if a proposed project does not require a federal permit, but does involve dredge or fill activities that may result in a discharge to "Waters of the State", the RWQCB has the option to regulate the project under its state authority (Porter-Cologne) in the form of Waste Discharge Requirements or Waiver of Waste Discharge Requirements. In addition, California Department of Fish and Game (DFG) may regulate the project through the Streambed Alteration Agreement process. DFG issues Streambed Alteration Agreements when project activities have the potential to impact intermittent and perennial streams, rivers, or lakes.

Developers should be aware of these permits, and make arrangements with the appropriate agency to obtain a permit and comply with permit regulations.

## 1.4 Definitions

Many of the common definitions for stormwater control are found in the Glossary (see Section 7). Throughout the handbook the user will find references to the following terms:

**MS4** is a municipality owned separate storm sewer system. Operators of MS4s are usually permitted under Phase II of the NPDES program. NPDES is an acronym for National Pollutant Discharge Elimination System. NPDES is the national program for administering and regulating Sections 307, 318, 402 and 405 of the Clean Water Act (CWA).

A **Best Management Practice (BMP)** is defined as any program, technology, process, siting criteria, operating method, measure, or device, which controls, prevents, removes, or reduces pollution.

**Source Control BMPs** are operational practices that prevent pollution by reducing potential pollutants at the source. They typically do not require maintenance or construction.

**Source Control BMPs for design** are planning methods and concepts that should be taken into consideration by developers during project design.

Treatment Control BMPs are methods of treatment to remove pollutants from stormwater.

## 1.5 References and Resources

ASCE, 1998, *Urban Runoff Quality Management, Manual and Report of Engineering Practice 87*, Reston, Virginia.

ASCE, 2001, *Guide for Best Management Practice (BMP) Selection in Urban Developed Areas*, Reston, Virginia.

Bay Area Stormwater Management Agencies Association, 1999, *Start at the Source: Design Guidance Manual for Stormwater Quality Protection*. Consulting Engineers and Land Surveyors of California.

Brown, W., and T.R. Schueler, 1997, *National Pollutant Removal Performance Database for Stormwater BMPs*, Center for Watershed Protection, Elliott City, Maryland.

Clean Water Act Section 401- Water Quality Certification and/or Waste Discharge Requirements (Dredge/Fill Projects) [http://www.swrcb.ca.gov/rwqcb1/Program\\_Information/wqwetcert.html](http://www.swrcb.ca.gov/rwqcb1/Program_Information/wqwetcert.html)

Goldberg, Rob, 1993, *The Last Little Bit: The Goal of Zero Discharge*, Academy of Natural Sciences. <http://www.acnatsci.org/research/kye/discharge.html>

Horner, R., Skupien, J., Livingston, E., and Shaver, H., 1994, *Fundamentals of Urban Runoff Management: Technical and Institutional Issues*, Terrene Institute, Washington, DC.

Lane Equation, Rosgen 1996, from Lane, 1955. *The Importance of Fluvial Morphology in Hydraulic Engineering*. Proceedings ASCE, 81(745):1-17.

<http://www.epa.gov/watertrain/stream/s7.jpg>

Makepeace, D.K, D. W. Smith, and S. J. Stanley, 1995, *Urban Stormwater Quality: Summary of Contaminant Data*, in *Critical Reviews in Environmental Science and Technology*, 25, 293.

McLean, J. 2000. *Mosquitoes in Constructed Wetlands: a Management Bugaboo?* In T.R. Schueler and H.K. Holland [eds.], *The Practice of Watershed Protection*. pp. 29-33. Center for Watershed Protection, Ellicott City, MD.

Metzger, M.E., D.F. Messer, C.L. Beitia, C.M. Myers, and V.L. Kramer. 2002. *The Dark Side of Stormwater Runoff Management: Disease Vectors Associated with Structural BMPs*. *Stormwater* 3(2): 24-39.

Santana, F.J., J.R. Wood, R.E. Parsons, and S.K. Chamberlain. 1994. *Control of Mosquito Breeding in Permitted Stormwater Systems*. Sarasota County Mosquito Control and Southwest Florida Water Management District, Brooksville, FL., 46 pp.

Section 404 of the Clean Water Act: An Overview.

<http://www.epa.gov/owow/wetlands/facts/fact10.html>

Shoemaker, L., M. Lahlou, A. Doll, and P. Cazenias, 2000, *Stormwater Best Management Practices in Ultra-Urban Setting: Selection and Methodology*, Federal Highway Administration, FHWA-EP-00-002.

Stormwater Manager's Resource Center (SMRC) Website, 2002, Center for Watershed protection, Inc., Ellicott City, MD. <http://www.stomwatercenter.net>

USACE Regulatory Program: Section 404 of the Clean Water Act

<http://www.hq.usace.army.mil/cepa/pubs/wetland.htm>

U.S. Environmental Protection Agency, 1983, *Results of the Nationwide Urban Runoff Program*, PB84-185552, Washington, D.C.

U.S. Environmental Protection Agency, Watershed Academy Web Page, Stream Corridor Structure, <http://www.epa.gov/watertrain/stream/stream4.html>

Winer, R., 2000, *National Pollutant Removal Performance Database for Stormwater Treatment*, 2nd edition, Center for Watershed Protection, Elliott City, Maryland.





# Section 2

## Stormwater Quality Planning For New Development and Redevelopment

### 2.1 Introduction

State and Federal programs require BMPs to be implemented by developers, property owners, and public agencies engaged in new development or redevelopment activities. Understanding new development and redevelopment in the context of the project life cycle is important for proper selection and implementation of BMPs as shown in Figure 2-1. The concept, planning, and design phases of a project may be spread over a period of months to many years. BMPs incorporated into the concept, planning, and design phase are much more cost-effective than the retrofit of BMPs.

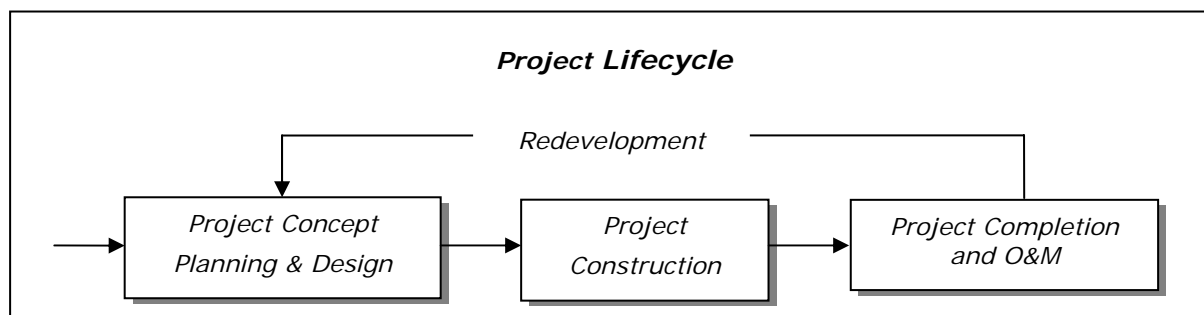

Figure 2-1  
Project Lifecycle

### 2.2 Permit Requirements

New development BMPs are required under NPDES permits shown in Figure 2-2. The intent of incorporating BMPs in new private development and public capital projects is to prevent any net detrimental change in runoff quantity or quality resulting from new development and redevelopment.

Typical permit requirements that are now being included in all Phase I MS4 permits and are incorporated in the Phase II General Permit include:

- Specific thresholds for “Priority Projects” that must include both source and treatment control BMPs in the completed projects (typical project thresholds are shown in Figure 2-3).

#### NPDES Stormwater Permit Requirements

**Phase I** areas (large urban areas and major industries)

- Under permits since early 1990s
- Individual municipal permits all include a program element for new development or “post construction” BMPs

**Phase II** areas (small urban areas and additional industries)

- Under General Permit since early 2003
- Permit includes new development requirements similar to Phase II.

Figure 2-2  
NPDES Stormwater Permit Requirements

Typical California Municipal Permit Thresholds for Treatment BMPs	
■ Residential $\geq$ 10 units	■ A list of source control (both non-structural and structural) BMPs and treatment control BMPs to be included or considered
■ Commercial $\geq$ 1 acre	■ Specific water quality design volume and/or water quality design flow rate for treatment control BMPs
■ Parking lots, road project $\geq$ 5,000 square feet	■ A requirement for flow control BMPs when there is potential for downstream erosion
■ Redevelopment $\geq$ 5,000 square feet impervious	■ Adopt a standard model or template for identifying and documenting selected BMPs including a plan for long-term operations and maintenance of BMPs
■ Retail Gasoline Outlets	
■ New and Redevelopment projects above 1 acre or 10,000 square feet of impervious area.	

**Figure 2-3**  
**Typical Treatment BMP Thresholds**

This standard model or template originated with the Los Angeles Municipal Stormwater permit and is called a Standard Urban Stormwater Mitigation Plan (SUSMP) under that and several other permits, although other terms such as Water Quality Management Plan (WQMP), Stormwater Quality Urban Impact Mitigation Plan, (SQUIMP), and C.3 Provisions have been used in other permits for equivalent programs. The SUSMPs list BMPs that are required for designated projects. Additional BMPs may be required by ordinance or code adopted by the Permittee and applied generally, or on a case-by-case basis. Private developers and public agencies must then include these SUSMP requirements in their project plans as applicable. Permittees then review and approve project plans as part of the development approved process for projects covered under SUSMP requirements.

Many of the permits also allow permittees to include the use of regional or watershed-based programs as alternatives to incorporating all of the BMPs to be on-site or project-based. Under this approach, programs would be developed and adopted that address specific water quality and pollutant concerns, achieve at least equivalent pollutant reduction that would have been required for all new development and redevelopment projects in the watershed through project-based BMPs, and can provide additional benefits by reducing impacts from existing developed areas. Where regional or watershed programs are developed, there will typically need to be a partnership between the planning agencies or permittees and the development community to clearly define the approach for satisfying the Permit requirements and evaluating choices between project-based and regional BMPs.

An effective mechanism for documenting the incorporation of stormwater quality controls into new development and redevelopment projects on a site, regional, or watershed basis is to develop a written plan known as a Stormwater Management Plan or SMP. An effective SMP clearly sets forth the means and methods for long-term stormwater quality protection. The SMP is a valuable document and can be used as part of the construction Stormwater Pollution Prevention Plan to describe post-construction stormwater management, and will also prove to

be useful during ownership transitions to convey critical stormwater quality control information to subsequent owners. Section 2.3 of this handbook describes the development of a stormwater management plan. Section 2.4 of this handbook describes planning principles appropriate for consideration during new development and redevelopment stormwater quality planning.

## 2.3 Developing a Stormwater Management Plan

Developing an effective stormwater management plan depends on making effective BMP choices. This section describes the basic steps and process one would go through to develop a plan with appropriate BMPs. Such a plan would include reviewing the full suite of BMPs that are available and identifying the dominant site factors that should go into the decision making process. Assessment of the regional area, specific site conditions, site constraints, site hydrology, and project type, are central to successful planning to minimize pollutants during development as well as during the life of the project. The basic steps in the stormwater management plan process are to:

- Assess site and watershed conditions
- Understand hydrologic conditions of concern
- Evaluate pollutants of concern
- Identify candidate BMPs
- Develop plan for BMP Maintenance

The specific requirements of a Stormwater Management Plan are usually specified by the local planning agency based on requirements in their MS4 permit. Typically, the following information is required:

### 2.3.1 Assess Site Conditions

Site and watershed assessment includes assessing and describing the pre and post-development site conditions and how the site fits into the overall watershed or drainage area. The assessment should include sufficient detail to allow for assessment of the need for and application of stormwater BMPs. Information typically required is listed below.

- Site information
  - Historic features
  - Existing features
  - Planned features
  - Drainage Patterns
  - Discharge Locations

- Vicinity information
  - Major roadways
  - Geographic features or landmarks
  - Area surrounding the site
  - General topography
  - Area drainage
- Watershed or drainage area information
  - Received waters
  - Watershed drainage

### 2.3.2 Understand Hydrologic Conditions of Concern

Development of impervious areas changes the landform and therefore the runoff hydrograph. Modifications to the runoff hydrograph change downstream hydrology. New development typically results in more runoff volume and higher rates of runoff. Many BMPs, such as detention basins, which detain volume, effectively remove the top part of the hydrograph, but extend the duration of flow. See Figure 2-4.

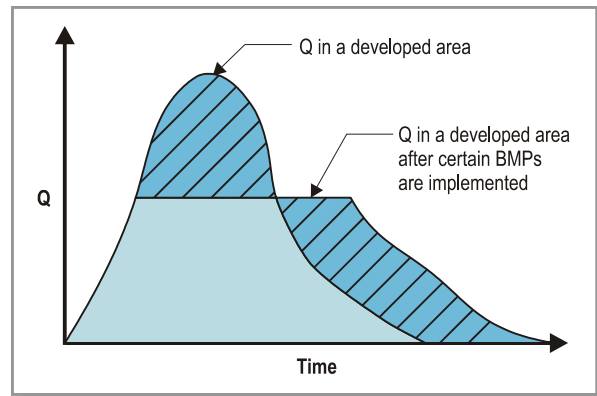

**Figure 2-4**  
**Hydraulic Alteration**  
**After Certain BMPs are Implemented**

Recent findings indicate that while such actions mitigate peak flows, the increased duration associated with these actions has impacts as well. Problems include washing out habitat, eroding streambed and banks, and changing downstream ecosystems. In addition to volume, rate, and duration, other factors such as the amount of energy in the water and peak flow impact downstream conditions.

A comprehensive understanding of these factors is necessary to develop meaningful stormwater management plans. To be effective, these solutions must be done on an individual watershed basis.

Ideally, the runoff hydrograph that exists after construction would parallel the pre-construction hydrograph. It is difficult to ask upstream developers to be concerned about what is happening several miles below them in a watershed. On the other hand, stormwater planners and policy makers must ask what can be done to make the watershed more stable, and what enhancements are needed to balance impacts to the watershed from development. A stream balance equation

can be used to make qualitative predictions concerning channel impacts due to changes in runoff or sediment loads from the watershed. This concept and the equation are described more fully in Appendix A.

The best way to resolve the watershed stability and balance issues is through a comprehensive drainage water master plan. A formal drainage study considers the project area's location in the larger watershed, topography, soil and vegetation conditions, percent impervious area, natural and infrastructure drainage features, and any other relevant hydrologic and environmental factors. A drainage study is typically prepared by a registered civil engineer. As part of the study, the drainage report includes:

- Field reconnaissance to observe downstream conditions
- Computed rainfall and runoff characteristics including a minimum of peak flow rate, flow velocity, runoff volume, time of concentration and retention volume
- Establishment of site design, source control and treatment control measures to be incorporated and maintained to address downstream conditions of concern

### **2.3.3 Evaluate Pollutants of Concern**

The stormwater management plan should identify anticipated pollutants of concern. Pollutants frequently identified in the 303d list for specific water bodies in California include metals, nitrogen, nutrients (but often nutrients without specifying nitrogen or phosphorus), indicator bacteria (i.e., fecal coliform), pesticides, and trash. Less commonly cited pollutants include sediment, PAHs, PCBs, and dioxin. With respect to metals, typically, only the general term is used. In some cases, a specific metal is identified. The most commonly listed metals are mercury, copper, lead, selenium, zinc, and nickel. Less frequently listed metals are cadmium, arsenic, silver, chromium, molybdenum, and thallium.

As discussed in Section 2.2, some Phase I communities have developed very prescriptive urban stormwater requirements. For example, the Los Angeles SUSMP requires permittees to develop a procedure for pollutants of concern to be identified for each new development or significant redevelopment project. The procedures should include, at a minimum, consideration of:

- receiving water quality (including pollutants for which receiving waters are listed as impaired under Clean Water Act section 303(d))
- land use type of the development project and pollutants associated with that land use type
- pollutants expected to be present on site;
- changes in stormwater discharge flow rates, velocities, durations, and volumes resulting from the development project
- sensitivity of receiving waters to changes in stormwater discharge flow rates, velocities, durations, and volumes.

A general list of anticipated and potential pollutants generated by land use type is shown in Table 2-1

It is important to realize that pollutants of concern for a water body can extend beyond those pollutants listed in 303d list as causing impairment. For example, trash is a pollutant of concern in most communities, yet only a few water bodies are presently listed as impaired by trash. The key to remember is that a pollutant need not be causing an immediate impairment to be considered when developing a stormwater management plan.

### **2.3.4 Identify Candidate BMPs**

Selecting BMPs based on pollutants of concern is a function of site constraints, constituents of concern, BMP performance, stringency of permit requirements, and watershed specific requirements such as TMDLs. Pollutants of concern are especially important in water limited stream segments and must be carefully reviewed in relationship to BMP performance. BMP performance is discussed further in Section 5.

When no specific pollutant has been targeted for removal, regulators may address pollutant removal through flow and /or volume-based requirements. Under these circumstances, cost can become an important differentiator in BMP selection. BMP specific cost information is included in Section 5.

Large reductions in treatment BMP size and investment can be made by:

- Reducing runoff that needs to be captured, infiltrated, or treated
- Controlling sources of pollutants

These two strategies are the most effective in managing stormwater. A third strategy includes implementation of treatment BMPs. The principles and methodologies for incorporating these strategies into site facility planning and design are discussed in Section 2.4 and Section 3, respectively. Fact Sheets for source control BMPs and treatment control BMPs are included in Section 4 and Section 5, respectively.

### **2.3.5 Determine BMP Size/Capacity**

Based on the selected BMPs, the capacity and primary design sizing criteria must be established using a combination of local hydrology, project drainage characteristics (e.g., percent imperviousness or runoff coefficient), and the local permit or New Development Program numerical sizing requirements. BMPs will be either volume-based or flow-based, as discussed in more detail later in this Handbook and must be able to effectively treat the design quantity. Peak storm event flows must also be taken into account if the BMP is a flow-based BMP, or a volume-based BMP that must also safely pass the design storm (e.g., an in-line detention basin). The volume-based BMP can safely pass the design peak event while maintaining its water quality functions up to the water quality design volume.

Table 2-1 Anticipated and Potential Pollutants Generated by Land Use Type										
Priority Project Categories	General Pollutant Categories									
	Pathogens	Heavy Metals	Nutrients	Pesticides	Organic Compounds	Sediments	Trash & Debris	Oxygen Demanding Substances	Oil & Grease	
Detached Residential Development	X		X	X		X	X	X	X	
Attached Residential Development	P		X	X		X	X	P <sup>(1)</sup>	P <sup>(2)</sup>	
Commercial/ Industrial Development >100,000 ft <sup>2</sup>	P <sup>(3)</sup>		P <sup>(1)</sup>	P <sup>(5)</sup>	P <sup>(2)</sup>	P <sup>(1)</sup>	X	P <sup>(5)</sup>	X	
Automotive Repair Shops		X			X <sup>(4)(5)</sup>		X		X	
Restaurants	X						X	X	X	
Hillside Development >5,000 ft <sup>2</sup> In SDRWQCB			X	X		X	X	X	X	
Hillside Development >100,000 ft <sup>2</sup> In SARWQCB			X	X		X	X	X	X	
Parking Lots		X	P <sup>(1)</sup>	P <sup>(2)</sup>		P <sup>(1)</sup>	X	Ps	X	
Streets, Highways & Freeways		X	P <sup>(1)</sup>		X <sup>(4)</sup>	X	X	P <sup>(5)</sup>	X	

X = anticipated

P = potential

(1) A potential pollutant if landscaping exists on-site

(2) A potential pollutant if the project includes uncovered parking areas

(3) A potential pollutant if land use involves food or animal waste products.

(4) Including petroleum hydrocarbons.

(5) Including solvents.

### 2.3.6 Develop Plan for BMP Maintenance

BMP maintenance arrangements take place during the planning phase of development and redevelopment projects. A permittee is committed to providing for water quality protection by requiring that a mechanism for ongoing, long-term maintenance of BMPs is in place. To ensure that BMP maintenance will take place, permittees require evidence that project proponents have executed an approved method of BMP maintenance, repair, and replacement before construction approvals are issued. Mechanisms used by permittees to assign responsibility for maintenance to public and private sector project proponents include:

- Covenants
- Maintenance Agreements
- Conditional use permits
- Deed restrictions
- Other legal agreements

The permittee requires that an Operation and Maintenance (O&M plan) be prepared by the project proponents. These plans are normally attached to approved maintenance agreements and describe a designated party to manage:

- BMPs
- Employee training program and duties
- Operating schedule
- Maintenance frequency
- Routine service schedule
- Specific maintenance activities
- Copies of resource agency permits
- Funding
- Other necessary activities

Permittees often require annual inspection and servicing of all BMPs within maintenance agreements, and O&M forms documenting all required maintenance activities. The party responsible for the O&M plan is required to retain O&M forms for at least five years.

A BMP maintenance plan is particularly valuable during ownership transitions. For example, when a developer transitions maintenance to a homeowners association, or when a developer turns over maintenance to a new owner, the BMP maintenance plan is also important when



valuating properties for acquisition, allowing long-term costs associated with BMPs to be factored into the property purchase agreement.

A more extensive discussion of long-term BMP maintenance is included in Section 6.

## 2.4 Planning Principles

Planning and design for water quality protection employs three basic strategies in the following order of relative effectiveness: 1) reduce or eliminate post-project runoff; 2) control sources of pollutants, and 3) treat contaminated stormwater runoff before discharging it to natural water bodies. See Figure 2-5. These principles are consistent with the typical permit and local program requirements for Priority Projects that require a consideration of a combination of source control BMPs (that reduce or eliminate runoff and control pollutant sources) and treatment control BMPs with specific quantitative standards. The extent to which projects can incorporate strategies that reduce or eliminate post project runoff will depend upon the land use and local site characteristics of each project. Reduction in post project runoff offers a direct benefit by reducing the required size of treatment controls to meet the numeric standard included in the local permit. Therefore, project developers can evaluate tradeoffs between the incorporation of alternative site design and source control techniques that reduce runoff and pollutants, and the size of required treatment controls either included as part of the project or as a commitment to an offsite watershed-based program.

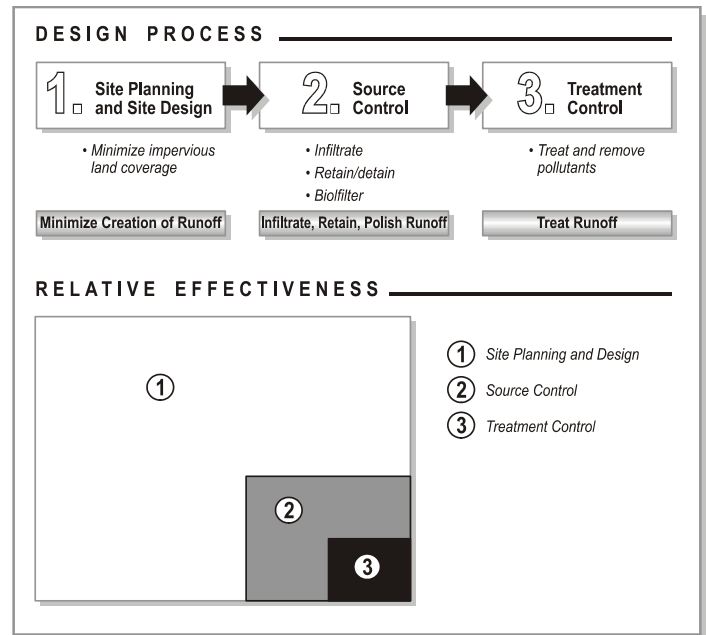

**Figure 2-5  
Planning Principles**

### 2.4.1 Reduce Runoff

The principle of runoff reduction starts by recognizing that developing or redeveloping land within a watershed inherently increases the imperviousness of the areas and therefore the volume and rate of runoff and the associated pollutant load; and outlines various approaches to reduce or minimize this impact through planning and design techniques.

The extent of impervious land covering the landscape is an important indicator of stormwater quantity and quality and the health of urban watersheds. Impervious land coverage is a fundamental characteristic of the urban and suburban environment -- rooftops, roadways, parking areas and other impenetrable surfaces cover soils that, before development, allowed rainwater to infiltrate.

Without these impervious coverings, inherent watershed functions would naturally filter rainwater and prevent receiving water degradation. Impervious surfaces associated with urbanization can cause adverse receiving water impacts in four ways:

- Rainwater is prevented from filtering into the soil, adversely affecting groundwater recharge and reducing base stream flows.
- Because it cannot filter into the soil, more rainwater runs off, and runs off more quickly, causing increased flow volumes, accelerating erosion in natural channels, and reducing habitat and other stream values. Flooding and channel destabilization often require further intervention. As a result, riparian corridors are lost to channelization, further reducing habitat values.
- Pollutants that settle on the impervious pavements and rooftops are washed untreated into storm sewers and nearby stream channels, increasing pollution in receiving water bodies.
- Impervious surfaces retain and reflect heat, increasing ambient air and water temperatures. Increased water temperature negatively impacts aquatic life and reduces the oxygen content of nearby water bodies.

Techniques for reducing runoff range from land use planning on a regional scale by permittees or other local planning agencies, to methods that can be incorporated into specific projects. These techniques include actions to:

- Manage watershed impervious area
- Minimize directly connected impervious areas
- Incorporate zero discharge areas
- Include self-treatment areas
- Consider runoff reduction areas.

Brief summaries of the following techniques are presented:

### **Manage Watershed Impervious Area**

Land use planning on the watershed scale is a powerful tool to manage the extent of impervious land coverage. This planning has two elements. First, identify open space and sensitive resource areas at the regional scale and target growth to areas that are best suited to development, and second, plan development that is compact to reduce overall land conversion to impervious surfaces and reliance on land-intensive streets and parking systems.

Impervious land coverage is a practical measure of environmental quality because:

- It is quantifiable, meaning that it can be easily recognized and calculated.

- It is integrative, meaning that it can estimate or predict cumulative water resource impacts independent of specific factors, helping to simplify the intimidating complexity surrounding non-point source pollution.
- It is conceptual, meaning that water resource scientists, municipal planners, landscape architects, developers, policy makers and citizens can easily understand it.

Water resource protection at the local and regional level is becoming more complex. A wide variety of regulatory agencies, diverse sources of non-point source pollution, and a multitude of stakeholders make it difficult to achieve a consistent, easily understandable strategy for watershed protection. Impervious land coverage is a scientifically sound, easily communicated, and practical way to measure the impacts of new development on water quality.

Impervious area reductions also provide additional benefits such as reduced urban heat island effect, resulting in less energy use to cool structures and more efficient irrigation use by plants. Reductions have also been attributed to more human-scale landscaper and higher property values.

### **Minimize Directly Connected Impervious Areas (DCIA)**

Impervious areas directly connected to the storm drain system are the greatest contributor to non-point source pollution. The first effort in site planning and design for stormwater quality protection is to minimize the “directly connected impervious area (DCIA)” as shown in Figure 2-6.

Any impervious surface that drains into a catch basin, area drain, or other conveyance structure is a “directly connected impervious area.” As stormwater runoff flows across parking lots, roadways, and paved areas, the oils, sediments, metals and other pollutants are collected and concentrated. If this runoff is collected by a drainage system and carried directly along impervious gutters or in closed underground pipes, it has no opportunity for filtering by plant material or infiltration into the soil. It also increases in speed and volume, which may cause higher peak flows downstream, and may require larger capacity storm drain systems, increasing flood and erosion potential.

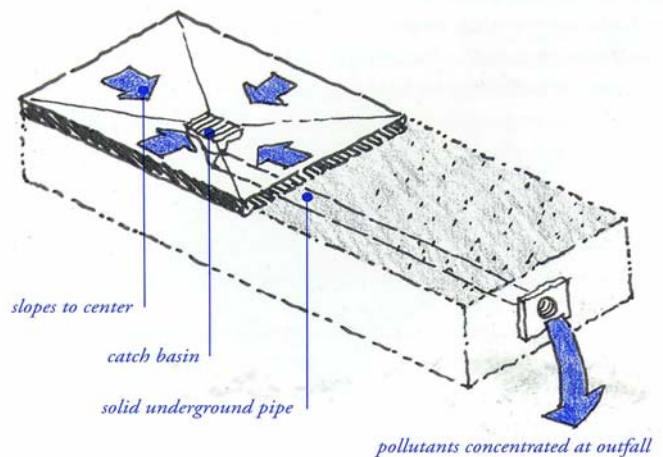

**Figure 2-6**  
**Directly Connected Impervious Area**

Minimizing directly connected impervious areas can be achieved in two ways:

- Limiting overall impervious land coverage
- Directing runoff from impervious areas to pervious areas for infiltration, retention/detention, or filtration

Strategies for reducing impervious land coverage include:

- Cluster rather than sprawl development
- Taller narrower buildings rather than lower spreading ones
- Sod or vegetative “green roofs” rather than conventional roofing materials
- Narrower streets rather than wider ones
- Pervious pavement for light duty roads, parking lots and pathways

Example strategies for infiltration, retention/detention, and bio-filtration include:

- Vegetated swales
- Vegetated basins (ephemeral- seasonally wet)
- Constructed ponds and lakes (permanent- always wet)
- Crushed stone reservoir base rock under pavements or in sumps
- Cisterns and tanks
- Infiltration basins
- Drainage trenches
- Dry wells
- Others

Unlike conveyance storm drain systems that convey water beneath the surface and work independently of surface topography, a drainage system for stormwater infiltration can work with natural landforms and land uses to become a major design element of a site plan. Solutions that reduce DCIA prevent runoff, detain or retain surface water, attenuate peak runoff rates, benefit water quality and convey stormwater. Site plans that apply stormwater management techniques use the natural topography to suggest the drainage system, pathway alignments, optimum locations for parks and play areas, and the most advantageous locations for building sites. In this way, the natural landforms help to generate an aesthetically pleasing urban form integrated with the natural features of the site.

### **Incorporate Zero Discharge Areas**

An area within a development project can be designed to infiltrate, retain, or detain the volume of runoff requiring treatment from that area.

The term “zero discharge” in this philosophy applies at stormwater treatment design storm volumes. For example, consider an area that functionally captures and then infiltrates the 80th

percentile storm volume. If permits require treatment of the 80th percentile storm volume, the area generates no treatment-required runoff.

Site design techniques available for designing areas that produce no treatment-required runoff include:

- Retention/Detention Ponds
- Wet Ponds
- Infiltration Areas
- Large Fountains
- Retention Rooftops
- Green roofs (roofs that incorporate vegetation) and blue roofs (roofs that incorporate detention or retention of rain).

Infiltration areas, ponds, fountains, and green/blue roofs can provide “dual use” functionality as stormwater retention measures and development amenities. Detention ponds and infiltration areas can double as playing fields or parks. Wet ponds and infiltration areas can serve dual roles when meeting landscaping requirements.

When several “zero discharge” areas are incorporated into a development design, significant reductions in volumes requiring treatment may be realized.

“Zero discharge” areas such as wet ponds, detention ponds, and infiltration areas can be designed to provide treatment over and above the storm volume captured and infiltrated. For example, after a wet pond area has captured its required storm volume, additional storm volume may be treated via settling prior to discharge from the pond. In this case, the “zero discharge” area converts automatically into a treatment device for runoff from other areas, providing settling for storm volumes beyond treatment requirements. Another example is a grassy infiltration area that converts into a treatment swale after infiltrating its area-required treatment volume. The grassy infiltration area in this example becomes a treatment swale for another area within the development.

Figure 2-7 illustrates a residential tract, and a tract incorporating Zero Discharge Area techniques (infiltration areas). The Zero Discharge Area designed tract represents a design to infiltrate (i.e., achieve zero discharge from) a portion of the tract’s runoff, reducing total runoff from the tract.

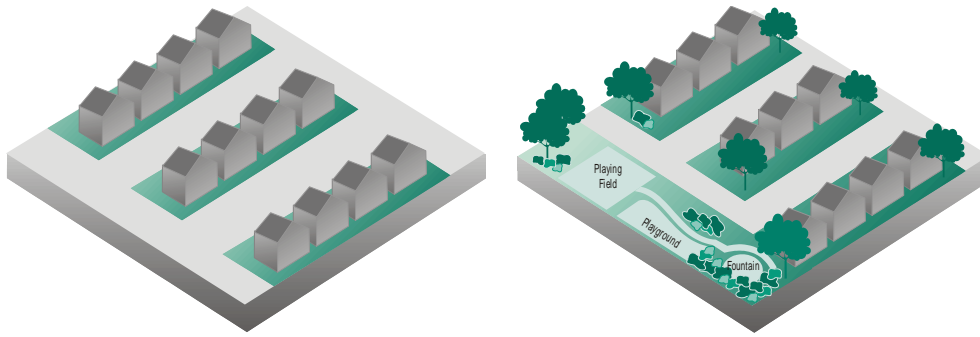

**Figure 2-7**  
**Zero Discharge Area Usage**

### **Include Self-Treatment Areas**

Developed areas may provide “self-treatment” of runoff if properly designed and drained.

Self-treating site design techniques include:

- Conserved Natural Spaces
- Large Landscaped Areas (including parks and lawns)
- Grass/Vegetated Swales
- Turf Block Paving Areas

The infiltration and bio-treatment inherent to such areas provides the treatment control necessary. These areas therefore act as their own BMP, and no additional BMPs to treat runoff should be required.

As illustrated in Figure 2-8, site drainage designs must direct runoff from self-treating areas away from other areas of the site that require treatment of runoff. Otherwise, the volume from the self-treating area will only add to the volume requiring treatment from the impervious area.

Likewise, under this philosophy, self-treating areas receiving runoff from treatment-required areas would no longer be considered self-treating, but rather would be considered as the BMP in place to treat that runoff. These areas could remain as self-treating, or partially self-treating areas, if adequately sized to handle the excess runoff addition.

### **Consider Runoff Reduction Areas**

Using alternative surfaces with a lower coefficient of runoff or “C-Factor” may reduce runoff from developed areas. The C-Factor is a representation of the surface’s ability to produce runoff. Surfaces that produce higher volumes of runoff are represented by higher C-Factors, such as impervious surfaces. Surfaces that produce smaller volumes of runoff are represented by lower C-Factors, such as more pervious surfaces. See Table 2-2 for typical C-Factor values for various surfaces during small storms.

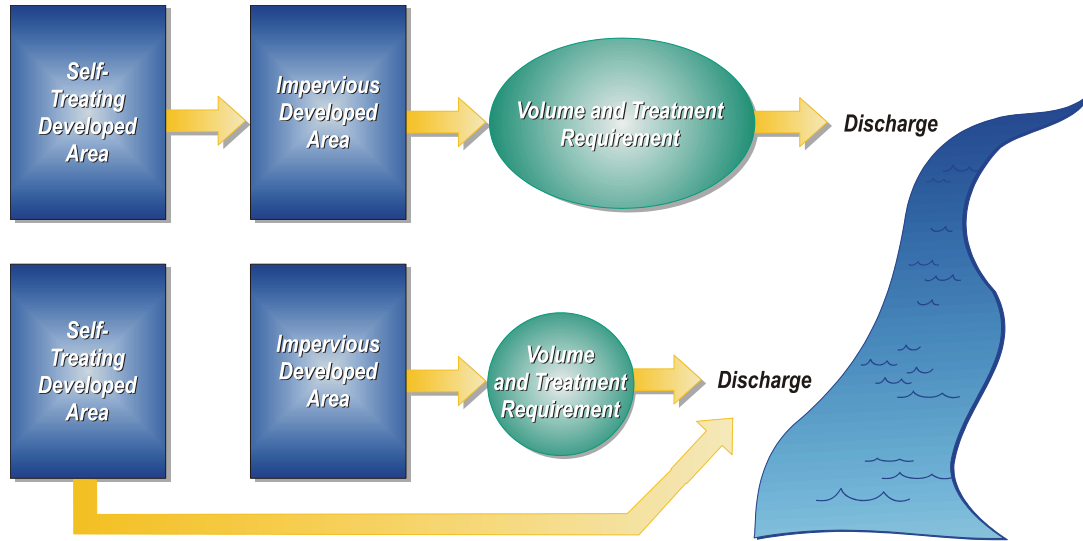

**Figure 2-8  
Self-Treating Area Usage**

<b>Paving Surface</b>	<b>C-Factor</b>
Concrete	0.80
Asphalt	0.70
Pervious Concrete	0.60
Cobbles	0.60
Pervious Asphalt	0.55
Natural Stone without Grout	0.25
Turf Block	0.15
Brick without Grout	0.13
Unit Pavers on Sand	0.10
Crushed Aggregate	0.10
Grass	0.10
Grass Over Porous Plastic	0.05
Gravel Over Porous Plastic	0.05

Note: C-Factors for small storms are likely to differ (be lower) than C-Factors developed for large, flood control volume size storms. The above C-Factors were produced by selecting the lower end of the best available C-Factor range for each paving surface. These C-Factors are only appropriate for small storm treatment design, and should not be used for flood control sizing. Where available, locally developed small storm C-Factors for various surfaces should be utilized.

Table 2-3 compares the C-Factors of conventional paving surfaces to alternative, lower C-Factor paving surfaces. By incorporating more pervious, lower C-Factor surfaces into a development (see Figure 2-9), lower volumes of runoff may be produced. Lower volumes and rates of runoff translate directly to lower treatment requirements.

<b>Conventional Paving Surface C-Factors</b>	<b>Reduced C-Factor Paving Alternatives</b>
Concrete Patio/Plaza (0.80)	Decorative Unit Pavers on Sand (0.10)
Asphalt Parking Area (0.70)	Turf Block Overflow Parking Area (0.15)
	Pervious Concrete (0.60)
	Pervious Asphalt (0.55)
	Crushed Aggregate (0.10)

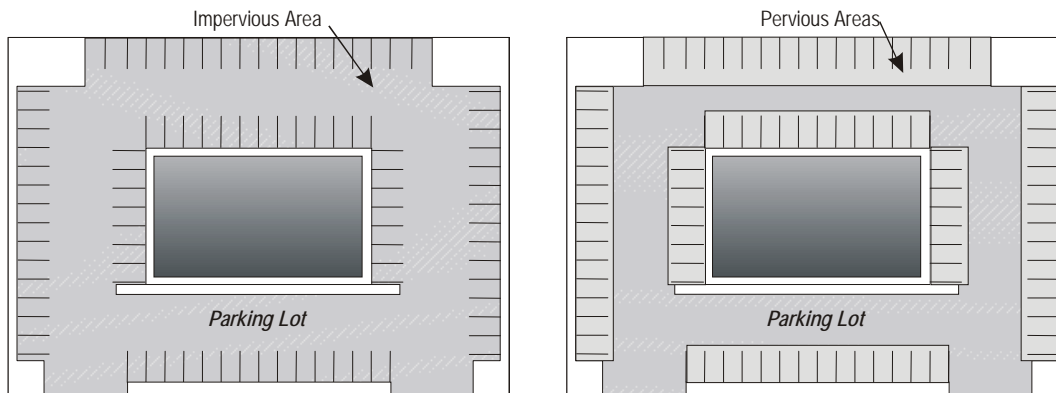

**Figure 2-9**  
**Impervious Parking Lot vs. Parking Lot with Some Pervious Surfaces**

Site design techniques that incorporate pervious materials may be used to reduce the C-Factor of a developed area, reducing the amount of runoff requiring treatment. These materials include:

- Pervious Concrete
- Pervious Asphalt
- Turf Block
- Brick (un-grouted)
- Natural Stone
- Concrete Unit Pavers
- Crushed Aggregate
- Cobbles
- Wood Mulch

Other site design techniques such as disconnecting impervious areas, preservation of natural areas, and designing concave medians may be used to reduce the overall C-Factor of development areas.

Table 2-4 presents a list of site design and landscaping techniques and indicates whether they are applicable for use in Zero Discharge Areas, Self-Treating Areas, and Runoff Reduction Areas. Several different techniques may be implemented within the same design philosophy. Some techniques may be used to implement more than one design philosophy. Where feasible, combinations of multiple techniques may be incorporated into new development and redevelopment projects to minimize the amount of treatment required.



<b>Table 2-4 Site Design and Landscaping Techniques</b>					
<b>Site Design and Landscape Techniques</b>	<b>Design Criteria</b>		<b>Design Philosophy</b>		
	<b>Volume-Based Design</b>	<b>Flow-Based Design</b>	<b>Zero Discharge</b>	<b>Self – Treating</b>	<b>Runoff Reduction</b>
<b>Permeable Pavements</b>					
Pervious concrete	X				X
Pervious asphalt	X				X
Turf block	X			X	X
Un-grouted brick	X				X
Un-grouted natural stone	X				X
Un-grouted concrete unit pavers	X				X
Unit pavers on sand	X				X
Crushed aggregate	X				X
Cobbles	X				X
Wood mulch	X				X
<b>Streets</b>					
Urban curb/swale system	X	X			X
Rural swale system	X	X			X
Dual drainage systems	X	X			X
Concave median	X	X	X		X
Pervious island	X	X			X
<b>Parking Lots</b>					
Hybrid surface parking lot	X				X
Pervious parking grove	X				X
Pervious overflow parking	X			X	X
<b>Driveways</b>					
Not directly connected impervious driveway		X			X
Paving only under wheels	X			X	X
Flared driveways	X				X
<b>Buildings</b>					
Dry-well	X		X		X
Cistern	X	X	X		X
Foundation planting	X	X			X
Pop-up drainage emitters		X			
<b>Landscape</b>					
Grass/vegetated swales	X	X		X	X
Extended detention (dry) ponds	X		X	X	X
Wet ponds	X		X	X	X
Bio-retention areas	X		X	X	X

## 2.4.2 Control Sources of Pollutants

There are a number of items that can be routinely designed into a project that function as source controls once a project is completed. They include such items as marking new drain inlets and posting informational signs; improving landscape planning and efficient irrigation methods; using water quality friendly building materials; implementing roof runoff controls; properly designing outdoor material and trash storage areas; and permanently protecting slopes and channels from erosion. They also include design features for specific workplace or other activity areas such as vehicle washing areas, outdoor processing areas, maintenance bays and docks, and fueling areas.

Design of BMPs to control workplace exposure to pollutants is guided by three general principles:

- Prevent water from contacting work areas. Work and storage areas should be designed to prevent stormwater runoff from passing through shipping areas, vehicle maintenance yards, and other work places before it reaches storm drains. The objective is to prevent the discharge of water laden with grease, oil, heavy metals and process fluids to surface waters or sensitive resource areas.
- Prevent pollutants from contacting surfaces that come into contact with stormwater runoff. Precautionary measures should be employed to keep pollutants from contacting surfaces that come into contact with runoff. This means controlling spills and reviewing operational practices and equipment to prevent pollutants from coming into contact with storm or wash water runoff.
- Treating water before discharging it to the storm drain. Treatment of polluted runoff should be employed as a last resort. If source control options are not possible, treatment measures that comply with NPDES permit requirements must be adopted.

Once BMPs are designed into a project, they must be appropriately operated and maintained throughout the life cycle of the project in order to accomplish the BMPs pollution control objectives. For information on post construction operation and maintenance of BMPs built into the project, the reader is referred to the Stormwater Best Management Practice Handbook – Industrial and Commercial, companions to this handbook.

## 2.4.3 Treat Runoff

Until recently, stormwater and street design systems were designed to achieve a single objective – to convey water off-site as quickly as possible. The primary concern of conveyance systems was to protect property from flooding during large, infrequent storms. Drainage systems designed to meet this single volume control objective fail to address the environmental effects of non-point source pollution and increases in runoff volume and velocity caused by development.

Today's drainage systems must meet multiple purposes: protect property from flooding, control stream bank erosion, and protect water quality. To achieve this, designers must integrate conventional flood control strategies for large, infrequent storms with stormwater quality control strategies.

There are several basic water quality strategies for treating runoff:

- Infiltrate runoff into the soil
- Retain/detain runoff for later release with the detention providing treatment
- Convey runoff slowly through vegetation
- Treat runoff on a flow-through basis using various treatment technologies

Solutions should be based on an understanding of the water quality and economic benefits inherent in construction of systems that utilize or mimic natural drainage patterns. Site designs should be based on site conditions and use these as the basis for selecting appropriate stormwater quality controls. The drainage system design process considers variables such as local climate, the infiltration rate and erosivity of the soils, and slope. Many of the negative impacts associated with urban development can be alleviated if policy alternatives encourage developers to protect and restore habitat quality and quantity, include measures to improve water quality, and provide buffers between development and stream corridors.

Unlike conveyance models, which are assessed by simple quantitative measures (flood control volumes and economics), water quality designs must optimize for a complex array of both quantitative and qualitative standards, including engineering worthiness, environmental benefit, horticultural sustainability, aesthetics, functionality, maintainability, economics and safety.

#### **2.4.4 Planning Development Strategies in Practice**

The importance of site planning in stormwater quality protection is illustrated in the following examples of development strategies: conventional residential subdivision (Figure 2-10, Alternative 1), conventional subdivision employing BMPs (Figure 2-11, Alternative 2), and a mixed-use transit-oriented development (Figure 2-12, Alternative 3). All three examples are intended to accommodate approximately 660 housing units on a 220-acre site adjacent to a creek.

The conventional residential subdivision (Alternative 1) accommodates 660 single-family homes on individual lots. One-sixth acre lots are accessed by a network of 40 ft wide cul-de-sac streets, with 5 ft sidewalks adjacent to the curb on each side of the street. The street and sidewalks are located within a 60 ft right-of-way, which is covered with a 40 ft wide street and two 5 ft sidewalks, or 50 ft of pavement, 100% impervious land coverage (streets only), and no room for street trees. No variation exists in housing types (all single-family).



**Figure 2-10**  
**Alternative 1: Conventional**

Both the streets and the open space features lack structure or hierarchy. The few direct connections through the neighborhood result in long stretches of overly wide streets that discourage walking.

Conventional development design does not use the recreational or stormwater benefits of the available open space and does not respond to natural and topographic features. Preservation of open space is a low priority, and the setback between the development and the creek is minimal. The remaining open space character is remnant space offering residents no creek access or parks. Stormwater travels through a 15,000 ft network of drainpipes and in the absence of current permit requirements would discharge untreated runoff directly into the creek. However, applying typical permit requirements, the development would still be required to incorporate runoff treatment for the water quality design volume defined in the local permit or MS4 new development program. For example, if the permit required treatment of the runoff from 0.75 inches of rainfall, the development as planned had an overall percent impervious value of 45%, and the designer was considering the use of an extended detention basin for treatment, this would require a treatment volume of approximately 6.2 ac-ft. Based on typical detention basin design practices, this could result in the need to dedicate approximately 2-3 acres of land, or the equivalent of approximately 12-18 lots to incorporate the basin into the development near the point where drainage enters the creek. Alternatively, if a watershed or regional master plan for water quality had been adopted in which the development could participate financially, the

project would contribute financially based on its required treatment volume and the cost allocation plan for the watershed program.

The hybrid/best practices subdivision (Alternative 2) illustrates a conventional neighborhood that applies some stormwater management practices. This attempt accommodates 660 single-family homes on individual lots. Streets are narrower, with the interior access streets at 28 ft wide, while internal neighborhood collectors are 32 ft wide. All streets have detached sidewalks that accommodate street trees planted between the sidewalk and the curb. This development sets the houses 100 ft back from the creek and offers residents 12 acres of access to open space and parks. The overall imperviousness has been reduced to about 41%, thereby reducing the volume to be treated to approximately 5.6 ac-ft. A detention basin has been created in open space within the development. Nearly one fourth of the 13,000 ft network of piped stormwater drains to a detention pond.

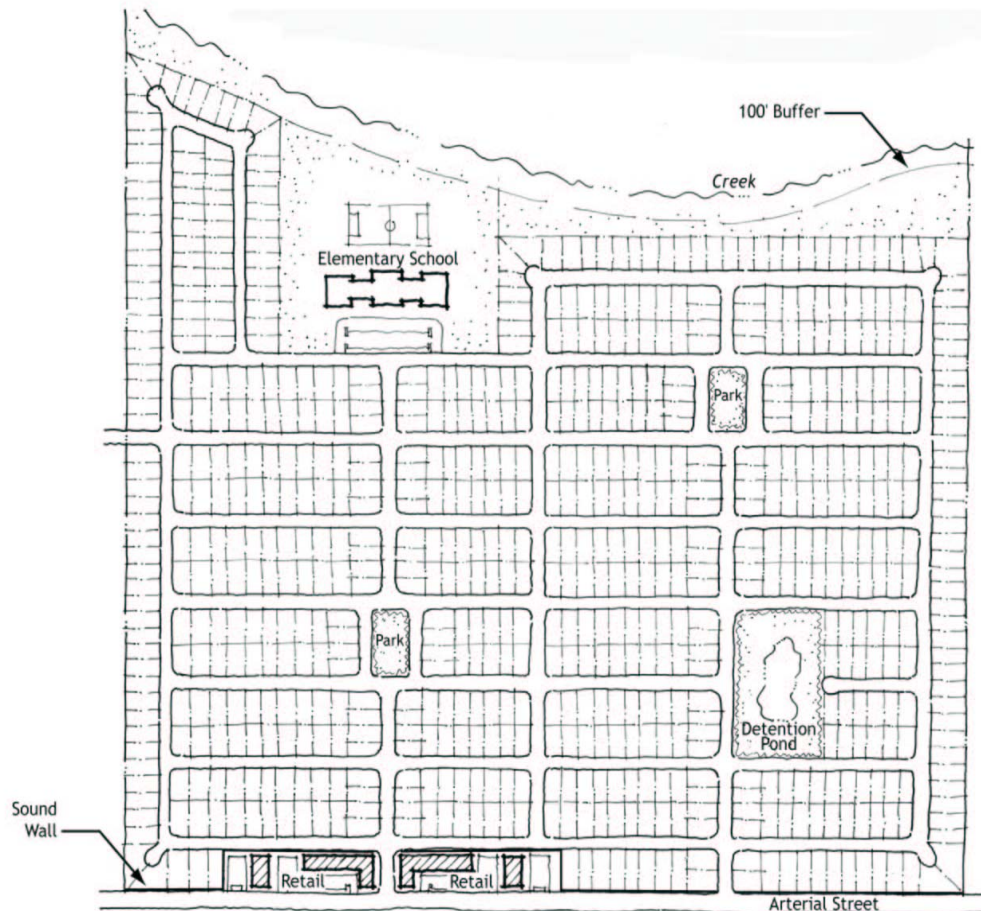

**Figure 2-11**  
**Alternative 2: Hybrid/Best Practices**

By employing a hierarchy of narrower streets this neighborhood requires 1475 ft<sup>2</sup> of street per housing unit, a reduction of 19% relative to the conventional sub-division.

The neo-traditional mixed-use neighborhood is illustrated as Alternative 3. This neighborhood includes 660 housing units, but also introduces other uses: retail, office, and live-work, within a network of tree-lined streets and open space. The neighborhood drains to an open space park adjacent to the creek, naturally and efficiently filtering stormwater before it enters the creek. Bioswales along key streets capture and treat stormwater en-route to the creek, providing aesthetic appeal and recreational opportunities. Alternative 3 requires 965 ft<sup>2</sup> of street per housing unit, a reduction of 47% relative to the conventional sub-division. A strategically located transit system stops near shops and higher density housing makes transit feasible. Every dwelling unit in the neighborhood is within a 5-minute walk from shops or transit. The overall imperviousness of this site has been reduced to approximately 36%, further reducing the treatment volume. In addition, there are a variety of opportunities to incorporate treatment for all of the remaining runoff within the open space park without the need to dedicate any additional developable land.

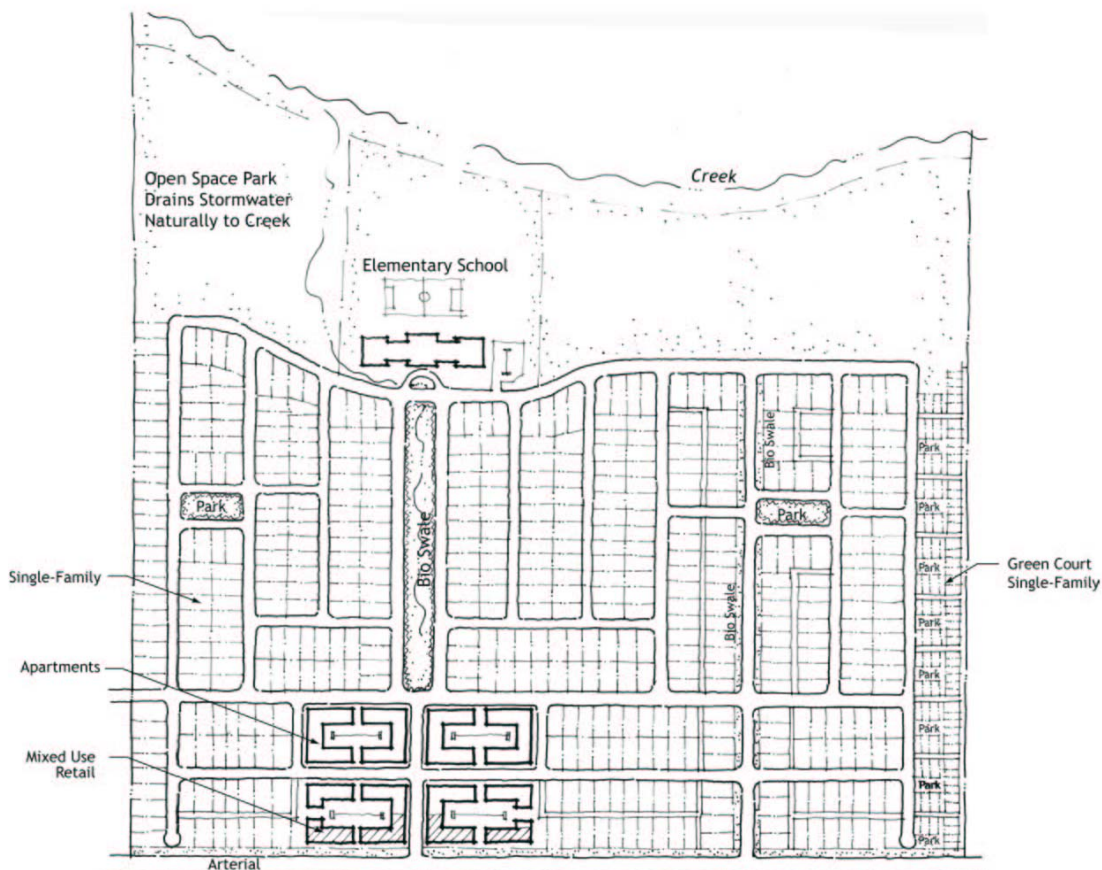

Figure 2-12  
Alternative 3: Neo-Traditional

A comparison of the three alternatives is shown in Table 2-5.

<b>Table 2-5 Comparison of Three Alternatives</b>			
	<b>Alternative 1</b>	<b>Alternative 2</b>	<b>Alternative 3</b>
Total Site (Ac)	220	220	220
# Of Housing Units	660	660	660
Parks & Open Space (Ac)	0	12	52
Creek Setback (Ft)	0	100	500
Impervious Land Coverage - Streets (Ac)	28	22	15
% Of Site that is Impervious - Streets Only	13%	10%	7%
% Of Site that is Impervious - Streets Only (Relative to Conventional)	100%	81%	53%
Linear Feet of Pipe	15,000	13,000	10,000
Linear Feet of Swale	0	0	4,700
Width of Major Streets (Ft)	40	32	32
Width of Minor Streets (Ft)	None	28	28

Typical lots in Alternatives 2 and 3 are illustrated in three forms: street loaded, alley fed and rural. In the street-loaded form, lot size is still approximately 1/6 acre, but the lot is narrower and deeper, thus reducing the amount of street frontage per household. The two-car garage is accessed from a front driveway. This front-loaded street accounts for 63% impervious land coverage in the 60 ft right-of-way.

Looking at a typical street, the traditional residential neighborhood reduces the number of feet of street and sidewalk per housing unit by nearly 40% compared to the conventional subdivision. This is accomplished by two means: a narrower street width (28 ft versus 40 ft), and narrower, deeper lots (60 ft versus 65 ft wide). Narrower lots mean less street frontage per lot.

In the alley-loaded form, the street right-of-way is narrowed to 50 ft, leaving 4 ft for trees between the sidewalk and curb. This form also employs the narrower street, achieving a 40% reduction in pavement dedicated to street and sidewalk. A 16 ft wide alley is provided in the back to access a garage at the rear of each lot. Additional pavement for the alley is balanced by elimination of pavement for the front driveway. This model assumes an impervious asphalt or concrete alley. Gravel alleys are feasible, and improve permeability. In this form, narrower, deeper lots are employed to accommodate the depth required for the alley.

The rural street form dramatically reduces impervious land coverage. The street is 19 ft wide with gravel shoulders for trees and parking. Pedestrians walk on the gravel shoulder or share the street with slow-moving cars.

*Section 2*

*Stormwater Quality Planning For New Development and Redevelopment*

Looking at a typical street, the rural form provides the greatest reduction in impervious land coverage. Only 570 ft<sup>2</sup> of pavement of street is required per housing unit, a reduction of 62% compared to the conventional sub-division.



# Section 3

## Site and Facility Design for Water Quality Protection

### 3.1 Introduction

Site and facility design for stormwater quality protection employs a multi-level strategy. The strategy consists of: 1) reducing or eliminating post-project runoff; 2) controlling sources of pollutants; and 3), if still needed after deploying 1) and 2), treating contaminated stormwater runoff before discharging it to the storm drain system or to receiving waters.

This section describes how elements 1), 2), and 3) of the strategy can be incorporated into the site and facility planning and design process, and by doing so, eliminating or reducing the amount of stormwater runoff that may require treatment at the point where stormwater runoff ultimately leaves the site. Elements 1) and 2) may be referred to as “source controls” because they emphasize reducing or eliminating pollutants in stormwater runoff at their source through runoff reduction and by keeping pollutants and stormwater segregated. Section 4 provides detailed descriptions of the BMPs related to elements 1) and 2) of the strategy. Element 3) of the strategy is referred to as “treatment control” because it utilizes treatment mechanisms to remove pollutants that have entered stormwater runoff. Section 5 provides detailed descriptions of BMPs related to element 3) of the strategy. Treatment controls integrated into and throughout the site usually provide enhanced benefits over the same or similar controls deployed only at the “end of the pipe” where runoff leaves the project site.

### 3.2 Integration of BMPs into Common Site Features

Many common site features can achieve stormwater management goals by incorporating one or more basic elements, either alone or in combination, depending on site and other conditions. The basic elements include infiltration, retention/detention, biofilters, and structural controls. This section first describes these basic elements, and then describes how these elements can be incorporated into common site features.

#### Infiltration

Infiltration is the process where water enters the ground and moves downward through the unsaturated soil zone. Infiltration is ideal for management and conservation of runoff because it filters pollutants through the soil and restores natural flows to groundwater and downstream water bodies. See Figure 3-1.

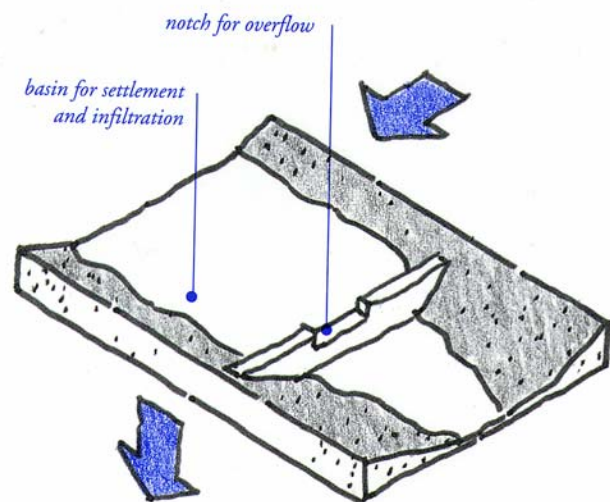

Figure 3-1  
Infiltration Basin

The infiltration approach to stormwater management seeks to “preserve and restore the hydrologic cycle.” An infiltration stormwater system seeks to infiltrate runoff into the soil by allowing it to flow slowly over permeable surfaces. The slow flow of runoff allows pollutants to settle into the soil where they are naturally mitigated. The reduced volume of runoff that remains takes a long time to reach the outfall, and when it empties into a natural water body or storm sewer, its pollutant load is greatly reduced.

Infiltration basins can be either open or closed. Open infiltration basins, include ponds, swales and other landscape features, are usually vegetated to maintain the porosity of the soil structure and to reduce erosion. Closed infiltration basins can be constructed under the land surface with open graded crushed stone, leaving the surface to be used for parking or other uses. Subsurface closed basins are generally more difficult to maintain and more expensive than open filtration systems, and are used primarily where high land costs demand that the land surface be reclaimed for economic use.

Infiltration systems are often designed to capture the “first flush” storm event and used in combination with a detention basin to control peak hydraulic flows. They effectively remove suspended solids, particulates, bacteria, organics and soluble metals and nutrients through the vehicle of filtration, absorption and microbial decomposition. Groundwater contamination should be considered as a potential adverse effect and should be considered where shallow groundwater is a source of drinking water. In cases where groundwater sources are deep, there is a very low chance of contamination from normal concentrations of typical urban runoff.

### Retention and Detention

Retention and detention systems differ from infiltration systems primarily in intent. Detention systems are designed to capture and retain runoff temporarily and release it to receiving waters at predevelopment flow rates. Permanent pools of water are not held between storm events. Pollutants settle out and are removed from the water column through physical processes. See Figure 3-2.

Retention systems capture runoff and retain it between storms as shown in Figure 3-3. Water held in the system is displaced by the next significant rainfall event. Pollutants settle out and are thereby removed from the water column. Because the water remains in the system for a period of time, retention systems benefit from biological and biochemical removal mechanisms provided by aquatic plants and microorganisms. See Figure 3-3.

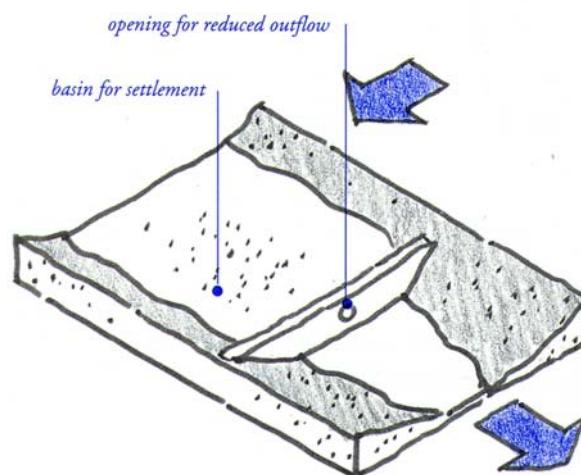
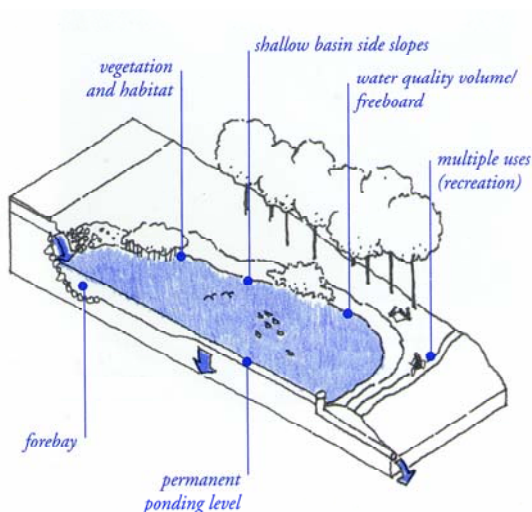

Figure 3-2  
Simple Detention System



**Figure 3-3**  
**Retention System**

Retention/detention systems may release runoff slowly enough to reduce downstream peak flows to their pre-development levels, allow fine sediments to settle, and uptake dissolved nutrients in the runoff where wetland vegetation is included.

Bioretention facilities have the added benefit of aesthetic appeal. These systems can be placed in parking lot islands, landscaped areas surrounding buildings, perimeter parking lots, and other open space sections. Placing bioretention facilities on land that city regulations require developers to devote to open space efficiently uses the land. An experienced landscape architect can choose plant species and planting materials that are easy to maintain, aesthetically pleasing, and capable of effectively reducing pollutants in runoff from the site.

Constructed wetland systems retain and release stormwater in a manner that is similar to retention or detention basins. The design mimics natural ecological functions and uses wetland vegetation to filter pollutants. The system needs a permanent water source to function properly and must be engineered to remove coarse sediment, especially construction related sediments, from entering the pond. Stormwater has the potential to negatively affect natural wetland functions and constructed wetlands can be used to buffer sensitive resources.

### Biofilters

Biofilters, also known as vegetated swales and filter strips, are vegetated slopes and channels designed and maintained to transport shallow depths of runoff slowly over vegetation. Biofilters are effective if flows are slow and depths are shallow (3% slope max.). The slow movement of runoff through the vegetation provides an opportunity for sediments and particulates to be filtered and degraded through biological activity. In most soils, the biofilter also provides an opportunity for stormwater infiltration, which further removes pollutants and reduces runoff volumes. See Figure 3-4.

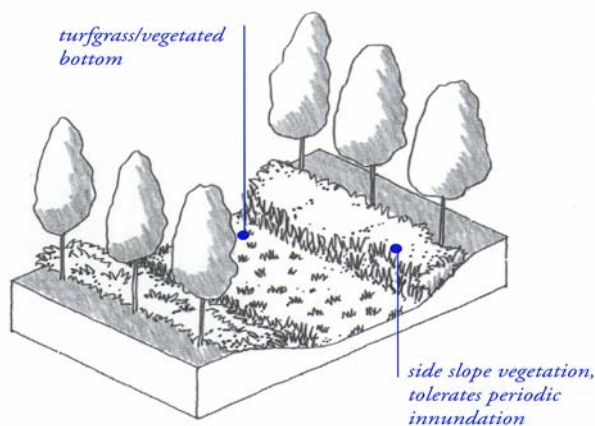

**Figure 3-4**  
**Vegetated Swale**

Swales intercept both sheet and concentrated flows and convey these flows in a concentrated, vegetation-lined channel. Grass filter strips intercept sheet runoff from the impervious network of streets, parking lots, and rooftops and divert stormwater to a uniformly graded meadow, buffer zone, or small forest. Typically, the vegetated swale and grass strip-planting palette can

comprise a wide range of possibilities from dense vegetation to turf grass. Grass strips and vegetated swales can function as pretreatment systems for water entering bioretention systems or other BMPs. If biofilters are to succeed in filtering pollutants from the water column, the planting design must consider the hydrology, soils, and maintenance requirements of the site.

Appropriate plantings not only improve water quality, they provide habitat and aesthetic benefits. Selected plant materials must be able to adapt to variable moisture regimes. Turf grass is acceptable if it can be watered in the dry season, and if it is not inundated for long periods. Species such as willows, dogwoods, sedge, rush, lilies, and bulrush tolerate varying degrees of soil moisture and can provide an attractive plant palette year round.

## **Structural Controls**

Structural controls in the context of this section include a range of measures that prevent pollutants from coming into contact with stormwater. In this context, these measures may be referred to as “structural source controls” meaning that they utilize structural features to prevent pollutant sources and stormwater from coming into contact with one another, thus reducing the opportunity for stormwater to become contaminated. Examples of structural source controls include covers, impermeable surfaces, secondary containment facilities, runoff diversion berms, and diversions to wastewater treatment plants.

### **3.2.1 Streets**

More than any other single element, street design has a powerful impact on stormwater quality. Street and other transportation-related structures typically can comprise between 60 and 70% of the total impervious coverage in urban areas and, unlike rooftops, streets are almost always directly connected to an underground stormwater system.

Recognizing that street design can be the greatest factor in development’s impact on stormwater quality, it is important that designers, municipalities and developers employ street standards that reduce impervious land coverage. Directing runoff to biofilters or swales rather than underground storm drains produces a street system that conveys stormwater efficiently while providing both water quality and aesthetic benefits.

On streets where a more urban character is desired, or where a rigid pavement edge is required, curb and gutter systems can be designed to empty into drainage swales. These swales can run parallel to the street, in the parkway between the curb and the sidewalk, or can intersect the street at cross-angles, and run between residences, depending on topography or site planning. Runoff travels along the gutter, but instead of being emptied into a catch basin and underground pipe, multiple openings in the curb direct runoff into surface swales or infiltration/detention basins.

In recent years, new street standards have been gaining acceptance that meets the access requirements of local residential streets while reducing impervious land coverage. These standards create a new class of street that is narrower and more interconnected than the current local street standard, called an “access” street. An access street is at the lowest end of the street hierarchy and is intended only to provide access to a limited number of residences.

Street design is usually mandated by local municipal standards. Officials must consider the scale of the land use as they select stormwater and water quality design solutions. Traffic volume and speeds, bicycle lane design criteria, and residential and business densities influence the willingness of decision makers to permit the narrow streets that include curbless design alternatives.

Emergency service providers often raise objections to reduced street widths. Street designs illustrated here meet national Fire Code standards for emergency access. An interconnected grid system of narrow streets also allows emergency service providers with multiple access routes to compensate for the unlikely possibility that a street may be blocked.

Many municipal street standards mandate 80 to 100% impervious land coverage in the public right-of-way, and are a principal contributor to the environmental degradation caused by development.

A street standard that allows an interconnected system of narrow access streets for residential neighborhoods has the potential to achieve several complimentary environmental and social benefits. A hierarchy of streets sized according to average daily traffic volumes yields a wide variety of benefits: improved safety from lower speeds and volumes, improved aesthetics from street trees and green parkways, reduced impervious land coverage, less heat island effect, and lower development costs. If the reduction in street width is accompanied by a drainage system that allows for infiltration of runoff, the impact of streets on stormwater quality can be greatly mitigated.

There are many examples of narrow streets, from both newly constructed and older communities, which demonstrate the impact of street design on neighborhood character and environmental quality. See Table 3-1.

<b>Table 3-1 Adopted Narrow Street Standards (Typ. Cross-Sections, two-way traffic)</b>	
City of Santa Rosa	30 ft wide with parking permitted both sides, <1000 Average Daily Traffic (ADT) 26 – 28 ft with parking permitted one side 20 ft - no parking permitted 20 ft neck downs at intersections
City of Palmdale	28 ft wide with parking permitted both sides
City of San Jose	30 ft wide with parking permitted both sides, <21 Dwelling Units (DU) 34 ft wide with parking permitted both sides, <121 DU
City of Novato	24 ft wide with parking permitted both sides, 2-4 DU 28 ft with parking permitted both sides, 5-15 DU
County of San Mateo	19 ft wide rural pavement cross-section with parking permitted on adjacent gravel shoulders

A comparison of street cross-sections is shown in Figure 3-5.

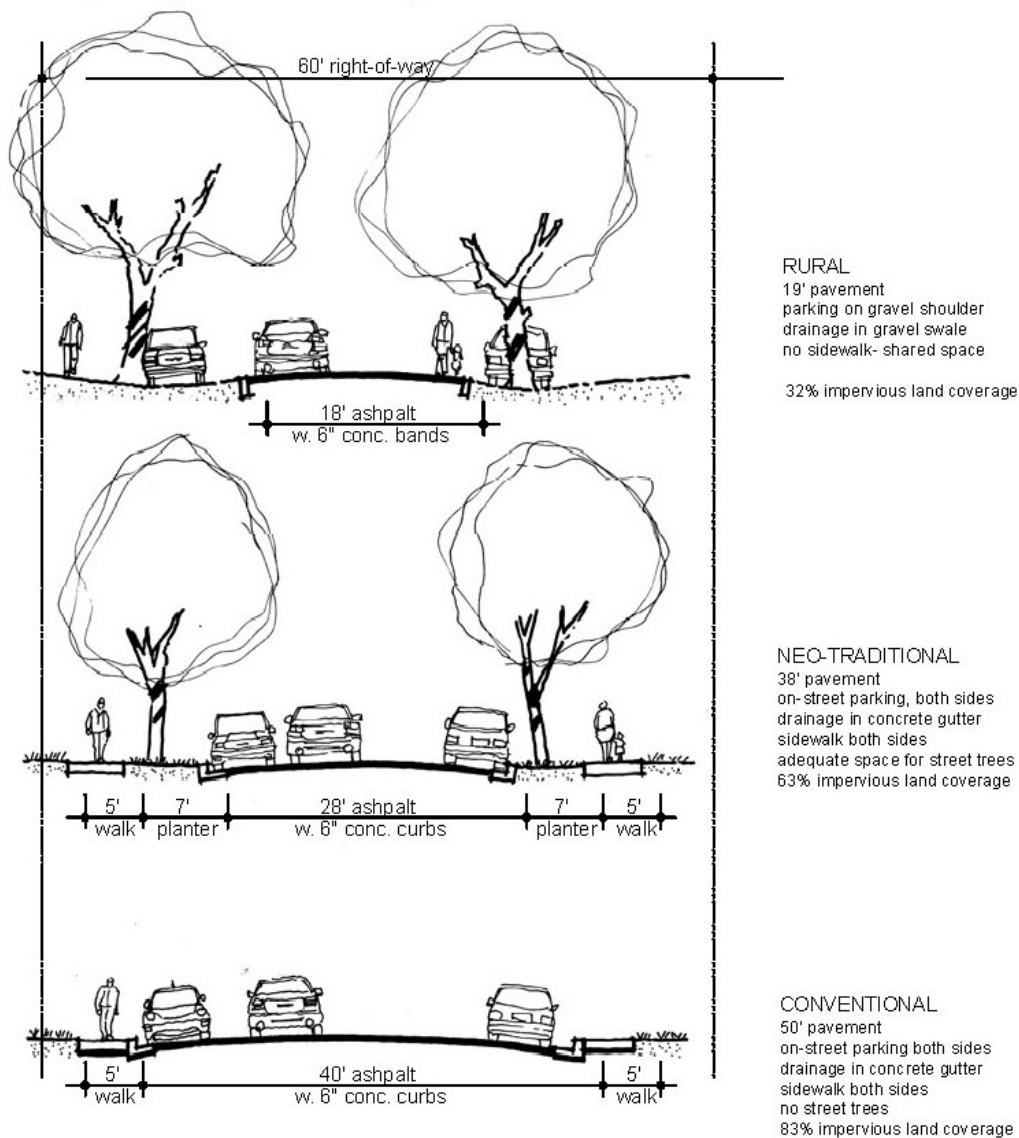

**Figure 3-5**  
 Comparison of Street Cross-Sections (two-way traffic, residential access streets)

### 3.2.2 Parking Lots

In any development, storage space for stationary vehicles can consume many acres of land area, often greater than the area covered by streets or rooftops. In a neighborhood of single-family homes, this parking area is generally located on private driveways or along the street. In higher density residential developments, parking is often consolidated in parking lots.

The space for storage of the automobile, the standard parking stall, occupies only 160 ft<sup>2</sup>, but when combined with aisles, driveways, curbs, overhang space, and median islands, a parking lot can require up to 400 ft<sup>2</sup> per vehicle, or nearly one acre per 100 cars. Since parking is usually accommodated on an asphalt or concrete surface with conventional underground storm drain systems, parking lots typically generate a great deal of DCIA.

There are many ways to both reduce the impervious land coverage of parking areas and to filter runoff before it reaches the storm drain system.

### Hybrid Parking Lot

Hybrid lots work on the principle that pavement use differs between aisles and stalls. Aisles must be designed for speeds between 10 and 20 mph, and durable enough to support the concentrated traffic of all vehicles using the lot. The stalls, on the other hand, need only be designed for the 2 or 3 mph speed of vehicles maneuvering into place. Most of the time the stalls are in use, vehicles are stationary. Hybrid lots reduce impervious surface coverage in parking areas by differentiating the paving between aisles and stalls, and combining impervious aisles with permeable stalls, as shown in Figure 3-6.

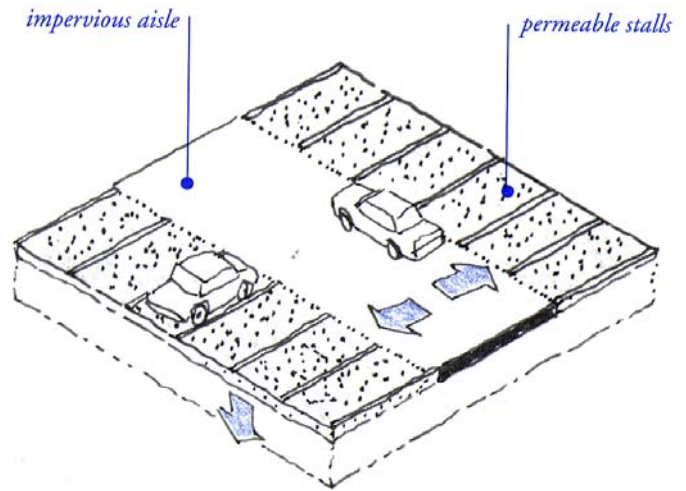

Figure 3-6  
Hybrid Parking Lot

If aisles are constructed of a more conventional, impermeable material suitable for heavier vehicle use, such as asphalt, stalls can be constructed of permeable pavement. This can reduce the overall impervious surface coverage of a typical double loaded parking lot by 60% and avoid the need for an underground drainage system.

Permeable stalls can be constructed of a number of materials including pervious concrete, unit pavers such as brick or stone spaced to expose a permeable joint and set on a permeable base, crushed aggregate, porous asphalt, turf block, and cobbles in low traffic areas. Turf blocks and permeable joints are shown in Figures 3-7 and 3-8.

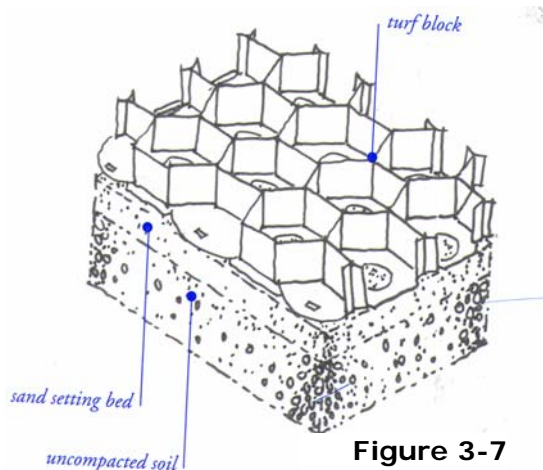

Figure 3-7  
Turf Blocks

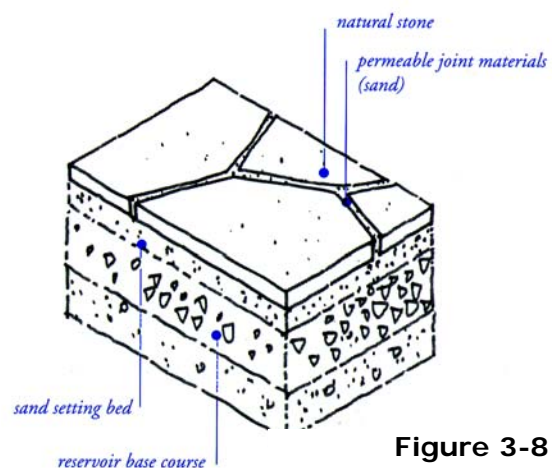

Figure 3-8  
Permeable Joints

## Parking Grove

A variation on the permeable stall design, a grid of trees and bollards can be used to delineate parking stalls and create a “parking grove.” If the bollard and tree grids are spaced approximately 19 ft apart, two vehicles can park between each row of the grid. This 9.5 ft stall spacing is slightly more generous than the standard 8.5 to 9 ft stall, and allows for the added width of the tree trunks and bollards. A benefit of this design is that the parking grove not only shades parked cars, but also presents an attractive open space when cars are absent. Examples of parking groves are shown in Figures 3-9 and 3-10.

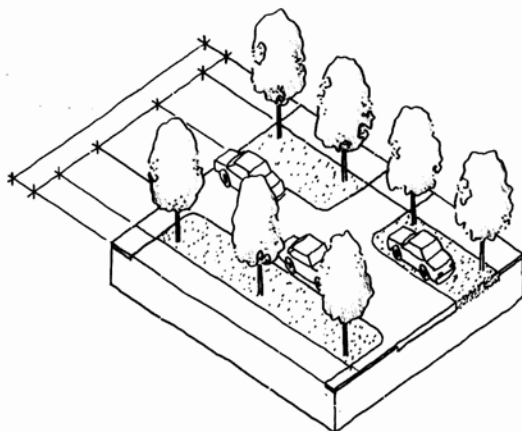

Figure 3-9  
Parking Grove

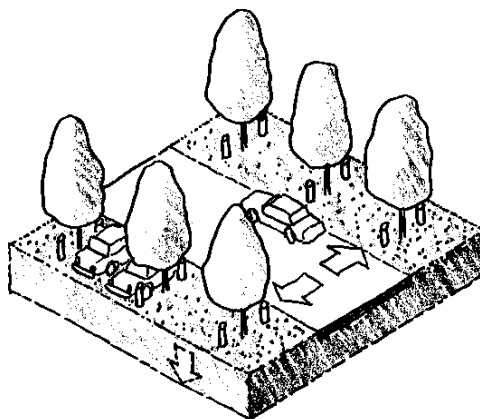

Figure 3-10  
Parking Grove

## Overflow Parking

Parking lot design is often required to accommodate peak demand, generating a high proportion of impervious land coverage of very limited usefulness. An alternative is to differentiate between regular and peak parking demands, and to construct the peak parking stalls of a different, more permeable, material. This “overflow parking” area can be made of a turf block, which appears as a green lawn when not occupied by vehicles, or crushed stone or other materials. See Figure 3-11. The same concept can be applied to areas with temporary parking needs, such as emergency access routes, or in residential applications, RV, or trailer parking.

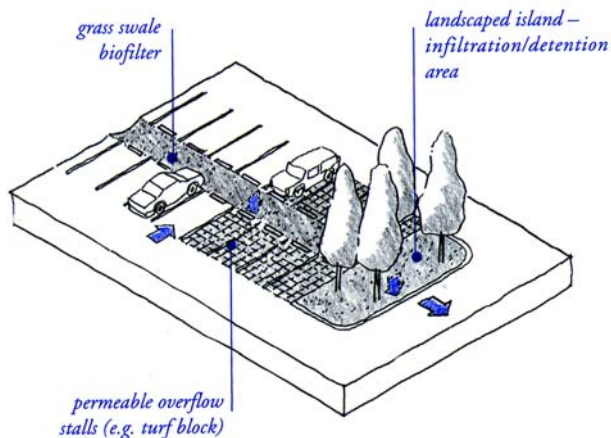
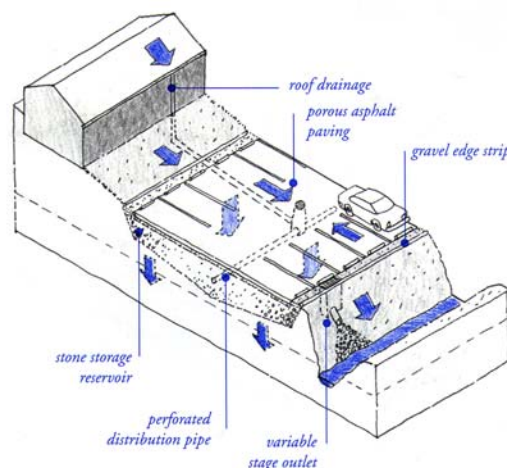

Figure 3-11  
Overflows Parking



### **Porous Pavement Recharge Bed**

In some cases, parking lots can be designed to perform more complex stormwater management functions. Constructing a stone-filled reservoir below the pavement surface and directing runoff underground by means of perforated distribution pipes can achieve subsurface stormwater storage and infiltration as shown in Figure 3-12. Subsurface infiltration basins eliminate the possibilities of mud, mosquitoes and safety hazards sometimes perceived to be associated with ephemeral surface drainage. They also can provide for storage of large volumes of runoff, and can be incorporated with roof runoff collection systems.



**Figure 3-12**  
**Porous Pavement Recharge Bed**

### **3.2.3 Driveways**

Driveways can comprise up to 40% of the total transportation network in a conventional development, with streets, turn-arounds, and sidewalks comprising the remaining 60%.

Driveway length is generally determined by garage setback requirements, and width is usually mandated by municipal codes and ordinances. If garages are setback from the street, long driveways are required, unless a rear alley system is included to provide garage access. If parking for two vehicles side by side is required, a 20 ft minimum width is required. Thus, if a 20 ft setback and a two-car-wide driveway are required, a minimum of 400 ft<sup>2</sup> of driveway will result, or 4% of a typical 10,000 ft<sup>2</sup> residential lot. If the house itself is compact, and the driveway is long, wide, and paved with an impervious material such as asphalt or concrete, it can become the largest component of impervious land coverage on the lot.

Municipalities can reduce the area dedicated to driveways by allowing for tandem parking (one vehicle in front of another on a narrow driveway). In addition, if shared driveways are permitted, then two or more garages can be accessed by a single driveway, further reducing required land area. Rear alley access to the garage can reduce driveway length, but overall impervious surface coverage may not be reduced if the alleys are paved with impervious materials and the access streets remain designed to conventional municipal standards.

Alternative solutions that work to reduce the impact of water quality problems associated with impervious land coverage on city streets also work on driveways. Sloping the driveway so that it drains onto an adjacent turf or groundcover area prevents driveways from draining directly to storm drain systems. This concept is shown in Figures 3-13 and 3-14. Use of turf-block or unit pavers on sand creates attractive, low maintenance, permeable driveways that filter stormwater. See Figure 3-15. Crushed aggregate can serve as a relatively smooth pavement with minimal maintenance as shown in Figure 3-16. Paving only under wheels (Figure 3-17) is a viable, inexpensive design if the driveway is straight between the garage and the street, and repaving temporary parking areas with permeable unit pavers such as brick or stone can significantly reduce the percentage of impervious area devoted to the driveway.

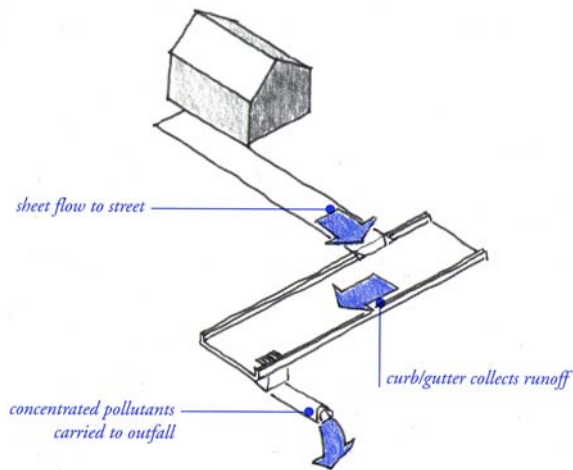

**Figure 3-13**  
**Traditional Design**  
**Drains Flow Directly to Storm Drain**

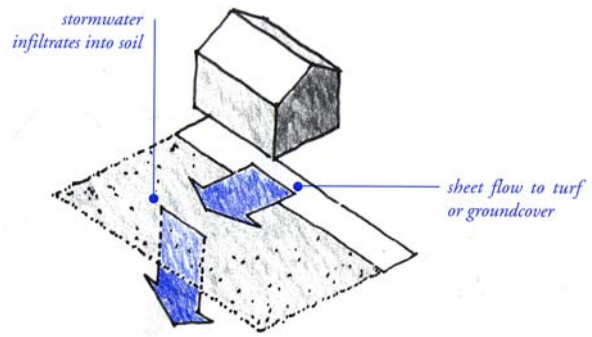

**Figure 3-14**  
**Alternative Solution**  
**Slopes Flow to Groundcover**

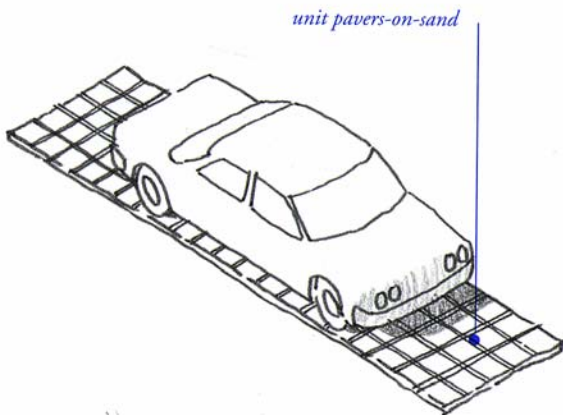

**Figure 3-15**  
**Unit Pavers**

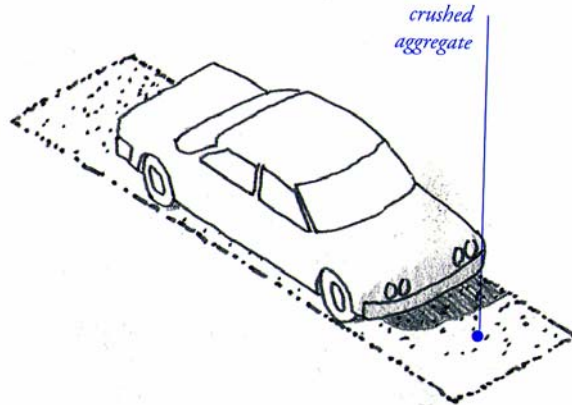

**Figure 3-16**  
**Crushed Aggregate**

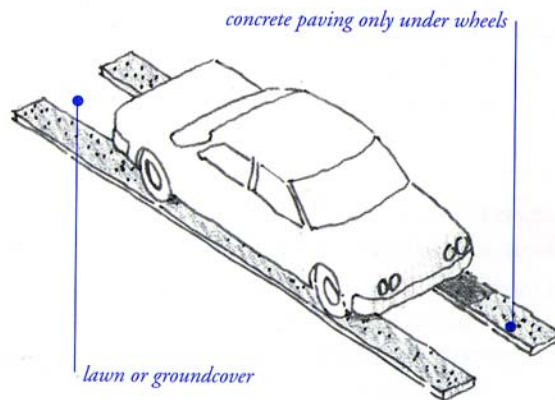

**Figure 3-17**  
**Paving Only Under Wheels**

### 3.2.4 Landscape and Open Space

In the natural landscape, most soils infiltrate a high percentage of rainwater through a complex web of organic and biological activities that build soil porosity and permeability. Roots reach into the soil and separate particles of clay, insects excavate voids in the soil mass, roots decay leaving networks of macro pores, leaves fall and form a mulch over the soil surface, and earthworms burrow and ingest organic detritus to create richer, more porous soil. These are just a few examples of the natural processes that occur within the soil.

Maintenance of a healthy soil structure through the practice of retaining or restoring native soils where possible and using soil amendments where appropriate can improve the land's ability to filter and slowly release stormwater into drainage networks. Construction practices such as decreasing soil compaction, storing topsoil on-site for use after construction, and chipping wood for mulch as it is cleared for the land can improve soil quality and help maintain healthy watersheds. Practices that reduce erosion and help retain water on-site include incorporating organic amendments into disturbed soils after construction, retaining native vegetation, and covering soil during revegetation.

Subtle changes in grading can also improve infiltration. Landscape surfaces are conventionally graded to have a slight convex slope. This causes water to run off a central high point into a surrounding drainage system, creating increased runoff. If a landscape surface is graded to have a slightly concave slope, it will hold water. The infiltration value of concave vegetated surfaces is greater in permeable soils. Soils of heavy clay or underlain with hardpan provide less infiltration value. In these cases, concave vegetated surfaces must be designed as retention/detention basins, with proper outlets or under drains to an interconnected system.

#### **Multiple Small Basins**

Biofilters, infiltration, retention/detention basins are the basic elements of a landscape designed for stormwater management. The challenge for designers is to integrate these elements creatively and attractively in the landscape – either within a conventional landscape aesthetic or by presenting a different landscape image that emphasizes the role of water and drainage.

Multiple small basins can provide a great deal of water storage and infiltration capacity. These small basins can fit into the parkway planting strip or shoulders of street rights-of-way. If connected by culverts under walks and driveways, they can create a continuous linear infiltration system. Infiltration and retention/detention basins can be placed under wood decks, in parking lot planter islands, and at roof downspouts. Outdoor patios or seating areas can be sunken a few steps, paved with a permeable pavement such as flagstone or gravel, and designed to hold a few inches of water collected from surrounding rooftops or paved areas for a few hours after a rain.

All of these are examples of small basins that can store water for a brief period, allowing it to infiltrate into the soil, slowing its release into the drainage network, and filtering pollutants. An ordinary lawn can be designed to hold a few inches of water for a few hours after a storm, attracting birds and creating a landscape of diversity. Grass/vegetated swales can be integrated with landscaping, providing an attractive, low maintenance, linear biofilter. Extended detention (dry ponds) store water during storms, holding runoff to predevelopment levels. Pollutants

settle and are removed from the water column before discharging to streams. Wet ponds serve a similar purpose and can increase property values by providing a significant aesthetic, and passive recreation opportunity.

Plant species selection is critical for proper functioning of infiltration areas. Proper selection of plant materials can improve the infiltration potential of landscape areas. Deep-rooted plants help to build soil porosity. Plant leaf-surface area helps to collect rainwater before it lands on the soil, especially in light rains, increasing the overall water-holding potential of the landscape.

A large number of plant species will survive moist soils or periodic inundation. These plants provide a wide range of choices for planted infiltration/detention basins and drainage swales. Most inundated plants have a higher survival potential on well-drained alluvial soils than on fine textured shallow soils or clays.

### **Maintenance Needs for Stormwater Systems**

All landscape treatments require maintenance. Landscapes designed to perform stormwater management functions are not necessarily more maintenance intensive than highly manicured conventional landscapes. A concave lawn requires the same mowing, fertilizing, and weeding as a convex one and often less irrigation because more rain is filtered into the underlying soil. Sometimes infiltration basins may require a different kind of maintenance than conventionally practiced.

Typical maintenance activities include periodic inspection of surface drainage systems to ensure clear flow lines, repair of eroded surfaces, adjustment or repair of drainage structures, soil cultivation or aeration, care of plant materials, replacement of dead plants, replenishment of mulch cover, irrigation, fertilizing, pruning and mowing. In addition, dead or stressed vegetation may indicate chemical dumping. Careful observation should be made of these areas to determine if such a problem exists.

Landscape maintenance can have a significant impact on soil permeability and its ability to support plant growth. Most plants concentrate the majority of their small absorbing roots in the upper 6 in. of the soil surface if a mulch or forest litter protects the surface. If the soil is exposed or bare, it can become so hot that surface roots will not grow in the upper 8 to 10 in. The common practice of removing all leaf litter and detritus with leaf blowers creates a hard-crusting soil surface of low permeability and high heat conduction. Proper mulching of the soil surface improves water retention and infiltration, while protecting the surface root zone from temperature extremes.

In addition to impacting permeability, landscape maintenance practices can have adverse effects on water quality. Because commonly used fertilizers and herbicides are a source of organic compounds, it is important to keep these practices to a minimum, and prevent overwatering.

When well maintained and designed, landscaped concave surfaces, infiltration basins, swales and bioretention areas can add aesthetic value while providing the framework for environmentally sound, comprehensive stormwater management systems.

## Street Trees

Trees improve water quality by intercepting and storing rainfall on leaves and branch surfaces, thereby reducing runoff volumes and delaying the onset of peak flows. A single street tree can have a total leaf surface area of several hundred to several thousand ft<sup>2</sup>, depending on species and size. This aboveground surface area created by trees and other plants greatly contributes to the water holding capacity of the land. They attenuate conveyance by increasing the soil's capacity to filter rainwater and reduce overland flow rates. By diminishing the impact of raindrops on un-vegetated soil, trees reduce soil erosion. Street trees also have the ability to reduce ambient temperature of stormwater runoff and absorb surface water pollutants.

When using street trees to achieve stormwater management goals, it is important to use tree species with wide canopies. Street tree design criteria should specify species expected to attain 20 to 30 ft canopies at maturity. Planter strips with adequate width and depth of soil volume are necessary to ensure tree vitality and reduce future maintenance. Structural soils also provide rooting space for large trees and can be specified along narrow planter strips and underneath sidewalks to enable continuous belowground soil and root connections.

### 3.2.5 Outdoor Work Areas

The site design and landscape details listed in previous sections are appropriate for uses where low concentrations of pollutants can be mitigated through infiltration, retention, and detention. Often in commercial and industrial sites, there are outdoor work areas in which a higher concentration of pollutants exists, and thus a higher potential of pollutants infiltrating the soil. These work areas often involve automobiles, equipment machinery, or other commercial and industrial uses, and require special consideration.

Outdoor work areas are usually isolated elements in a larger development. Infiltration and detention strategies are still appropriate for and can be applied to other areas of the site, such as parking lots, landscape areas, employee use areas, and bicycle path. It is only the outdoor work area within the development – such as the loading dock, fueling area, or equipment wash area – that requires a different drainage approach. This drainage approach is often precisely the opposite from the infiltration/detention strategy – in other words, collect and convey.

In these outdoor work areas, infiltration is discouraged and runoff is often routed directly to the sanitary sewer, not the storm drain. Because this runoff is being added to the loads normally received by the water treatment plants (publicly owned treatment works – POTWs), it raises several concerns that must be addressed in the planning and design stage. These include:

- Higher flows that could exceed the sewer system capacity
- Catastrophic spills that may cause harm to POTW operation
- A potential increase in pollutants

These concerns can be addressed at policy, management, and site planning levels.

### ***Policy***

Piping runoff and process water from outdoor work areas directly to the sanitary sewer for treatment by a downstream POTW displaces the problem of reducing stormwater pollution. Municipal stormwater programs and/or private developers can work with the local POTW to develop solutions that minimize effects on the treatment facility. It should be noted that many POTWs have traditionally prohibited the discharge of stormwater to their systems. However, these prohibitions are being reviewed in light of the benefits possible from such diversions.

### ***Management***

Commercial and industrial sites that host special activities need to implement a pollution prevention program minimizing hazardous material use and waste. For example, if restaurant grease traps are directly connected to the sanitary sewer, proper management programs can mitigate the amount of grease that escapes from the trap, clogging sewer systems and causing overflows or damage to downstream systems.

### ***Site Planning***

Outdoor work areas can be designed in particular ways to reduce their impacts on both stormwater quality and sewage treatment plants.

- Create an impermeable surface such as concrete or asphalt, or a prefabricated metal drip pan, depending on the use.
- Cover the area with a roof. This prevents rain from falling on the work area and becoming polluted runoff.
- Berm or mound around the perimeter of the area to prevent water from adjacent areas to flow on to the surface of the work area.
- Directly connect runoff. Unlike other areas, runoff from these work areas is directly connected to the sanitary sewer or other specialized containment systems. This allows the more highly concentrated pollutants from these areas to receive special treatment that removes particular constituents. Approval for this connection must be obtained from the appropriate sanitary sewer agency.
- Locate the work area away from storm drains or catch basins. If the work area is adjacent to, or directly upstream from a storm drain or landscape drainage feature (e.g., bioswales), debris or liquids from the work area can migrate into the stormwater system.
- Plan the work area to prevent run-on. This can be accomplished by raising the work area or by diverting run-on around the work area.

These design elements are general considerations for work areas. In designing any outdoor work area, evaluate local ordinances affecting the type of work area, as many local jurisdictions have specific requirements.

Some activities are common to many commercial and industrial sites. These include garbage and recycling, maintenance and storage, and loading. These activities can have a significant

negative impact on stormwater quality, and require special attention to the siting and design of the activity area.

### 3.2.6 Maintenance and Storage Areas

To reduce the possibility of contact with stormwater runoff, maintenance and storage areas can be sited away from drainage paths and waterways, and covered. Implementing a regular maintenance plan for sweeping, litter control, and spill cleanup also helps prevent stormwater pollution.

Specifying impermeable surfaces for vehicle and equipment maintenance areas will reduce the chance of pollutant infiltration. A concrete surface will usually last much longer than an asphalt one, as vehicle fluids can either dissolve asphalt or be absorbed by the asphalt and released later. See Figure 3-18.

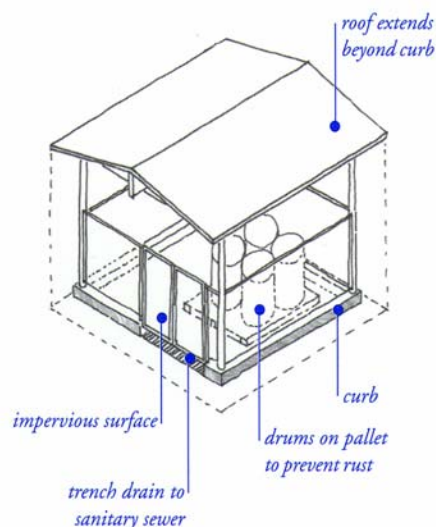

**Figure 3-18**  
Material Storage

### 3.2.7 Vehicle and Equipment Washing Areas

It is generally advisable to cover areas used for regular washing of vehicles, trucks, or equipment, surround them with a perimeter berm, and clearly mark them as a designated washing area. Sumps or drain lines can be installed to collect wash water, which may be treated for reuse or recycling, or for discharge to the sanitary sewer. The POTW may require some form of pretreatment, such as a trap, for these areas.

Fueling and maintenance activities must be isolated from the vehicle washing facilities. These activities have specific requirements, described later in this section.

Storage of bulk materials, fuels, oils, solvents, other chemicals, and process equipment should be accommodated on an impervious surface covered with a roof. To reduce the chances of corrosion, materials should not be stored directly on the ground, but supported by a wire mesh or other flooring above the impervious pavement. In uncovered areas, drums or other containers can be stored at a slight angle to prevent ponding of rainwater from rusting the lids. Liquid containers should be stored in a designated impervious area that is roofed, fenced within a berm, to prevent spills from flowing into the storm drain.

If hazardous materials are being used or stored, additional specific local, state, or federal requirements may apply.

### 3.2.8 Loading Area

Loading areas and docks can be designed with a roof or overhang, and a surrounding curb or berm. See Figure 3-19. The area should be graded to direct flow toward an inlet with a shutoff valve or dead-end sump. The sump must be designed with enough capacity to hold a spill while the valve is closed. If the sump has a valve, it must be kept in the closed position and require an

action to open it. All sumps must have a sealed bottom so they cannot infiltrate water. Contaminated accumulated waste and liquid must not be discharged to a storm drain and may be discharged to the sanitary sewer only with the POTW's permission. If the waste is not approved for discharge to the sanitary sewer, it must be conveyed to a hazardous waste (or other offsite disposal) facility, and may require pretreatment. Some specific uses have unique requirements.

### 3.2.9 Trash Storage Areas

Areas designated for trash storage can be covered to protect containers from rainfall. Where covering the trash storage area is not feasible, the area can be protected from run on using grading and berms, and connected to the sanitary sewer to prevent leaks from leaving the designated trash storage area enclosure.

### 3.2.10 Wash Areas

Areas designated for washing of floor mats, containers, exhaust filters, and similar items can be covered and enclosed to protect the area from rainfall and from overspray leaving the area. These areas can also be connected to the sanitary sewer to prevent wash waters from leaving the designated enclosures. A benefit of covering and enclosing these areas is that vectors may be reduced and aesthetics of the area improved.

### 3.2.11 Fueling Areas

In all vehicle and equipment fueling areas, plans must be developed for cleaning near fuel dispensers, emergency spill cleanup, and routine inspections to prevent leaks and ensure properly functioning equipment.

If the fueling activities are minor, fueling can be performed in a designated, covered, and bermed area that will not allow run-on of stormwater or runoff of spills.

Retail gasoline outlets and vehicle fueling areas have specific design guidelines. These are described in a Best Management Practice Guide for retail gasoline outlets developed by the California Stormwater Quality Task Force, in cooperation with major gasoline corporations. The practice guide addresses standards for existing, new, or substantially remodeled facilities. In addition, some municipal stormwater permits require RGOs to provide appropriate runoff treatment.

Fuel dispensing areas are defined as extending 6.5 ft from the corner of each fuel dispenser or the length at which the hose and nozzle assembly may be operated plus 1 ft, whichever is less. These areas must be paved with smooth impervious surfaces, such as Portland cement concrete, with a 2-4% slope to prevent ponding, and must be covered. The cover must not drain onto the work area. The rest of the site must separate the fuel dispensing area by a grade break that prevents run-on of stormwater.

Within the gas station, the outdoor trash receptacle area (garbage and recycling), and the air/water supply area must be paved and graded to prevent stormwater run-on. Trash receptacles should be covered.



# Section 4

## Source Control BMPs

### 4.1 Introduction

This section describes specific source control Best Management Practices (BMPs) to be considered for incorporation into newly developed public and private infrastructure, as well as retrofit into existing facilities to meet stormwater management objectives.

### 4.2 BMP Fact Sheets

Source control fact sheets for design are listed in Table 4-1. The fact sheets detail planning methods and concepts that should be taken into consideration by developers during project design. The fact sheets are arranged in three categories: those that have to do with landscape, irrigation, and signage considerations; those that have to do with use of particular materials; and those that have to do with design of particular areas.

### 4.3 Fact Sheet Format

A BMP fact sheet is a short document that provides information about a particular BMP. Typically, each fact sheet contains the information outlined in Figure 4-1. Supplemental information is provided if it is available. The fact sheets also contain side bar presentations with information on BMP design objectives. Completed fact sheets for each of the above activities are provided in Section 4.4.

Table 4-1 Source Control BMPs for Design	
<b>Design</b>	
SD-10	Site Design and Landscape Planning
SD-11	Roof Runoff Controls
SD-12	Efficient Irrigation
SD-13	Storm Drain System Signs
<b>Materials</b>	
SD-20	Pervious Pavements
SD-21	Alternative Building Materials
<b>Areas</b>	
SD-30	Fueling Areas
SD-31	Maintenance Bays and Docks
SD-32	Trash Enclosures
SD-33	Vehicle Washing Areas
SD-34	Outdoor Material Storage Areas
SD-35	Outdoor Work Areas
SD-36	Outdoor Processing Areas

**SDxx Example Fact Sheet**

Description of the BMP

Approach

Suitable Applications

Design Considerations

- Designing New Installations
- Redeveloping Existing Installations

Supplemental Information

- Examples
- Other Resources

**Figure 4-1**  
Example Fact Sheet

### 4.4 BMP Fact Sheets

Source Control BMP Fact Sheets for design follow. The BMP fact sheets are individually page numbered and are suitable for photocopying and inclusion in stormwater quality management plans. Fresh copies of the fact sheets can be individually downloaded from the California Stormwater BMP Handbook website at [www.cabmphandbooks.com](http://www.cabmphandbooks.com).



# Site Design & Landscape Planning SD-10



---

## Design Objectives

---

- Maximize Infiltration
  - Provide Retention
  - Slow Runoff
  - Minimize Impervious Land Coverage
  - Prohibit Dumping of Improper Materials
  - Contain Pollutants
  - Collect and Convey
- 

## Description

Each project site possesses unique topographic, hydrologic, and vegetative features, some of which are more suitable for development than others. Integrating and incorporating appropriate landscape planning methodologies into the project design is the most effective action that can be done to minimize surface and groundwater contamination from stormwater.

## Approach

Landscape planning should couple consideration of land suitability for urban uses with consideration of community goals and projected growth. Project plan designs should conserve natural areas to the extent possible, maximize natural water storage and infiltration opportunities, and protect slopes and channels.

## Suitable Applications

Appropriate applications include residential, commercial and industrial areas planned for development or redevelopment.

## Design Considerations

Design requirements for site design and landscapes planning should conform to applicable standards and specifications of agencies with jurisdiction and be consistent with applicable General Plan and Local Area Plan policies.



# SD-10 Site Design & Landscape Planning

---

## *Designing New Installations*

Begin the development of a plan for the landscape unit with attention to the following general principles:

- Formulate the plan on the basis of clearly articulated community goals. Carefully identify conflicts and choices between retaining and protecting desired resources and community growth.
- Map and assess land suitability for urban uses. Include the following landscape features in the assessment: wooded land, open unwooded land, steep slopes, erosion-prone soils, foundation suitability, soil suitability for waste disposal, aquifers, aquifer recharge areas, wetlands, floodplains, surface waters, agricultural lands, and various categories of urban land use. When appropriate, the assessment can highlight outstanding local or regional resources that the community determines should be protected (e.g., a scenic area, recreational area, threatened species habitat, farmland, fish run). Mapping and assessment should recognize not only these resources but also additional areas needed for their sustenance.

Project plan designs should conserve natural areas to the extent possible, maximize natural water storage and infiltration opportunities, and protect slopes and channels.

## *Conserve Natural Areas during Landscape Planning*

If applicable, the following items are required and must be implemented in the site layout during the subdivision design and approval process, consistent with applicable General Plan and Local Area Plan policies:

- Cluster development on least-sensitive portions of a site while leaving the remaining land in a natural undisturbed condition.
- Limit clearing and grading of native vegetation at a site to the minimum amount needed to build lots, allow access, and provide fire protection.
- Maximize trees and other vegetation at each site by planting additional vegetation, clustering tree areas, and promoting the use of native and/or drought tolerant plants.
- Promote natural vegetation by using parking lot islands and other landscaped areas.
- Preserve riparian areas and wetlands.

## *Maximize Natural Water Storage and Infiltration Opportunities Within the Landscape Unit*

- Promote the conservation of forest cover. Building on land that is already deforested affects basin hydrology to a lesser extent than converting forested land. Loss of forest cover reduces interception storage, detention in the organic forest floor layer, and water losses by evapotranspiration, resulting in large peak runoff increases and either their negative effects or the expense of countering them with structural solutions.
- Maintain natural storage reservoirs and drainage corridors, including depressions, areas of permeable soils, swales, and intermittent streams. Develop and implement policies and

# Site Design & Landscape Planning SD-10

---

regulations to discourage the clearing, filling, and channelization of these features. Utilize them in drainage networks in preference to pipes, culverts, and engineered ditches.

- Evaluating infiltration opportunities by referring to the stormwater management manual for the jurisdiction and pay particular attention to the selection criteria for avoiding groundwater contamination, poor soils, and hydrogeological conditions that cause these facilities to fail. If necessary, locate developments with large amounts of impervious surfaces or a potential to produce relatively contaminated runoff away from groundwater recharge areas.

## *Protection of Slopes and Channels during Landscape Design*

- Convey runoff safely from the tops of slopes.
- Avoid disturbing steep or unstable slopes.
- Avoid disturbing natural channels.
- Stabilize disturbed slopes as quickly as possible.
- Vegetate slopes with native or drought tolerant vegetation.
- Control and treat flows in landscaping and/or other controls prior to reaching existing natural drainage systems.
- Stabilize temporary and permanent channel crossings as quickly as possible, and ensure that increases in run-off velocity and frequency caused by the project do not erode the channel.
- Install energy dissipaters, such as riprap, at the outlets of new storm drains, culverts, conduits, or channels that enter unlined channels in accordance with applicable specifications to minimize erosion. Energy dissipaters shall be installed in such a way as to minimize impacts to receiving waters.
- Line on-site conveyance channels where appropriate, to reduce erosion caused by increased flow velocity due to increases in tributary impervious area. The first choice for linings should be grass or some other vegetative surface, since these materials not only reduce runoff velocities, but also provide water quality benefits from filtration and infiltration. If velocities in the channel are high enough to erode grass or other vegetative linings, riprap, concrete, soil cement, or geo-grid stabilization are other alternatives.
- Consider other design principles that are comparable and equally effective.

## ***Redeveloping Existing Installations***

Various jurisdictional stormwater management and mitigation plans (SUSMP, WQMP, etc.) define “redevelopment” in terms of amounts of additional impervious area, increases in gross floor area and/or exterior construction, and land disturbing activities with structural or impervious surfaces. The definition of “redevelopment” must be consulted to determine whether or not the requirements for new development apply to areas intended for redevelopment. If the definition applies, the steps outlined under “designing new installations” above should be followed.

# **SD-10 Site Design & Landscape Planning**

---

Redevelopment may present significant opportunity to add features which had not previously been implemented. Examples include incorporation of depressions, areas of permeable soils, and swales in newly redeveloped areas. While some site constraints may exist due to the status of already existing infrastructure, opportunities should not be missed to maximize infiltration, slow runoff, reduce impervious areas, disconnect directly connected impervious areas.

## **Other Resources**

A Manual for the Standard Urban Stormwater Mitigation Plan (SUSMP), Los Angeles County Department of Public Works, May 2002.

Stormwater Management Manual for Western Washington, Washington State Department of Ecology, August 2001.

Model Standard Urban Storm Water Mitigation Plan (SUSMP) for San Diego County, Port of San Diego, and Cities in San Diego County, February 14, 2002.

Model Water Quality Management Plan (WQMP) for County of Orange, Orange County Flood Control District, and the Incorporated Cities of Orange County, Draft February 2003.

Ventura Countywide Technical Guidance Manual for Stormwater Quality Control Measures, July 2002.



Rain Garden

## Design Objectives

- Maximize Infiltration
- Provide Retention
- Slow Runoff
- Minimize Impervious Land Coverage
- Prohibit Dumping of Improper Materials
- Contain Pollutants
- Collect and Convey

## Description

Various roof runoff controls are available to address stormwater that drains off rooftops. The objective is to reduce the total volume and rate of runoff from individual lots, and retain the pollutants on site that may be picked up from roofing materials and atmospheric deposition. Roof runoff controls consist of directing the roof runoff away from paved areas and mitigating flow to the storm drain system through one of several general approaches: cisterns or rain barrels; dry wells or infiltration trenches; pop-up emitters, and foundation planting. The first three approaches require the roof runoff to be contained in a gutter and downspout system. Foundation planting provides a vegetated strip under the drip line of the roof.

## Approach

Design of individual lots for single-family homes as well as lots for higher density residential and commercial structures should consider site design provisions for containing and infiltrating roof runoff or directing roof runoff to vegetative swales or buffer areas. Retained water can be reused for watering gardens, lawns, and trees. Benefits to the environment include reduced demand for potable water used for irrigation, improved stormwater quality, increased groundwater recharge, decreased runoff volume and peak flows, and decreased flooding potential.

## Suitable Applications

Appropriate applications include residential, commercial and industrial areas planned for development or redevelopment.

## Design Considerations

### *Designing New Installations*

#### *Cisterns or Rain Barrels*

One method of addressing roof runoff is to direct roof downspouts to cisterns or rain barrels. A cistern is an above ground storage vessel with either a manually operated valve or a permanently open outlet. Roof runoff is temporarily stored and then released for irrigation or infiltration between storms. The number of rain



barrels needed is a function of the rooftop area. Some low impact developers recommend that every house have at least 2 rain barrels, with a minimum storage capacity of 1000 liters. Roof barrels serve several purposes including mitigating the first flush from the roof which has a high volume, amount of contaminants, and thermal load. Several types of rain barrels are commercially available. Consideration must be given to selecting rain barrels that are vector proof and childproof. In addition, some barrels are designed with a bypass valve that filters out grit and other contaminants and routes overflow to a soak-away pit or rain garden.

If the cistern has an operable valve, the valve can be closed to store stormwater for irrigation or infiltration between storms. This system requires continual monitoring by the resident or grounds crews, but provides greater flexibility in water storage and metering. If a cistern is provided with an operable valve and water is stored inside for long periods, the cistern must be covered to prevent mosquitoes from breeding.

A cistern system with a permanently open outlet can also provide for metering stormwater runoff. If the cistern outlet is significantly smaller than the size of the downspout inlet (say  $\frac{1}{4}$  to  $\frac{1}{2}$  inch diameter), runoff will build up inside the cistern during storms, and will empty out slowly after peak intensities subside. This is a feasible way to mitigate the peak flow increases caused by rooftop impervious land coverage, especially for the frequent, small storms.

#### *Dry wells and Infiltration Trenches*

Roof downspouts can be directed to dry wells or infiltration trenches. A dry well is constructed by excavating a hole in the ground and filling it with an open graded aggregate, and allowing the water to fill the dry well and infiltrate after the storm event. An underground connection from the downspout conveys water into the dry well, allowing it to be stored in the voids. To minimize sedimentation from lateral soil movement, the sides and top of the stone storage matrix can be wrapped in a permeable filter fabric, though the bottom may remain open. A perforated observation pipe can be inserted vertically into the dry well to allow for inspection and maintenance.

In practice, dry wells receiving runoff from single roof downspouts have been successful over long periods because they contain very little sediment. They must be sized according to the amount of rooftop runoff received, but are typically 4 to 5 feet square, and 2 to 3 feet deep, with a minimum of 1-foot soil cover over the top (maximum depth of 10 feet).

To protect the foundation, dry wells must be set away from the building at least 10 feet. They must be installed in solids that accommodate infiltration. In poorly drained soils, dry wells have very limited feasibility.

Infiltration trenches function in a similar manner and would be particularly effective for larger roof areas. An infiltration trench is a long, narrow, rock-filled trench with no outlet that receives stormwater runoff. These are described under Treatment Controls.

#### *Pop-up Drainage Emitter*

Roof downspouts can be directed to an underground pipe that daylights some distance from the building foundation, releasing the roof runoff through a pop-up emitter. Similar to a pop-up irrigation head, the emitter only opens when there is flow from the roof. The emitter remains flush to the ground during dry periods, for ease of lawn or landscape maintenance.



## *Foundation Planting*

Landscape planting can be provided around the base to allow increased opportunities for stormwater infiltration and protect the soil from erosion caused by concentrated sheet flow coming off the roof. Foundation plantings can reduce the physical impact of water on the soil and provide a subsurface matrix of roots that encourage infiltration. These plantings must be sturdy enough to tolerate the heavy runoff sheet flows, and periodic soil saturation.

## ***Redeveloping Existing Installations***

Various jurisdictional stormwater management and mitigation plans (SUSMP, WQMP, etc.) define “redevelopment” in terms of amounts of additional impervious area, increases in gross floor area and/or exterior construction, and land disturbing activities with structural or impervious surfaces. The definition of “redevelopment” must be consulted to determine whether or not the requirements for new development apply to areas intended for redevelopment. If the definition applies, the steps outlined under “designing new installations” above should be followed.

## **Supplemental Information**

### ***Examples***

- City of Ottawa’s Water Links Surface –Water Quality Protection Program
- City of Toronto Downspout Disconnection Program
- City of Boston, MA, Rain Barrel Demonstration Program

### **Other Resources**

Hager, Marty Catherine, Stormwater, “Low-Impact Development”, January/February 2003.  
[www.stormh2o.com](http://www.stormh2o.com)

Low Impact Urban Design Tools, Low Impact Development Design Center, Beltsville, MD.  
[www.lid-stormwater.net](http://www.lid-stormwater.net)

Start at the Source, Bay Area Stormwater Management Agencies Association, 1999 Edition





## Design Objectives

- Maximize Infiltration
- Provide Retention
- Slow Runoff
- Minimize Impervious Land Coverage
- Prohibit Dumping of Improper Materials
- Contain Pollutants
- Collect and Convey

## Description

Irrigation water provided to landscaped areas may result in excess irrigation water being conveyed into stormwater drainage systems.

## Approach

Project plan designs for development and redevelopment should include application methods of irrigation water that minimize runoff of excess irrigation water into the stormwater conveyance system.

## Suitable Applications

Appropriate applications include residential, commercial and industrial areas planned for development or redevelopment. (Detached residential single-family homes are typically excluded from this requirement.)

## Design Considerations

### *Designing New Installations*

The following methods to reduce excessive irrigation runoff should be considered, and incorporated and implemented where determined applicable and feasible by the Permittee:

- Employ rain-triggered shutoff devices to prevent irrigation after precipitation.
- Design irrigation systems to each landscape area's specific water requirements.
- Include design featuring flow reducers or shutoff valves triggered by a pressure drop to control water loss in the event of broken sprinkler heads or lines.
- Implement landscape plans consistent with County or City water conservation resolutions, which may include provision of water sensors, programmable irrigation times (for short cycles), etc.



- Design timing and application methods of irrigation water to minimize the runoff of excess irrigation water into the storm water drainage system.
- Group plants with similar water requirements in order to reduce excess irrigation runoff and promote surface filtration. Choose plants with low irrigation requirements (for example, native or drought tolerant species). Consider design features such as:
  - Using mulches (such as wood chips or bar) in planter areas without ground cover to minimize sediment in runoff
  - Installing appropriate plant materials for the location, in accordance with amount of sunlight and climate, and use native plant materials where possible and/or as recommended by the landscape architect
  - Leaving a vegetative barrier along the property boundary and interior watercourses, to act as a pollutant filter, where appropriate and feasible
  - Choosing plants that minimize or eliminate the use of fertilizer or pesticides to sustain growth
- Employ other comparable, equally effective methods to reduce irrigation water runoff.

### ***Redeveloping Existing Installations***

Various jurisdictional stormwater management and mitigation plans (SUSMP, WQMP, etc.) define “redevelopment” in terms of amounts of additional impervious area, increases in gross floor area and/or exterior construction, and land disturbing activities with structural or impervious surfaces. The definition of “redevelopment” must be consulted to determine whether or not the requirements for new development apply to areas intended for redevelopment. If the definition applies, the steps outlined under “designing new installations” above should be followed.

### **Other Resources**

A Manual for the Standard Urban Stormwater Mitigation Plan (SUSMP), Los Angeles County Department of Public Works, May 2002.

Model Standard Urban Storm Water Mitigation Plan (SUSMP) for San Diego County, Port of San Diego, and Cities in San Diego County, February 14, 2002.

Model Water Quality Management Plan (WQMP) for County of Orange, Orange County Flood Control District, and the Incorporated Cities of Orange County, Draft February 2003.

Ventura Countywide Technical Guidance Manual for Stormwater Quality Control Measures, July 2002.



## Design Objectives

- Maximize Infiltration
- Provide Retention
- Slow Runoff
- Minimize Impervious Land Coverage
- Prohibit Dumping of Improper Materials
- Contain Pollutants
- Collect and Convey

## Description

Waste materials dumped into storm drain inlets can have severe impacts on receiving and ground waters. Posting notices regarding discharge prohibitions at storm drain inlets can prevent waste dumping. Storm drain signs and stencils are highly visible source controls that are typically placed directly adjacent to storm drain inlets.

## Approach

The stencil or affixed sign contains a brief statement that prohibits dumping of improper materials into the urban runoff conveyance system. Storm drain messages have become a popular method of alerting the public about the effects of and the prohibitions against waste disposal.

## Suitable Applications

Stencils and signs alert the public to the destination of pollutants discharged to the storm drain. Signs are appropriate in residential, commercial, and industrial areas, as well as any other area where contributions or dumping to storm drains is likely.

## Design Considerations

Storm drain message markers or placards are recommended at all storm drain inlets within the boundary of a development project. The marker should be placed in clear sight facing toward anyone approaching the inlet from either side. All storm drain inlet locations should be identified on the development site map.

## *Designing New Installations*

The following methods should be considered for inclusion in the project design and show on project plans:

- Provide stenciling or labeling of all storm drain inlets and catch basins, constructed or modified, within the project area with prohibitive language. Examples include “NO DUMPING



– DRAINS TO OCEAN” and/or other graphical icons to discourage illegal dumping.

- Post signs with prohibitive language and/or graphical icons, which prohibit illegal dumping at public access points along channels and creeks within the project area.

Note - Some local agencies have approved specific signage and/or storm drain message placards for use. Consult local agency stormwater staff to determine specific requirements for placard types and methods of application.

### ***Redeveloping Existing Installations***

Various jurisdictional stormwater management and mitigation plans (SUSMP, WQMP, etc.) define “redevelopment” in terms of amounts of additional impervious area, increases in gross floor area and/or exterior construction, and land disturbing activities with structural or impervious surfaces. If the project meets the definition of “redevelopment”, then the requirements stated under “designing new installations” above should be included in all project design plans.

### **Additional Information**

#### ***Maintenance Considerations***

- Legibility of markers and signs should be maintained. If required by the agency with jurisdiction over the project, the owner/operator or homeowner’s association should enter into a maintenance agreement with the agency or record a deed restriction upon the property title to maintain the legibility of placards or signs.

#### ***Placement***

- Signage on top of curbs tends to weather and fade.
- Signage on face of curbs tends to be worn by contact with vehicle tires and sweeper brooms.

### **Supplemental Information**

#### ***Examples***

- Most MS4 programs have storm drain signage programs. Some MS4 programs will provide stencils, or arrange for volunteers to stencil storm drains as part of their outreach program.

### **Other Resources**

A Manual for the Standard Urban Stormwater Mitigation Plan (SUSMP), Los Angeles County Department of Public Works, May 2002.

Model Standard Urban Storm Water Mitigation Plan (SUSMP) for San Diego County, Port of San Diego, and Cities in San Diego County, February 14, 2002.

Model Water Quality Management Plan (WQMP) for County of Orange, Orange County Flood Control District, and the Incorporated Cities of Orange County, Draft February 2003.

Ventura Countywide Technical Guidance Manual for Stormwater Quality Control Measures, July 2002.



## Design Objectives

- Maximize Infiltration
- Provide Retention
- Slow Runoff
- Minimize Impervious Land Coverage
- Prohibit Dumping of Improper Materials
- Contain Pollutants
- Collect and Convey

## Description

Pervious paving is used for light vehicle loading in parking areas. The term describes a system comprising a load-bearing, durable surface together with an underlying layered structure that temporarily stores water prior to infiltration or drainage to a controlled outlet. The surface can itself be porous such that water infiltrates across the entire surface of the material (e.g., grass and gravel surfaces, porous concrete and porous asphalt), or can be built up of impermeable blocks separated by spaces and joints, through which the water can drain. This latter system is termed 'permeable' paving. Advantages of pervious pavements is that they reduce runoff volume while providing treatment, and are unobtrusive resulting in a high level of acceptability.

## Approach

Attenuation of flow is provided by the storage within the underlying structure or sub base, together with appropriate flow controls. An underlying geotextile may permit groundwater recharge, thus contributing to the restoration of the natural water cycle. Alternatively, where infiltration is inappropriate (e.g., if the groundwater vulnerability is high, or the soil type is unsuitable), the surface can be constructed above an impermeable membrane. The system offers a valuable solution for drainage of spatially constrained urban areas.

Significant attenuation and improvement in water quality can be achieved by permeable pavements, whichever method is used. The surface and subsurface infrastructure can remove both the soluble and fine particulate pollutants that occur within urban runoff. Roof water can be piped into the storage area directly, adding areas from which the flow can be attenuated. Also, within lined systems, there is the opportunity for stored runoff to be piped out for reuse.

## Suitable Applications

Residential, commercial and industrial applications are possible. The use of permeable pavement may be restricted in cold regions, arid regions or regions with high wind erosion. There are some specific disadvantages associated with permeable pavement, which are as follows:



- Permeable pavement can become clogged if improperly installed or maintained. However, this is countered by the ease with which small areas of paving can be cleaned or replaced when blocked or damaged.
- Their application should be limited to highways with low traffic volumes, axle loads and speeds (less than 30 mph limit), car parking areas and other lightly trafficked or non-trafficked areas. Permeable surfaces are currently not considered suitable for adoptable roads due to the risks associated with failure on high speed roads, the safety implications of ponding, and disruption arising from reconstruction.
- When using un-lined, infiltration systems, there is some risk of contaminating groundwater, depending on soil conditions and aquifer susceptibility. However, this risk is likely to be small because the areas drained tend to have inherently low pollutant loadings.
- The use of permeable pavement is restricted to gentle slopes.
- Porous block paving has a higher risk of abrasion and damage than solid blocks.

### Design Considerations

#### *Designing New Installations*

If the grades, subsoils, drainage characteristics, and groundwater conditions are suitable, permeable paving may be substituted for conventional pavement on parking areas, cul de sacs and other areas with light traffic. Slopes should be flat or very gentle. Scottish experience has shown that permeable paving systems can be installed in a wide range of ground conditions, and the flow attenuation performance is excellent even when the systems are lined.

The suitability of a pervious system at a particular pavement site will, however, depend on the loading criteria required of the pavement.

Where the system is to be used for infiltrating drainage waters into the ground, the vulnerability of local groundwater sources to pollution from the site should be low, and the seasonal high water table should be at least 4 feet below the surface.

Ideally, the pervious surface should be horizontal in order to intercept local rainfall at source. On sloping sites, pervious surfaces may be terraced to accommodate differences in levels.

#### *Design Guidelines*

The design of each layer of the pavement must be determined by the likely traffic loadings and their required operational life. To provide satisfactory performance, the following criteria should be considered:

- The subgrade should be able to sustain traffic loading without excessive deformation.
- The granular capping and sub-base layers should give sufficient load-bearing to provide an adequate construction platform and base for the overlying pavement layers.
- The pavement materials should not crack or suffer excessive rutting under the influence of traffic. This is controlled by the horizontal tensile stress at the base of these layers.



There is no current structural design method specifically for pervious pavements. Allowances should be considered the following factors in the design and specification of materials:

- Pervious pavements use materials with high permeability and void space. All the current UK pavement design methods are based on the use of conventional materials that are dense and relatively impermeable. The stiffness of the materials must therefore be assessed.
- Water is present within the construction and can soften and weaken materials, and this must be allowed for.
- Existing design methods assume full friction between layers. Any geotextiles or geomembranes must be carefully specified to minimize loss of friction between layers.
- Porous asphalt loses adhesion and becomes brittle as air passes through the voids. Its durability is therefore lower than conventional materials.

The single sized grading of materials used means that care should be taken to ensure that loss of finer particles between unbound layers does not occur.

Positioning a geotextile near the surface of the pervious construction should enable pollutants to be trapped and retained close to the surface of the construction. This has both advantages and disadvantages. The main disadvantage is that the filtering of sediments and their associated pollutants at this level may hamper percolation of waters and can eventually lead to surface ponding. One advantage is that even if eventual maintenance is required to reinstate infiltration, only a limited amount of the construction needs to be disturbed, since the sub-base below the geotextile is protected. In addition, the pollutant concentration at a high level in the structure allows for its release over time. It is slowly transported in the stormwater to lower levels where chemical and biological processes may be operating to retain or degrade pollutants.

The design should ensure that sufficient void space exists for the storage of sediments to limit the period between remedial works.

- Pervious pavements require a single size grading to give open voids. The choice of materials is therefore a compromise between stiffness, permeability and storage capacity.
- Because the sub-base and capping will be in contact with water for a large part of the time, the strength and durability of the aggregate particles when saturated and subjected to wetting and drying should be assessed.
- A uniformly graded single size material cannot be compacted and is liable to move when construction traffic passes over it. This effect can be reduced by the use of angular crushed rock material with a high surface friction.

In pollution control terms, these layers represent the site of long term chemical and biological pollutant retention and degradation processes. The construction materials should be selected, in addition to their structural strength properties, for their ability to sustain such processes. In general, this means that materials should create neutral or slightly alkaline conditions and they should provide favorable sites for colonization by microbial populations.

*Construction/Inspection Considerations*

- Permeable surfaces can be laid without cross-falls or longitudinal gradients.
- The blocks should be laid level
- They should not be used for storage of site materials, unless the surface is well protected from deposition of silt and other spillages.
- The pavement should be constructed in a single operation, as one of the last items to be built, on a development site. Landscape development should be completed before pavement construction to avoid contamination by silt or soil from this source.
- Surfaces draining to the pavement should be stabilized before construction of the pavement.
- Inappropriate construction equipment should be kept away from the pavement to prevent damage to the surface, sub-base or sub-grade.

*Maintenance Requirements*

The maintenance requirements of a pervious surface should be reviewed at the time of design and should be clearly specified. Maintenance is required to prevent clogging of the pervious surface. The factors to be considered when defining maintenance requirements must include:

- Type of use
- Ownership
- Level of trafficking
- The local environment and any contributing catchments

Studies in the UK have shown satisfactory operation of porous pavement systems without maintenance for over 10 years and recent work by Imbe et al. at 9th ICUD, Portland, 2002 describes systems operating for over 20 years without maintenance. However, performance under such regimes could not be guaranteed, Table 1 shows typical recommended maintenance regimes:

<b>Activity</b>	<b>Schedule</b>
<ul style="list-style-type: none"> <li>■ Minimize use of salt or grit for de-icing</li> <li>■ Keep landscaped areas well maintained</li> <li>■ Prevent soil being washed onto pavement</li> </ul>	Ongoing
<ul style="list-style-type: none"> <li>■ Vacuum clean surface using commercially available sweeping machines at the following times:                             <ul style="list-style-type: none"> <li>- End of winter (April)</li> <li>- Mid-summer (July / August)</li> <li>- After Autumn leaf-fall (November)</li> </ul> </li> </ul>	2/3 x per year
<ul style="list-style-type: none"> <li>■ Inspect outlets</li> </ul>	Annual
<ul style="list-style-type: none"> <li>■ If routine cleaning does not restore infiltration rates, then reconstruction of part of the whole of a pervious surface may be required.</li> <li>■ The surface area affected by hydraulic failure should be lifted for inspection of the internal materials to identify the location and extent of the blockage.</li> <li>■ Surface materials should be lifted and replaced after brush cleaning. Geotextiles may need complete replacement.</li> <li>■ Sub-surface layers may need cleaning and replacing.</li> <li>■ Removed silts may need to be disposed of as controlled waste.</li> </ul>	As needed (infrequent) Maximum 15-20 years

Permeable pavements are up to 25 % cheaper (or at least no more expensive than the traditional forms of pavement construction), when all construction and drainage costs are taken into account. (Accepting that the porous asphalt itself is a more expensive surfacing, the extra cost of which is offset by the savings in underground pipework etc.) (Niemczynowicz, et al., 1987)

Table 1 gives US cost estimates for capital and maintenance costs of porous pavements (Landphair et al., 2000)

### ***Redeveloping Existing Installations***

Various jurisdictional stormwater management and mitigation plans (SUSMP, WQMP, etc.) define “redevelopment” in terms of amounts of additional impervious area, increases in gross floor area and/or exterior construction, and land disturbing activities with structural or impervious surfaces. The definition of “redevelopment” must be consulted to determine whether or not the requirements for new development apply to areas intended for redevelopment. If the definition applies, the steps outlined under “designing new installations” above should be followed.

## **Additional Information**

### *Cost Considerations*

Permeable pavements are up to 25 % cheaper (or at least no more expensive than the traditional forms of pavement construction), when all construction and drainage costs are taken into account. (Accepting that the porous asphalt itself is a more expensive surfacing, the extra cost of which is offset by the savings in underground pipework etc.) (Niemczynowicz, et al., 1987)

Table 2 gives US cost estimates for capital and maintenance costs of porous pavements (Landphair et al., 2000)

Table 2 Engineer's Estimate for Porous Pavement

Porous Pavement													
Item	Units	Price	Cycles/ Year	Quant. 1 Acre WS	Total	Quant. 2 Acre WS	Total	Quant. 3 Acre WS	Total	Quant. 4 Acre WS	Total	Quant. 5 Acre WS	Total
Grading	SY	\$2.00		604	\$1,208	1209	\$2,418	1812	\$3,624	2419	\$4,838	3020	\$6,040
Paving	SY	\$19.00		212	\$4,028	424	\$8,056	636	\$12,084	848	\$16,112	1060	\$20,140
Excavation	CY	\$3.60		201	\$724	403	\$1,451	604	\$2,174	806	\$2,902	1008	\$3,629
Filter Fabric	SY	\$1.15		700	\$805	1400	\$1,610	2000	\$2,300	2800	\$3,220	3600	\$4,140
Stone Fill	CY	\$16.00		201	\$3,216	403	\$6,448	604	\$9,664	806	\$12,896	1008	\$16,128
Sand	CY	\$7.00		100	\$700	200	\$1,400	300	\$2,100	400	\$2,800	500	\$3,500
Sight Well	EA	\$300.00		2	\$600	3	\$900	4	\$1,200	7	\$2,100	7	\$2,100
Seeding	LF	\$0.05		644	\$32	1288	\$64	1932	\$97	2576	\$129	3220	\$161
Check Dam	CY	\$35.00		0	\$0	0	\$0	0	\$0	0	\$0	0	\$0
<b>Total Construction Costs</b>					<b>\$10,105</b>		<b>\$19,929</b>		<b>\$29,619</b>		<b>\$40,158</b>		<b>\$49,798</b>
<b>Construction Costs Amortized for 20 Years</b>					<b>\$505</b>		<b>\$996</b>		<b>\$1,481</b>		<b>\$2,008</b>		<b>\$2,490</b>
Annual Maintenance Expense													
Item	Units	Price	Cycles/ Year	Quant. 1 Acre WS	Total	Quant. 2 Acre WS	Total	Quant. 3 Acre WS	Total	Quant. 4 Acre WS	Total	Quant. 5 Acre WS	Total
Sweeping	AC	\$250.00	6	1	\$1,500	2	\$3,000	3	\$4,500	4	\$6,000	5	\$7,500
Washing	AC	\$250.00	6	1	\$1,500	2	\$3,000	3	\$4,500	4	\$6,000	5	\$7,500
Inspection	MH	\$20.00	5	5	\$100	5	\$100	5	\$100	5	\$100	5	\$100
Deep Clean	AC	\$450.00	0.5	1	\$225	2	\$450	3	\$675	3.9	\$878	5	\$1,125
<b>Total Annual Maintenance Expense</b>					<b>\$3,960</b>		<b>\$7,792</b>		<b>\$11,651</b>		<b>\$15,483</b>		<b>\$19,370</b>

**Other Resources**

Abbott C.L. and Comino-Mateos L. 2001. *In situ performance monitoring of an infiltration drainage system and field testing of current design procedures*. Journal CIWEM, 15(3), pp.198-202.

Construction Industry Research and Information Association (CIRIA). 2002. *Source Control using Constructed Pervious Surfaces C582*, London, SW1P 3AU.

Construction Industry Research and Information Association (CIRIA). 2000. *Sustainable urban drainage systems - design manual for Scotland and Northern Ireland Report C521*, London, SW1P 3AU.

Construction Industry Research and Information Association (CIRIA). 2000 C522 *Sustainable urban drainage systems - design manual for England and Wales*, London, SW1P 3AU.

Construction Industry Research and Information Association (CIRIA). *RP448 Manual of good practice for the design, construction and maintenance of infiltration drainage systems for stormwater runoff control and disposal*, London, SW1P 3AU.

Dierkes C., Kuhlmann L., Kandasamy J. & Angelis G. Pollution Retention Capability and Maintenance of Permeable Pavements. *Proc 9<sup>th</sup> International Conference on Urban Drainage, Portland Oregon, September 2002*.

Hart P (2002) Permeable Paving as a Stormwater Source Control System. *Paper presented at Scottish Hydraulics Study Group 14<sup>th</sup> Annual seminar, SUDS. 22 March 2002, Glasgow*.

Kobayashi M., 1999. Stormwater runoff control in Nagoya City. *Proc. 8 th Int. Conf. on Urban Storm Drainage, Sydney, Australia, pp.825-833*.

Landphair, H., McFalls, J., Thompson, D., 2000, Design Methods, Selection, and Cost Effectiveness of Stormwater Quality Structures, Texas Transportation Institute Research Report 1837-1, College Station, Texas.

Legret M, Colandini V, Effects of a porous pavement with reservoir structure on runoff water: water quality and the fate of heavy metals. *Laboratoire Central Des Ponts et Chaussées*

Macdonald K. & Jefferies C. Performance Comparison of Porous Paved and Traditional Car Parks. *Proc. First National Conference on Sustainable Drainage Systems, Coventry June 2001*.

Niemczynowicz J, Hogland W, 1987: Test of porous pavements performed in Lund, Sweden, in *Topics in Drainage Hydraulics and Hydrology*. BC. Yen (Ed.), pub. Int. Assoc. For Hydraulic Research, pp 19-80.

Pratt C.J. SUSTAINABLE URBAN DRAINAGE – A Review of published material on the performance of various SUDS devices prepared for the UK Environment Agency. *Coventry University, UK December 2001*.

Pratt C.J., 1995. Infiltration drainage – case studies of UK practice. *Project Report*

22, Construction Industry Research and Information Association, London, SW1P 3AU; also known as National Rivers Authority R & D Note 485

Pratt, C. J., 1990. Permeable Pavements for Stormwater Quality Enhancement. In: *Urban Stormwater Quality Enhancement - Source Control, retrofitting and combined sewer technology*, Ed. H.C. Torno, ASCE, ISBN 087262 7594, pp. 131-155

Raimbault G., 1997 French Developments in Reservoir Structures Sustainable water resources I the 21<sup>st</sup> century. Malmo Sweden

Schlüter W. & Jefferies C. Monitoring the outflow from a *Porous Car Park Proc. First National Conference on Sustainable Drainage Systems, Coventry June 2001.*

Wild, T.C., Jefferies, C., and D'Arcy, B.J. SUDS in Scotland – the Scottish SUDS database Report No SR(02)09 *Scotland and Northern Ireland Forum for Environmental Research, Edinburgh.* In preparation August 2002.

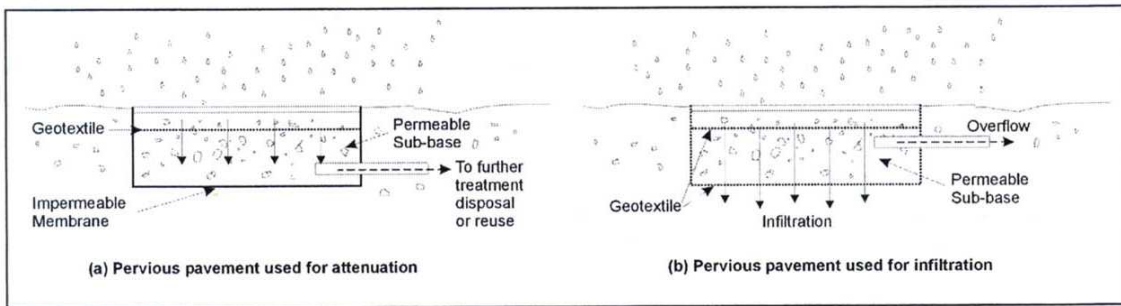

Schematics of a Pervious Pavement System





## Design Objectives

- Maximize Infiltration
- Provide Retention
- Source Control
- Minimize Impervious Land Coverage
- Prohibit Dumping of Improper Materials
- Contain Pollutant
- Collect and Convey

## Description

Alternative building materials are selected instead of conventional materials for new construction and renovation. These materials reduce potential sources of pollutants in stormwater runoff by eliminating compounds that can leach into runoff, reducing the need for pesticide application, reducing the need for painting and other maintenance, or by reducing the volume of runoff.

## Approach

Alternative building materials are available for use as lumber for decking, roofing materials, home siding, and paving for driveways, decks, and sidewalks.

## Suitable Applications

Appropriate applications include residential, commercial and industrial areas planned for development or redevelopment.

## Design Considerations

### ***Designing New Installations***

#### *Decking*

One of the most common materials for construction of decks and other outdoor construction has traditionally been pressure treated wood, which is now being phased out. The standard treatment is called CCA, for chromated copper arsenate. The key ingredients are arsenic (which kills termites, carpenter ants and other insects), copper (which kills the fungi that cause wood to rot) and chromium (which reacts with the other ingredients to bind them to the wood). The amount of arsenic is far from trivial. A deck just 8 feet x 10 feet contains more than 1 1/3 pounds of this highly potent poison. Replacement materials include a new type of pressure treated wood, plastic and composite lumber.



There are currently over 20 products in the market consisting of plastic or plastic-wood composites. Plastic lumber is made from 100% recycled plastic, # 2 HDPE and polyethylene plastic milk jugs and soap bottles. Plastic-wood composites are a combination of plastic and wood fibers or sawdust. These materials are a long lasting exterior weather, insect, and chemical resistant wood lumber replacement for non structural applications. Use it for decks, docks, raised garden beds and planter boxes, pallets, hand railings, outdoor furniture, animal pens, boat decks, etc.

New pressure treated wood uses a much safer recipe, ACQ, which stands for ammoniacal copper quaternary. It contains no arsenic and no chromium. Yet the American Wood Preservers Association has found it to be just as effective as the standard formula. ACQ is common in Japan and Europe.

### *Roofing*

Several studies have indicated that metal used as roofing material, flashing, or gutters can leach metals into the environment. The leaching occurs because rainfall is slightly acidic and slowly dissolved the exposed metals. Common traditional applications include copper sheathing and galvanized (zinc) gutters.

Coated metal products are available for both roofing and gutter applications. These products eliminate contact of bare metal with rainfall, eliminating one source of metals in runoff. There are also roofing materials made of recycled rubber and plastic that resemble traditional materials.

A less traditional approach is the use of green roofs. These roofs are not just green, they're alive. Planted with grasses and succulents, low- profile green roofs reduce the urban heat island effect, stormwater runoff, and cooling costs, while providing wildlife habitat and a connection to nature for building occupants. These roofs are widely used on industrial facilities in Europe and have been established as experimental installations in several locations in the US, including Portland, Oregon. Their feasibility is questionable in areas of California with prolonged, dry, hot weather.

### *Paved Areas*

Traditionally, concrete is used for construction of patios, sidewalks, and driveways. Although it is non-toxic, these paved areas reduce stormwater infiltration and increase the volume and rate of runoff. This increase in the amount of runoff is the leading cause of stream channel degradation in urban areas.

There are a number of alternative materials that can be used in these applications, including porous concrete and asphalt, modular blocks, and crushed granite. These materials, especially modular paving blocks, are widely available and a well established method to reduce stormwater runoff.

### *Building Siding*

Wood siding is commonly used on the exterior of residential construction. This material weathers fairly rapidly and requires repeated painting to prevent rotting. Alternative "new" products for this application include cement-fiber and vinyl. Cement-fiber siding is a masonry product made from Portland cement, sand, and cellulose and will not burn, cup, swell, or shrink.

## Pesticide Reduction

A common use of powerful pesticides is for the control of termites. Chlordane was used for many years for this purpose and is now found in urban streams and lakes nationwide. There are a number of physical barriers that can be installed during construction to help reduce the use of pesticides.

Sand barriers for subterranean termites are a physical deterrent because the termites cannot tunnel through it. Sand barriers can be applied in crawl spaces under pier and beam foundations, under slab foundations, and between the foundation and concrete porches, terraces, patios and steps. Other possible locations include under fence posts, underground electrical cables, water and gas lines, telephone and electrical poles, inside hollow tile cells and against retaining walls.

Metal termite shields are physical barriers to termites which prevent them from building invisible tunnels. In reality, metal shields function as a helpful termite detection device, forcing them to build tunnels on the outside of the shields which are easily seen. Metal termite shields also help prevent dampness from wicking to adjoining wood members which can result in rot, thus making the material more attractive to termites and other pests. Metal flashing and metal plates can also be used as a barrier between piers and beams of structures such as decks, which are particularly vulnerable to termite attack.

## ***Redeveloping Existing Installations***

Various jurisdictional stormwater management and mitigation plans (SUSMP, WQMP, etc.) define “redevelopment” in terms of amounts of additional impervious area, increases in gross floor area and/or exterior construction, and land disturbing activities with structural or impervious surfaces. The definition of “redevelopment” must be consulted to determine whether or not the requirements for new development apply to areas intended for redevelopment. If the definition applies, the steps outlined under “designing new installations” above should be followed.

## **Other Resources**

There are no good, independent, comprehensive sources of information on alternative building materials for use in minimizing the impacts of stormwater runoff. Most websites or other references to “green” or “alternative” building materials focus on indoor applications, such as formaldehyde free plywood and low VOC paints, carpets, and pads. Some supplemental information on alternative materials is available from the manufacturers.

Fires are a source of concern in many areas of California. Information on the flammability of alternative decking materials is available from the University of California Forest Product Laboratory (UCFPL) website at: <http://www.ucfpl.ucop.edu/WDDeckIntro.htm>





Photo Credit: Geoff Brosseau

## Design Objectives

- Maximize Infiltration
- Provide Retention
- Slow Runoff
- Minimize Impervious Land Coverage
- Prohibit Dumping of Improper Materials
- Contain Pollutants
- Collect and Convey

## Description

Fueling areas have the potential to contribute oil and grease, solvents, car battery acid, coolant and gasoline to the stormwater conveyance system. Spills at vehicle and equipment fueling areas can be a significant source of pollution because fuels contain toxic materials and heavy metals that are not easily removed by stormwater treatment devices.

## Approach

Project plans must be developed for cleaning near fuel dispensers, emergency spill cleanup, containment, and leak prevention.

## Suitable Applications

Appropriate applications include commercial, industrial, and any other areas planned to have fuel dispensing equipment, including retail gasoline outlets, automotive repair shops, and major non-retail dispensing areas.

## Design Considerations

Design requirements for fueling areas are governed by Building and Fire Codes and by current local agency ordinances and zoning requirements. Design requirements described in this fact sheet are meant to enhance and be consistent with these code and ordinance requirements.

## *Designing New Installations*

### *Covering*



Fuel dispensing areas should provide an overhanging roof structure or canopy. The cover's minimum dimensions must be equal to or greater than the area within the grade break. The cover must not drain onto the fuel dispensing area and the downspouts must be routed to prevent drainage across the fueling area. The fueling area should drain to the project's treatment control BMP(s) prior to discharging to the stormwater conveyance system. Note - If fueling large equipment or vehicles that would prohibit the use of covers or roofs, the fueling island should be designed to sufficiently accommodate the larger vehicles and equipment and to prevent stormwater run-on and runoff. Grade to direct stormwater to a dead-end sump.

### *Surfacing*

Fuel dispensing areas should be paved with Portland cement concrete (or equivalent smooth impervious surface). The use of asphalt concrete should be prohibited. Use asphalt sealant to protect asphalt paved areas surrounding the fueling area. This provision may be made to sites that have pre-existing asphalt surfaces.

The concrete fuel dispensing area should be extended a minimum of 6.5 ft from the corner of each fuel dispenser, or the length at which the hose and nozzle assembly may be operated plus 1 ft, whichever is less.

### *Grading/Contouring*

Dispensing areas should have an appropriate slope to prevent ponding, and be separated from the rest of the site by a grade break that prevents run-on of urban runoff. (Slope is required to be 2 to 4% in some jurisdictions' stormwater management and mitigation plans.)

Fueling areas should be graded to drain toward a dead-end sump. Runoff from downspouts/roofs should be directed away from fueling areas. Do not locate storm drains in the immediate vicinity of the fueling area.

### ***Redeveloping Existing Installations***

Various jurisdictional stormwater management and mitigation plans (SUSMP, WQMP, etc.) define "redevelopment" in terms of amounts of additional impervious area, increases in gross floor area and/or exterior construction, and land disturbing activities with structural or impervious surfaces. The definition of "redevelopment" must be consulted to determine whether or not the requirements for new development apply to areas intended for redevelopment. If the definition applies, the steps outlined under "designing new installations" above should be followed.

### **Additional Information**

- In the case of an emergency, provide storm drain seals, such as isolation valves, drain plugs, or drain covers, to prevent spills or contaminated stormwater from entering the stormwater conveyance system.

### **Other Resources**

A Manual for the Standard Urban Stormwater Mitigation Plan (SUSMP), Los Angeles County Department of Public Works, May 2002.

Model Standard Urban Storm Water Mitigation Plan (SUSMP) for San Diego County, Port of San Diego, and Cities in San Diego County, February 14, 2002.

Model Water Quality Management Plan (WQMP) for County of Orange, Orange County Flood Control District, and the Incorporated Cities of Orange County, Draft February 2003.

Ventura Countywide Technical Guidance Manual for Stormwater Quality Control Measures, July 2002.







## Design Objectives

- Maximize Infiltration
- Provide Retention
- Slow Runoff
- Minimize Impervious Land Coverage
- Prohibit Dumping of Improper Materials
- Contain Pollutants
- Collect and Convey

## Description

Several measures can be taken to prevent operations at maintenance bays and loading docks from contributing a variety of toxic compounds, oil and grease, heavy metals, nutrients, suspended solids, and other pollutants to the stormwater conveyance system.

## Approach

In designs for maintenance bays and loading docks, containment is encouraged. Preventative measures include overflow containment structures and dead-end sumps. However, in the case of loading docks from grocery stores and warehouse/distribution centers, engineered infiltration systems may be considered.

## Suitable Applications

Appropriate applications include commercial and industrial areas planned for development or redevelopment.

## Design Considerations

Design requirements for vehicle maintenance and repair are governed by Building and Fire Codes, and by current local agency ordinances, and zoning requirements. The design criteria described in this fact sheet are meant to enhance and be consistent with these code requirements.

## *Designing New Installations*

Designs of maintenance bays should consider the following:

- Repair/maintenance bays and vehicle parts with fluids should be indoors; or designed to preclude urban run-on and runoff.
- Repair/maintenance floor areas should be paved with Portland cement concrete (or equivalent smooth impervious surface).



- Repair/maintenance bays should be designed to capture all wash water leaks and spills. Provide impermeable berms, drop inlets, trench catch basins, or overflow containment structures around repair bays to prevent spilled materials and wash-down waters from entering the storm drain system. Connect drains to a sump for collection and disposal. Direct connection of the repair/maintenance bays to the storm drain system is prohibited. If required by local jurisdiction, obtain an Industrial Waste Discharge Permit.
- Other features may be comparable and equally effective.

The following designs of loading/unloading dock areas should be considered:

- Loading dock areas should be covered, or drainage should be designed to preclude urban run-on and runoff.
- Direct connections into storm drains from depressed loading docks (truck wells) are prohibited.
- Below-grade loading docks from grocery stores and warehouse/distribution centers of fresh food items should drain through water quality inlets, or to an engineered infiltration system, or an equally effective alternative. Pre-treatment may also be required.
- Other features may be comparable and equally effective.

### ***Redeveloping Existing Installations***

Various jurisdictional stormwater management and mitigation plans (SUSMP, WQMP, etc.) define “redevelopment” in terms of amounts of additional impervious area, increases in gross floor area and/or exterior construction, and land disturbing activities with structural or impervious surfaces. The definition of “redevelopment” must be consulted to determine whether or not the requirements for new development apply to areas intended for redevelopment. If the definition applies, the steps outlined under “designing new installations” above should be followed.

### **Additional Information**

Stormwater and non-stormwater will accumulate in containment areas and sumps with impervious surfaces. Contaminated accumulated water must be disposed of in accordance with applicable laws and cannot be discharged directly to the storm drain or sanitary sewer system without the appropriate permit.

### **Other Resources**

A Manual for the Standard Urban Stormwater Mitigation Plan (SUSMP), Los Angeles County Department of Public Works, May 2002.

Model Standard Urban Storm Water Mitigation Plan (SUSMP) for San Diego County, Port of San Diego, and Cities in San Diego County, February 14, 2002.

Model Water Quality Management Plan (WQMP) for County of Orange, Orange County Flood Control District, and the Incorporated Cities of Orange County, Draft February 2003.

Ventura Countywide Technical Guidance Manual for Stormwater Quality Control Measures, July 2002.

## Description

Trash storage areas are areas where a trash receptacle (s) are located for use as a repository for solid wastes. Stormwater runoff from areas where trash is stored or disposed of can be polluted. In addition, loose trash and debris can be easily transported by water or wind into nearby storm drain inlets, channels, and/or creeks. Waste handling operations that may be sources of stormwater pollution include dumpsters, litter control, and waste piles.

## Approach

This fact sheet contains details on the specific measures required to prevent or reduce pollutants in stormwater runoff associated with trash storage and handling. Preventative measures including enclosures, containment structures, and impervious pavements to mitigate spills, should be used to reduce the likelihood of contamination.

## Suitable Applications

Appropriate applications include residential, commercial and industrial areas planned for development or redevelopment. (Detached residential single-family homes are typically excluded from this requirement.)

## Design Considerations

Design requirements for waste handling areas are governed by Building and Fire Codes, and by current local agency ordinances and zoning requirements. The design criteria described in this fact sheet are meant to enhance and be consistent with these code and ordinance requirements. Hazardous waste should be handled in accordance with legal requirements established in Title 22, California Code of Regulation.

Wastes from commercial and industrial sites are typically hauled by either public or commercial carriers that may have design or access requirements for waste storage areas. The design criteria in this fact sheet are recommendations and are not intended to be in conflict with requirements established by the waste hauler. The waste hauler should be contacted prior to the design of your site trash collection areas. Conflicts or issues should be discussed with the local agency.

## *Designing New Installations*

Trash storage areas should be designed to consider the following structural or treatment control BMPs:

- Design trash container areas so that drainage from adjoining roofs and pavement is diverted around the area(s) to avoid run-on. This might include berming or grading the waste handling area to prevent run-on of stormwater.
- Make sure trash container areas are screened or walled to prevent off-site transport of trash.

## Design Objectives

- Maximize Infiltration
- Provide Retention
- Slow Runoff
- Minimize Impervious Land Coverage
- Prohibit Dumping of Improper Materials
- Contain Pollutants
- Collect and Convey



- Use lined bins or dumpsters to reduce leaking of liquid waste.
- Provide roofs, awnings, or attached lids on all trash containers to minimize direct precipitation and prevent rainfall from entering containers.
- Pave trash storage areas with an impervious surface to mitigate spills.
- Do not locate storm drains in immediate vicinity of the trash storage area.
- Post signs on all dumpsters informing users that hazardous materials are not to be disposed of therein.

### ***Redeveloping Existing Installations***

Various jurisdictional stormwater management and mitigation plans (SUSMP, WQMP, etc.) define “redevelopment” in terms of amounts of additional impervious area, increases in gross floor area and/or exterior construction, and land disturbing activities with structural or impervious surfaces. The definition of “redevelopment” must be consulted to determine whether or not the requirements for new development apply to areas intended for redevelopment. If the definition applies, the steps outlined under “designing new installations” above should be followed.

### **Additional Information**

#### ***Maintenance Considerations***

The integrity of structural elements that are subject to damage (i.e., screens, covers, and signs) must be maintained by the owner/operator. Maintenance agreements between the local agency and the owner/operator may be required. Some agencies will require maintenance deed restrictions to be recorded of the property title. If required by the local agency, maintenance agreements or deed restrictions must be executed by the owner/operator before improvement plans are approved.

### **Other Resources**

A Manual for the Standard Urban Stormwater Mitigation Plan (SUSMP), Los Angeles County Department of Public Works, May 2002.

Model Standard Urban Storm Water Mitigation Plan (SUSMP) for San Diego County, Port of San Diego, and Cities in San Diego County, February 14, 2002.

Model Water Quality Management Plan (WQMP) for County of Orange, Orange County Flood Control District, and the Incorporated Cities of Orange County, Draft February 2003.

Ventura Countywide Technical Guidance Manual for Stormwater Quality Control Measures, July 2002.



Photo Credit: Geoff Brosseau

## Design Objectives

- Maximize Infiltration
  - Provide Retention
  - Slow Runoff
  - Minimize Impervious Land Coverage
  - Prohibit Dumping of Improper Materials
- Contain Pollutants
- Collect and Convey

## Description

Vehicle washing, equipment washing, and steam cleaning may contribute high concentrations of metals, oil and grease, solvents, phosphates, and suspended solids to wash waters that drain to stormwater conveyance systems.

## Approach

Project plans should include appropriately designed area(s) for washing-steam cleaning of vehicles and equipment. Depending on the size and other parameters of the wastewater facility, wash water may be conveyed to a sewer, an infiltration system, recycling system or other alternative. Pretreatment may be required for conveyance to a sanitary sewer.

## Suitable Applications

Appropriate applications include commercial developments, restaurants, retail gasoline outlets, automotive repair shops and others.

## Design Considerations

Design requirements for vehicle maintenance are governed by Building and Fire Codes, and by current local agency ordinances, and zoning requirements. Design criteria described in this fact sheet are meant to enhance and be consistent with these code requirements.

## *Designing New Installations*

Areas for washing/steam cleaning should incorporate one of the following features:

- Be self-contained and/or covered with a roof or overhang
- Be equipped with a clarifier or other pretreatment facility
- Have a proper connection to a sanitary sewer



- Include other features which are comparable and equally effective

CAR WASH AREAS - Some jurisdictions' stormwater management plans include vehicle-cleaning area source control design requirements for community car wash racks in complexes with a large number of dwelling units. In these cases, wash water from the areas may be directed to the sanitary sewer, to an engineered infiltration system, or to an equally effective alternative. Pre-treatment may also be required.

Depending on the jurisdiction, developers may be directed to divert surface water runoff away from the exposed area around the wash pad ( parking lot, storage areas), and wash pad itself to alternatives other than the sanitary sewer. Roofing may be required for exposed wash pads.

It is generally advisable to cover areas used for regular washing of vehicles, trucks, or equipment, surround them with a perimeter berm, and clearly mark them as a designated washing area. Sumps or drain lines can be installed to collect wash water, which may be treated for reuse or recycling, or for discharge to the sanitary sewer. Jurisdictions may require some form of pretreatment, such as a trap, for these areas.

### ***Redeveloping Existing Installations***

Various jurisdictional stormwater management and mitigation plans (SUSMP, WQMP, etc.) define "redevelopment" in terms of amounts of additional impervious area, increases in gross floor area and/or exterior construction, and land disturbing activities with structural or impervious surfaces. The definition of "redevelopment" must be consulted to determine whether or not the requirements for new development apply to areas intended for redevelopment.

### **Additional Information**

#### ***Maintenance Considerations***

Stormwater and non-stormwater will accumulate in containment areas and sumps with impervious surfaces. Contaminated accumulated water must be disposed of in accordance with applicable laws and cannot be discharged directly to the storm drain or sanitary sewer system without the appropriate permit.

### **Other Resources**

A Manual for the Standard Urban Stormwater Mitigation Plan (SUSMP), Los Angeles County Department of Public Works, May 2002.

Model Standard Urban Storm Water Mitigation Plan (SUSMP) for San Diego County, Port of San Diego, and Cities in San Diego County, February 14, 2002.

Model Water Quality Management Plan (WQMP) for County of Orange, Orange County Flood Control District, and the Incorporated Cities of Orange County, Draft February 2003.

Ventura Countywide Technical Guidance Manual for Stormwater Quality Control Measures, July 2002.



## Design Objectives

- Maximize Infiltration
- Provide Retention
- Slow Runoff
- Minimize Impervious Land Coverage
- Prohibit Dumping of Improper Materials
- Contain Pollutant
- Collect and Convey

## Description

Proper design of outdoor storage areas for materials reduces opportunity for toxic compounds, oil and grease, heavy metals, nutrients, suspended solids, and other pollutants to enter the stormwater conveyance system. Materials may be in the form of raw products, by-products, finished products, and waste products. The type of pollutants associated with the materials will vary depending on the type of commercial or industrial activity.

## Approach

Outdoor storage areas require a drainage approach different from the typical infiltration/detention strategy. In outdoor storage areas, infiltration is discouraged. Containment is encouraged. Preventative measures include enclosures, secondary containment structures and impervious surfaces.

## Suitable Applications

Appropriate applications include residential, commercial and industrial areas planned for development or redevelopment.

## Design Considerations

Some materials are more of a concern than others. Toxic and hazardous materials must be prevented from coming in contact with stormwater. Non-toxic or non-hazardous materials do not have to be prevented from stormwater contact. However, these materials may have toxic effects on receiving waters if allowed to be discharged with stormwater in significant quantities. Accumulated material on an impervious surface could result in significant impact on the rivers or streams that receive the runoff.

Material may be stored in a variety of ways, including bulk piles, containers, shelving, stacking, and tanks. Stormwater contamination may be prevented by eliminating the possibility of stormwater contact with the material storage areas either through diversion, cover, or capture of the stormwater. Control measures may also include minimizing the storage area. Design



# SD-34 Outdoor Material Storage Areas

---

requirements for material storage areas are governed by Building and Fire Codes, and by current City or County ordinances and zoning requirements. Control measures are site specific, and must meet local agency requirements.

## ***Designing New Installations***

Where proposed project plans include outdoor areas for storage of materials that may contribute pollutants to the stormwater conveyance system, the following structural or treatment BMPS should be considered:

- Materials with the potential to contaminate stormwater should be: (1) placed in an enclosure such as, but not limited to, a cabinet, shed, or similar structure that prevents contact with runoff or spillage to the stormwater conveyance system, or (2) protected by secondary containment structures such as berms, dikes, or curbs.
- The storage area should be paved and sufficiently impervious to contain leaks and spills.
- The storage area should slope towards a dead-end sump to contain spills and direct runoff from downspouts/roofs should be directed away from storage areas.
- The storage area should have a roof or awning that extends beyond the storage area to minimize collection of stormwater within the secondary containment area. A manufactured storage shed may be used for small containers.

Note that the location(s) of installations of where these preventative measures will be employed must be included on the map or plans identifying BMPs.

## ***Redeveloping Existing Installations***

Various jurisdictional stormwater management and mitigation plans (SUSMP, WQMP, etc.) define “redevelopment” in terms of amounts of additional impervious area, increases in gross floor area and/or exterior construction, and land disturbing activities with structural or impervious surfaces. The definition of “redevelopment” must be consulted to determine whether or not the requirements for new development apply to areas intended for redevelopment. If the definition applies, the steps outlined under “designing new installations” above should be followed.

## **Additional Information**

Stormwater and non-stormwater will accumulate in containment areas and sumps with impervious surfaces. Contaminated accumulated water must be disposed of in accordance with applicable laws and cannot be discharged directly to the storm drain or sanitary sewer system without the appropriate permits.

## **Other Resources**

A Manual for the Standard Urban Stormwater Mitigation Plan (SUSMP), Los Angeles County Department of Public Works, May 2002.

Model Standard Urban Storm Water Mitigation Plan (SUSMP) for San Diego County, Port of San Diego, and Cities in San Diego County, February 14, 2002.



# **Outdoor Material Storage Areas      SD-34**

---

Model Water Quality Management Plan (WQMP) for County of Orange, Orange County Flood Control District, and the Incorporated Cities of Orange County, Draft February 2003.

Ventura Countywide Technical Guidance Manual for Stormwater Quality Control Measures, July 2002.





Photo Credit: Geoff Brosseau

## Design Objectives

- Maximize Infiltration
- Provide Retention
- Slow Runoff
- Minimize Impervious Land Coverage
- Prohibit Dumping of Improper Materials
- Contain Pollutant
- Collect and Convey

## Description

Proper design of outdoor work areas for materials reduces opportunity for toxic compounds, oil and grease, heavy metals, nutrients, suspended solids, and other pollutants to enter the stormwater conveyance system.

## Approach

Outdoor work areas require a drainage approach different from the typical infiltration/detention strategy. In outdoor work areas, infiltration is discouraged; collection and conveyance are encouraged. In outdoor work areas, infiltration is discouraged and runoff is often routed directly to the sanitary sewer, not the storm drain. Because this runoff is being added to the loads normally received by the wastewater treatment plants, municipal stormwater programs and/or private developers must work with the local plant to develop solutions that minimize effects on the treatment facility. These concerns are best addressed in the planning and design stage of the outdoor work area.

## Suitable Applications

Appropriate applications include residential, commercial, and industrial areas planned for development or redevelopment.

## Design Considerations

Design requirements for outdoor work areas are governed by Building and Fire Codes, and by current local agency ordinances, and zoning requirements.

## *Designing New Installations*

Outdoor work areas can be designed in particular ways to reduce impacts on both stormwater quality and sewage treatment plants.

- Create an impermeable surface such as concrete or asphalt, or a prefabricated metal drip pan, depending on the use.



- Cover the area with a roof. This prevents rain from falling on the work area and becoming polluted runoff.
- Berm or perform mounding around the perimeter of the area to prevent water from adjacent areas from flowing on to the surface of the work area.
- Directly connect runoff. Unlike other areas, runoff from work areas is directly connected to the sanitary sewer or other specialized containment system(s). This allows the more highly concentrated pollutants from these areas to receive special treatment that removes particular constituents. Approval for this connection must be obtained from the appropriate sanitary sewer agency.
- Locate the work area away from storm drains or catch basins.

### ***Redeveloping Existing Installations***

Various jurisdictional stormwater management and mitigation plans (SUSMP, WQMP, etc.) define “redevelopment” in terms of amounts of additional impervious area, increases in gross floor area and/or exterior construction, and land disturbing activities with structural or impervious surfaces. The definition of “redevelopment” must be consulted to determine whether or not the requirements for new development apply to areas intended for redevelopment. If the definition applies, the steps outlined under “designing new installations” above should be followed.

### **Other Resources**

A Manual for the Standard Urban Stormwater Mitigation Plan (SUSMP), Los Angeles County Department of Public Works, May 2002.

Model Standard Urban Storm Water Mitigation Plan (SUSMP) for San Diego County, Port of San Diego, and Cities in San Diego County, February 14, 2002.

Model Water Quality Management Plan (WQMP) for County of Orange, Orange County Flood Control District, and the Incorporated Cities of Orange County, Draft February 2003.

Ventura Countywide Technical Guidance Manual for Stormwater Quality Control Measures, July 2002.

## Description

Outdoor process equipment operations such as rock grinding or crushing, painting or coating, grinding or sanding, degreasing or parts cleaning, landfills, waste piles, wastewater and solid waste treatment and disposal, and others operations may contribute a variety of toxic compounds, oil and grease, heavy metals, nutrients, suspended solids, and other pollutants to the storm conveyance system.

## Approach

Outdoor processing areas require a drainage approach different from the typical infiltration/detention strategy. In outdoor process equipment areas, infiltration is discouraged. Containment is encouraged, accompanied by collection and conveyance. Preventative measures include enclosures, secondary containment structures, dead-end sumps, and conveyance to treatment facilities in accordance with conditions established by the applicable sewer agency.

## Suitable Applications

Appropriate applications include commercial and industrial areas planned for development or redevelopment.

## Design Considerations

Design requirements for outdoor processing areas are governed by Building and Fire codes, and by current local agency ordinances, and zoning requirements.

## *Designing New Installations*

Operations determined to be a potential threat to water quality should consider to the following recommendations:

- Cover or enclose areas that would be the most significant source of pollutants; or slope the area toward a dead-end sump; or, discharge to the sanitary sewer system following appropriate treatment in accordance with conditions established by the applicable sewer agency.
- Grade or berm area to prevent run-on from surrounding areas.
- Do not install storm drains in areas of equipment repair.
- Consider other features that are comparable or equally effective.
- Provide secondary containment structures (not double wall containers) where wet material processing occurs (e.g., electroplating), to hold spills resulting from accidents, leaking tanks, or equipment, or any other unplanned releases (Note:

## Design Objectives

- Maximize Infiltration
- Provide Retention
- Slow Runoff
- Minimize Impervious Land Coverage
- Prohibit Dumping of Improper Materials
- Contain Pollutants
- Collect and Convey



if these are plumbed to the sanitary sewer, they must be with the prior approval of the sewerage agency.)

***Redeveloping Existing Installations***

Various jurisdictional stormwater management and mitigation plans (SUSMP, WQMP, etc.) define “redevelopment” in terms of amounts of additional impervious area, increases in gross floor area and/or exterior construction, and land disturbing activities with structural or impervious surfaces. The definition of “redevelopment” must be consulted to determine whether or not the requirements for new development apply to areas intended for redevelopment. If the definition applies, the steps outlined under “designing new installations” above should be followed.

**Additional Information**

Stormwater and non-stormwater will accumulate in containment areas and sumps with impervious surfaces. Contaminated accumulated water must be disposed of in accordance with applicable laws and cannot be discharged directly to the storm drain or sanitary sewer system without the appropriate permit.

**Other Resources**

A Manual for the Standard Urban Stormwater Mitigation Plan (SUSMP), Los Angeles County Department of Public Works, May 2002.

Model Standard Urban Storm Water Mitigation Plan (SUSMP) for San Diego County, Port of San Diego, and Cities in San Diego County, February 14, 2002.

Model Water Quality Management Plan (WQMP) for County of Orange, Orange County Flood Control District, and the Incorporated Cities of Orange County, Draft February 2003.

Ventura Countywide Technical Guidance Manual for Stormwater Quality Control Measures, July 2002.

# Section 5

## Treatment Control BMPs

### 5.1 Introduction

This section describes treatment control Best Management Practices (BMPs) to be considered for incorporation into newly developed public and private infrastructure, as well as retrofit into existing facilities to meet stormwater management objectives. BMP fact sheets are divided into two groups: public domain BMPs and manufactured (proprietary) BMPs. In some cases, the same BMP may exist in each group, for example, media filtration. However, treatment BMPs are typically very different between the two groups.

Brand names of manufactured BMPs are not stated. Descriptions of manufactured BMPs in this document should not be inferred as endorsement by the authors.

### 5.2 Treatment Control BMPs

Public domain and manufactured BMP controls are listed in Table 5-1.

<b>Table 5-1 Treatment Control BMPs</b>	
<b>Public Domain</b>	<b>Manufactured (Proprietary)</b>
<b>Infiltration</b>	<b>Infiltration</b>
TC-10 Infiltration Trench	
TC-11 Infiltration Basin	
TC-12 Retention/Irrigation	
<b>Detention and Settling</b>	<b>Detention and Settling</b>
TC-20 Wet Pond	MP-20 Wetland
TC-21 Constructed Wetland	
TC-22 Extended Detention Basin	
<b>Biofiltration</b>	<b>Biofiltration</b>
TC-30 Vegetated Swale	
TC-31 Vegetated Buffer Strip	
TC-32 Bioretention	
<b>Filtration</b>	<b>Filtration</b>
TC-40 Media Filter	MP-40 Media Filter
<b>Flow Through Separation</b>	<b>Flow Through Separation</b>
TC-50 Water Quality Inlet	MP-50 Wet Vault
	MP-51 Vortex Separator
	MP-52 Drain Inserts
<b>Other</b>	<b>Other</b>
TC-60 Multiple Systems	

## 5.3 Fact Sheet Format

A BMP fact sheet is a short document that gives all the information about a particular BMP. Typically, each public domain and manufactured BMP fact sheet contains the information outlined in Figure 5-1. The fact sheets also contain side bar presentations with information on BMP design considerations, targeted constituents, and removal effectiveness (if known).

Treatment BMP performance, design criteria, and other selection factors are discussed in 5.4 – 5.6 below. BMP Fact sheets are included in 5.7.

TCxx/MPxx Example Fact Sheet
<u>Description</u>
<u>California Experience</u>
<u>Advantages</u>
<u>Limitations</u>
<u>Design and Sizing Guidelines</u>
<u>Performance</u>
<u>Siting Criteria</u>
<u>Design Guidelines</u>
<u>Maintenance</u>
<u>Cost</u>
<u>References and Sources of Additional Information</u>

Figure 5-1  
Example Fact Sheet

## 5.4 Comparing Performance of Treatment BMPs

With a myriad of stormwater treatment BMPs from which to choose, a question commonly asked is “which one is best”. Particularly when considering a manufactured treatment system, the engineer wants to know if it provides performance that is reasonably comparable to the typical public-domain BMPs like wet ponds or grass swales. With so many BMPs, it is not likely that they perform equally for all pollutants. Thus, the question that each local jurisdiction faces is which treatment BMPs will it allow, and under what circumstances. What level of treatment is desired or reasonable, given the cost? Which BMPs are the most cost-effective? Current municipal stormwater permits specify the volume or rate of stormwater that must be treated, but not the specific level or efficiency of treatment: These permits usually require performance to the specific maximum extent practicable (MEP), but this does not translate to an easy to apply specific design criteria.

Methodology for comparing BMP performance may need to be expanded to include more than removal effectiveness. Many studies have been conducted on the performance of stormwater treatment BMPs. Several publications have provided summaries of performance (ASCE, 1998; ASCE, 2001; Brown and Schueler, 1997; Shoemaker et al., 2000; Winter, 2001). These summaries indicate a wide variation in the performance of each type of BMP, making effectiveness comparisons between BMPs problematic.

### 5.4.1 Variation in Performance

There are several reasons for the observed variation.

#### The Variability of Stormwater Quality

Stormwater quality is highly variable during a storm, from storm to storm at a site, and between sites even of the same land use. For pollutants of interest, maximum observed concentrations commonly exceed the average concentration by a factor of 100. The average concentration of a storm, known as the event mean concentration (EMC) commonly varies at a site by a factor of 5. One aspect of stormwater quality that is highly variable is the particle size distribution (PSD) of



the suspended sediments. This results in variation in the settle ability of these sediments and the pollutants that are attached. For example, several performance studies of manufactured BMPs have been conducted in the upper Midwest and Northeast where deicing sand is commonly used. The sand, washed off during spring and summer storms, skews the PSD to larger sizes not commonly found in stormwater from California sites except in mountainous areas. Consequently, a lower level efficiency may be observed if the same treatment system is used in California.

### **Most Field Studies Monitor Too Few Storms**

High variability of stormwater quality requires that a large number of storms be sampled to discern if there is a significant difference in performance among BMPs. The smaller the actual difference in performance between BMPs, the greater the number of storms that must be sampled to statistically discern the difference between them. For example, a researcher attempting to determine a difference in performance between two BMPs of 10% must monitor many more storms than if the interest is to define the difference within 50%. Given the expense and difficulty, few studies have monitored enough storms to determine the actual performance with a high level of precision.

### **Different Design Criteria**

Performance of different systems within the same group (e.g., wet ponds) differs significantly in part because of differing design criteria for each system. This in turn can make it problematic to compare different groups of treatment BMPs to each other (e.g., wet ponds to vortex separators).

### **Differing Influent Concentrations and Analytical Variability**

With most treatment BMPs, efficiency decreases with decreasing influent concentration. This is illustrated in Figure 5-2. Thus, a low removal efficiency may be observed during a study not because the device is inherently a poorer performer, but possibly because the influent concentrations for the site were unusually low. In addition, as the concentration of a particular constituent such as TSS approaches its analytical detection limit, the effect of the variability of the laboratory technique becomes more significant. This factor also accounts for the wide variability of observations on the left of Figure 5-2.

The variability of the laboratory results as the TSS approaches its analytical detection limit may also account for negative efficiencies at very low influent concentrations (e.g., TSS less than 10 mg/L). However, some negative efficiencies observed at higher concentrations may not necessarily be an artifact of laboratory analysis. The cause varies to some extent with the type of treatment BMP. Negative efficiencies may be due to the re-suspension of previously deposited pollutants, a change in pH that dissolves precipitated or sorbed pollutants, discharge of algae in the case of BMPs with open wet pools, erosion of unprotected basin side or bottom, and the degradation of leaves that entered the system the previous fall.

### Different Methods of Calculating Efficiency

Researchers (1) have used different methods to calculate efficiency, (2) do not always indicate which method they have used, and (3) often do not provide sufficient information in their report to allow others to recalculate the efficiency using a common method.

One approach to quantifying BMP efficiency is to determine first if the BMP is providing treatment (that the influent and effluent

mean event mean concentrations are statistically different from one another) and then examine either a cumulative distribution function of influent and effluent quality or a standard parallel probability plot. This approach is called the Effluent Probability Method. While this approach has been used in the past by EPA and ASCE, some researchers have experienced problems with the general applicability of this method. A discussion of these issues is included in Appendix B.

A second approach to comparing performance among BMPs is to compare effluent concentrations, using a box-whisker plot, the basic form of which is illustrated in Figure 5-3. The plot represents all of the data points, of one study, several studies, or of individual storms. The plots provide insight into the variability of performance within each BMP type, and possible differences in performance among the types. To explain the plot: 50% of the data points as well as the median value of all the data points is represented by the box. That is, the median falls within the 75th and 25th percentile of data (top and bottom of the box). The whisker extends to the highest point within a range of 1.5 times the difference between the first and third quartiles. Individual points beyond this range are shown as asterisks.

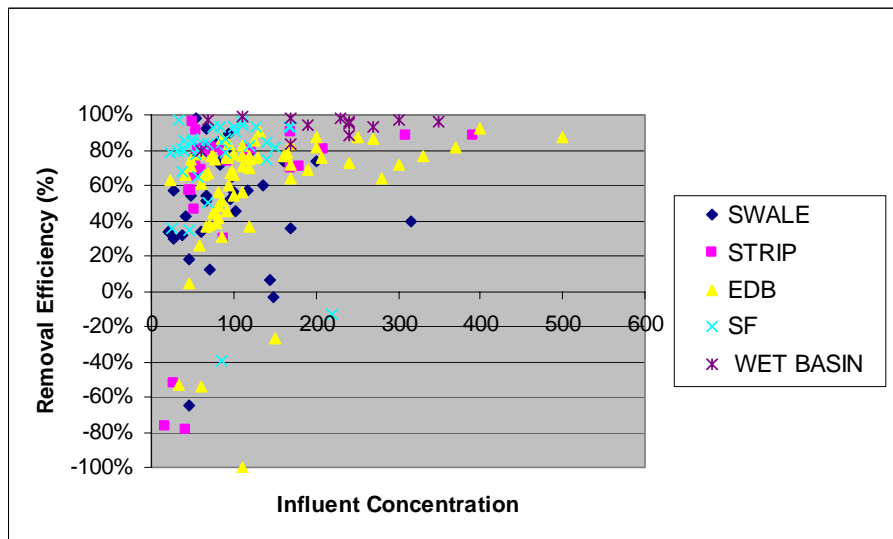

**Figure 5-2**  
**Removal Efficiency Versus Influent Concentration**

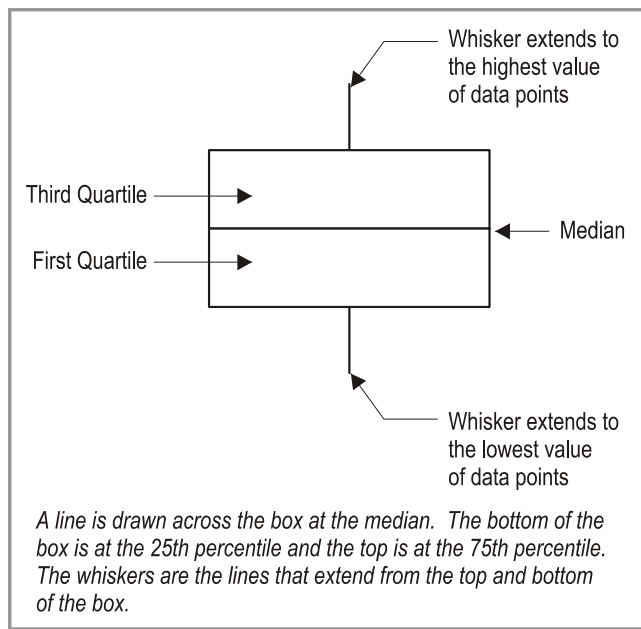

**Figure 5-3**  
**Box-Whisker Plot**

Recognizing the possible effect of influent concentration on efficiency, an alternative is to compare effluent concentrations. The reasoning is that regardless of the influent concentration, a particular BMP will generate a narrower range of effluent concentrations. Figure 5-4 shows observed effluent concentrations for several different types of BMPs. These data were generated in an extensive field program conducted by the California Department of Transportation (Caltrans). As this program is the most extensive effort to date in the entire United States, the observations about performance in this Handbook rely heavily on these data. The Caltrans study is unique in that many of the BMPs were tested under reasonably similar conditions (climate, storms, freeway stormwater quality), with each type of BMP sized with the same design criteria.

An additional factor to consider when comparing BMPs is the effect of infiltration. BMPs with concrete or metal structures will have no infiltration, whereas the infiltration in earthen BMPs will vary from none to substantial. For example, in the Caltrans study, infiltration in vegetated swales averaged nearly 50%. This point is illustrated with Figure 5-4 where effluent quality of several BMPs is compared. As seen in Figure 5-4, effluent concentration for grass swales is higher than either filters or wet basins (30 vs. 10 to 15 mg/L), suggesting that swales in comparison are not particularly effective. However, surface water entering swales may infiltrate into the ground, resulting in a loading reduction (flow times concentration) that is similar to those BMPs with minimal or no infiltration.

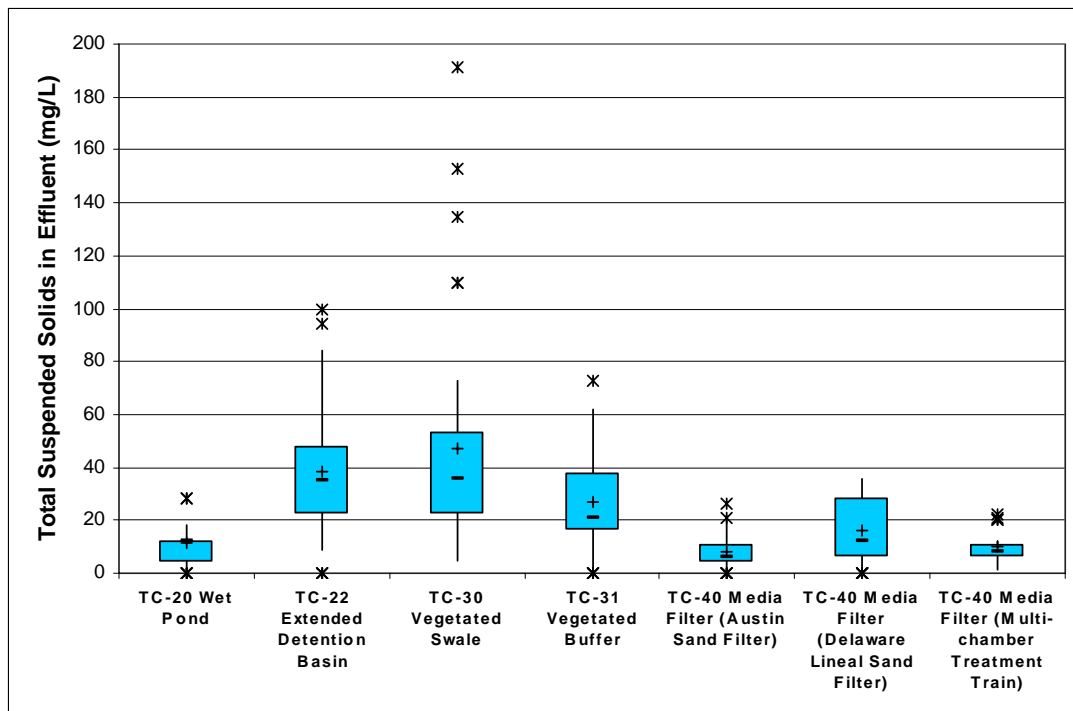

**Figure 5-4**  
**Observed Effluent Concentrations for Several Different Public Domain BMPs**

With equation shown below, it is possible using the data from Figure 5-4 to estimate different levels of loading reduction as a function of the fraction of stormwater that is infiltrated.

$$EEC = (1-I)(EC) + (I)(GC)$$

Where:

EEC = the effective effluent concentration

I = fraction of stormwater discharged by infiltration

EC = the median concentration observed in the effluent

GC = expected concentration of stormwater when it reaches the groundwater

To illustrate the use of the equation above, the effect of infiltration is considered on the effective effluent concentration of TSS from swales. From Figure 5-4, the median effluent concentration for swales is about 30 mg/L. Infiltration of 50% is assumed with an expected concentration of 5 mg/L when the stormwater reaches the groundwater. This gives:

$$EEC = (1-0.5)(30) + (0.5)(5) = 17.5 \text{ mg/L.}$$

The above value can be compared to other BMPs that may directly produce a lower effluent concentration, but do not exhibit infiltration, such as concrete wet vaults.

### 5.4.2 Other Issues Related to Performance Comparisons

A further consideration related to performance comparisons is whether or not the treatment BMP removes dissolved pollutants. Receiving water standards for most metals are based on the dissolved fraction; the form of nitrogen or phosphorus of most concern as a nutrient is the dissolved fraction.

The common practice of comparing the performance of BMPs using TSS may not be considered sufficient by local governments and regulatory agencies, as there is not always a strong, consistent relationship between TSS and the pollutants of interest, particularly those identified in the 303d list for specific water bodies in California. These pollutants frequently include metals, nitrogen, nutrients (but often nutrients without specifying nitrogen or phosphorus), indicator bacteria (i.e., fecal coliform), pesticides, and trash. Less commonly cited pollutants include sediment, PAHs, PCBs, and dioxin. With respect to metals, typically, only the general term is used. In some cases, a specific metal is identified. The most commonly listed metals are mercury, copper, lead, selenium, zinc, and nickel. Less frequently listed metals are cadmium, arsenic, silver, chromium, molybdenum, and thallium. Commonly, only the general term "metals" is indicated for a water body without reference to a particular metal.

It is desirable to know how each of the treatment BMPs performs with respect to the removal of the above pollutants. Unfortunately, the performance data are non-existent or very limited for many of the cited pollutants, particularly trash, PAHs, PCBs, dioxin, mercury, selenium, and pesticides. Furthermore, the concentrations of these constituents are very low, often below the

detection limit. This prevents the determination of which BMPs are most effective. However, with the exception of trash and possibly dioxin, these pollutants readily sorb to sediments in stormwater, and therefore absent data at this time can be considered to be removed in proportion to the removal of TSS (i.e., sediment.) Therefore, in general, those treatment systems that are most effective at removing TSS will be most effective at removing pollutants noted above.

While there is little data on the removal of trash, those treatment BMPs that include a basin such as a wet pond or vault, or extended detention basin should be similarly effective at removing trash as long as the design incorporates a means of retaining the floating trash in the BMP. Whether or not manufactured products that are configured as a basin (e.g., round vaults or vortex separators) are as effective as public domain BMPs is unknown. However, their ability to retain floating debris may be limited by the fact that many of these products are relatively small and therefore may have limited storage capacity. Only one manufactured BMP is specifically designed to remove floating debris.

There are considerable amounts of performance data for zinc, copper, and lead, with a less substantial database for nickel, cadmium, and chromium. An exception is high-use freeways where metals in general are at higher concentrations than residential and commercial properties. Lead sorbs easily to the sediments in stormwater, with typically only 10% in the dissolved phase. Hence, its removal is generally in direct proportion to the removal of TSS. In contrast, zinc, copper, and cadmium are highly soluble with 50% or more in the dissolved phase. Hence, two treatment BMPs may remove TSS at the same level, but if one is capable of removing dissolved metals, it provides better treatment overall for the more soluble metals.

### **5.4.3 Comparisons of Treatment BMPs for Nitrogen, Zinc, Bacteria, and TSS**

Presented in Figures 5-5 through 5-8 are comparisons of the effluent concentrations produced by several types of treatment BMPs for nitrogen, zinc, and fecal coliform, respectively (TSS is represented in Figure 5-4). Graphs for other metals are provided in Appendix C. These data are from the Caltrans study previously cited. Total and the dissolved effluent concentrations are shown for zinc. (Note that while box-whisker plots are used here to compare BMPs, other methodologies, such as effluent cumulative probability distribution plots, are used by others.)

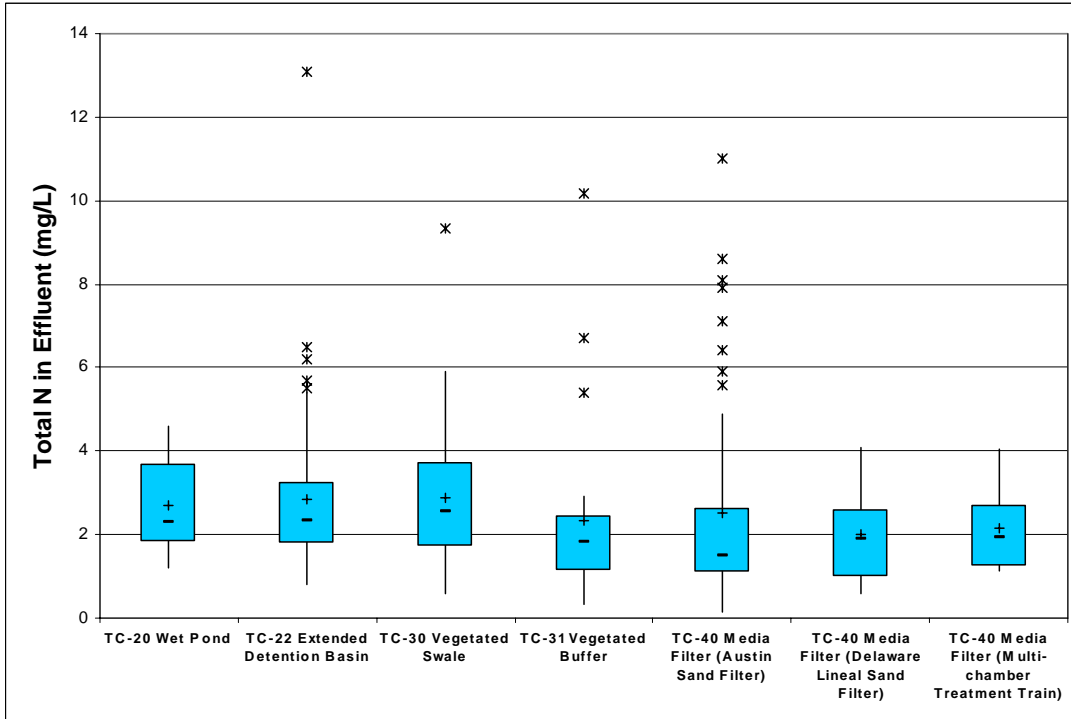

Figure 5-5  
Total Nitrogen in Effluent

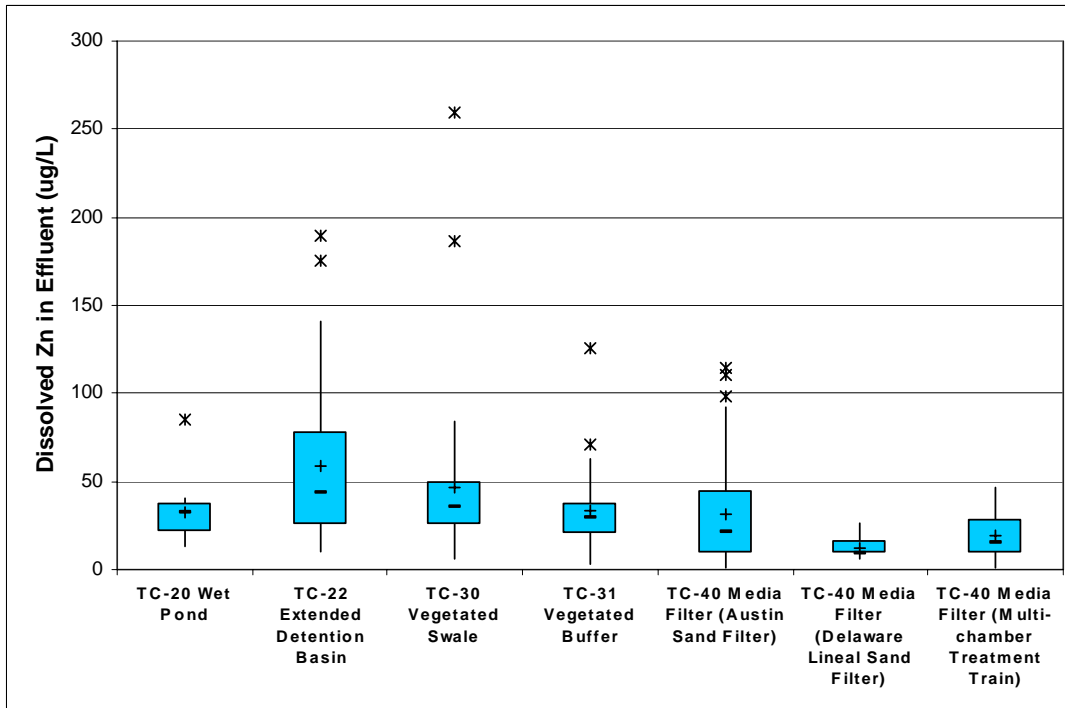

Figure 5-6  
Total Dissolved Zinc in Effluent

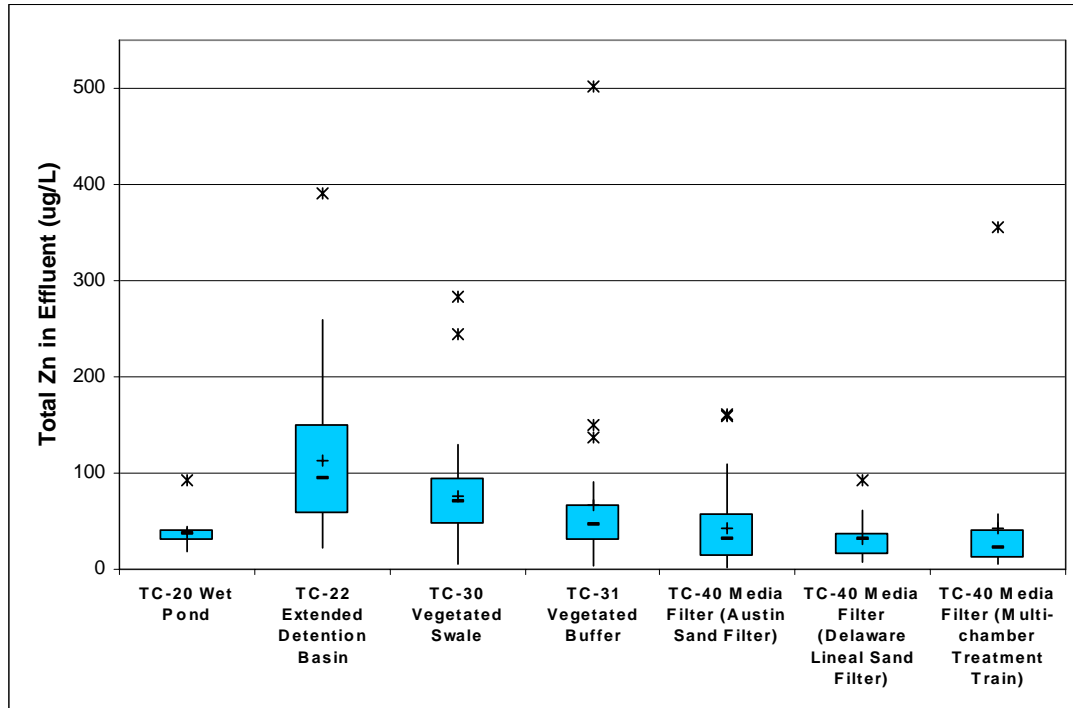

Figure 5-7  
Total Zinc in Effluent

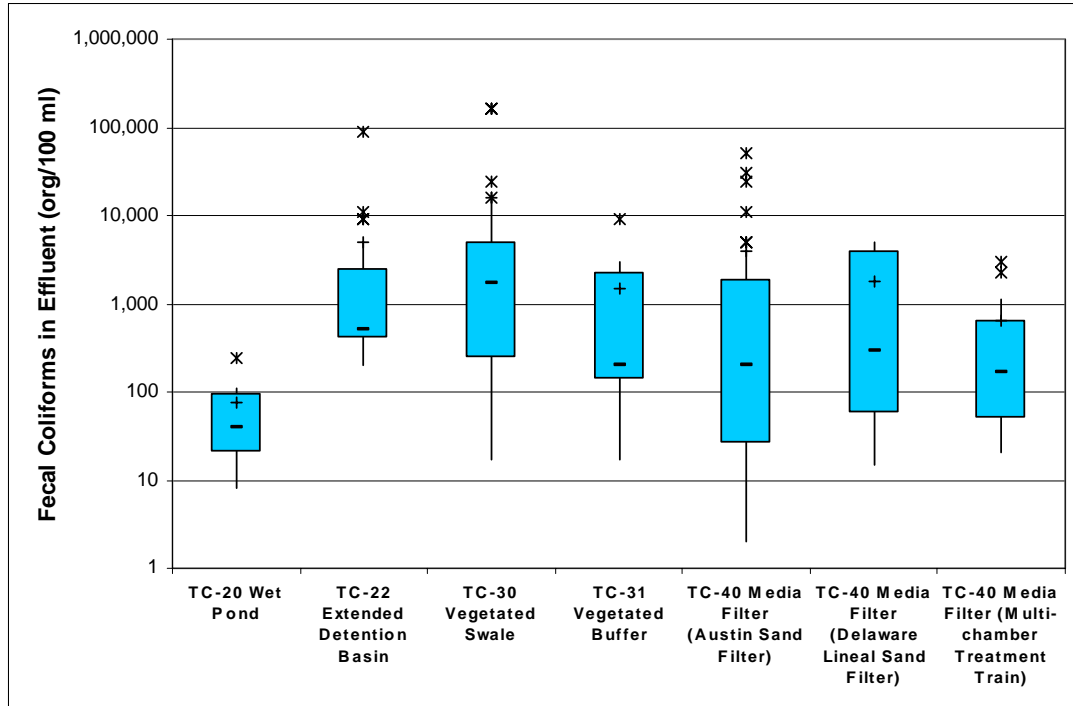

Figure 5-8  
Total Fecal Coliforms in Effluent

While a figure is provided for fecal coliform, it is important to stress that the performance comparisons between BMPs is problematic. Some California BMP studies have shown excellent removal of fecal coliform through constructed wetlands and other BMPs. However, BMP comparisons are complicated by the fact that several BMPs attract wildlife and pets, thereby elevating bacteria levels. As bacteria sorb to the suspended sediments, a significant fraction may be removed by settling or filtration. A cautionary note regarding nitrogen: when comparing nitrogen removal between treatment systems it is best to use the parameter total nitrogen. It consists of Total Kjeldahl Nitrogen – TKN (organic nitrogen plus ammonia) plus nitrate. Comparing TKN removal rates is misleading in that in some treatment systems the ammonia is changed to nitrate but not removed. Examination of the performance data of many systems shows that while TKN may decrease dramatically, the nitrate concentration increases correspondingly. Hence, the overall removal of nitrogen is considerably lower than implied from looking only at Kjeldahl Nitrogen.

#### 5.4.4 General Performance of Manufactured BMPs

An important question is how the performance of manufactured treatment BMPs compares to those in the public domain, illustrated previously in Figures 5-4 through 5-8. Figure 5-9 (and Figure 5-10 in log format) presents box-whisker plots of the removal of TSS for the manufactured systems. Data are presented for five general types of manufactured BMPs: wet vaults, drain inserts, constructed wetlands, media filters, and vortex separators. The figures indicate wide ranges in effluent concentrations, reflecting in part the different products and design criteria within each type. Comparing Figures 5-4 and 5-9 suggests that manufactured products may perform as well as the less effective publicdomain BMPs such as swales and extended detention basins (excluding the additional benefits of infiltration with the latter). Manufactured wetlands may perform as well as the most effective publicdomain BMPs; however, the plot presented in Figure 5-9 for the manufactured wetlands represents only five data points. It should be noted that each type of BMP illustrated in Figure 5-9 contains data from more than one product. Performance of particular products within that grouping may not perform as well as even the least effective publicdomain BMPs. This observation is implied by the greater spread within some boxes in Figure 5-9, for example, manufactured wet vaults and vortex separators.

Product performance within each grouping of manufactured BMPs vary as follows:

- Filters – TSS effluent concentrations range from 2 to 280 mg/L, with a median value of 29 mg/L
- Inserts - TSS effluent concentrations range from 4 to 248 mg/L with a median value of 27 mg/L
- Wetlands – TSS effluent concentrations vary little, and have a median value of 1.2 mg/L
- Vaults – TSS effluent concentrations range from 1 to 467 mg/L, with a median value of 36 mg/L
- Vortex – TSS effluent concentrations range from 13 to 359 mg/L, with a median value of 32 mg/L



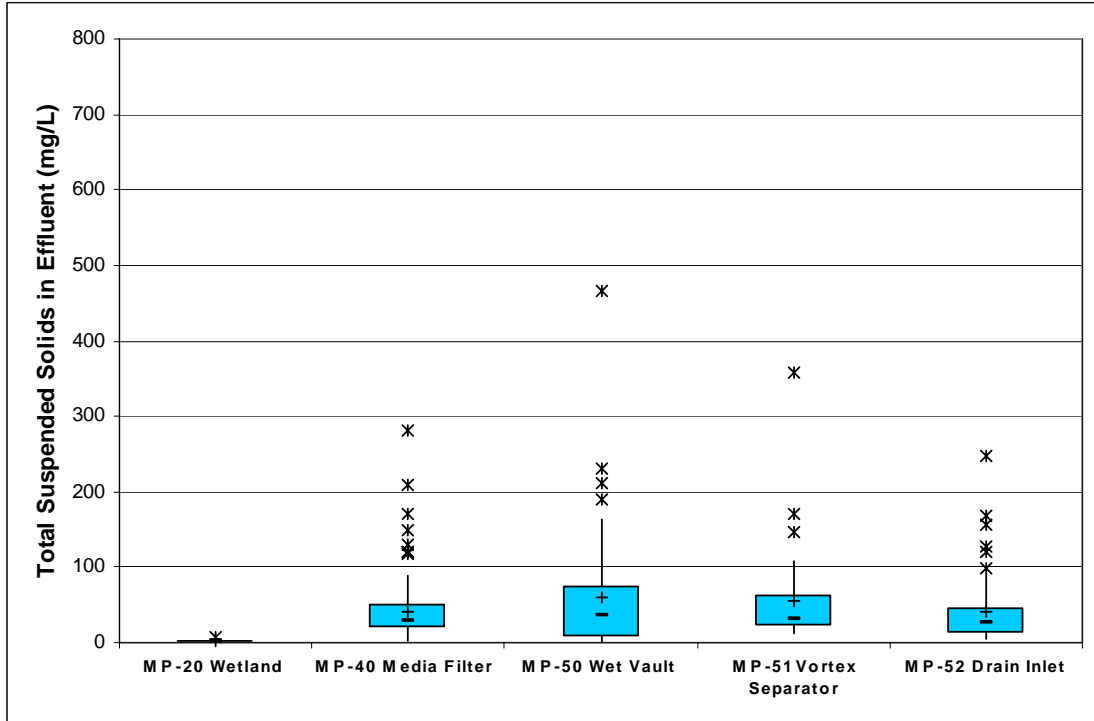

Figure 5-9  
Total Suspended Solids in Effluent

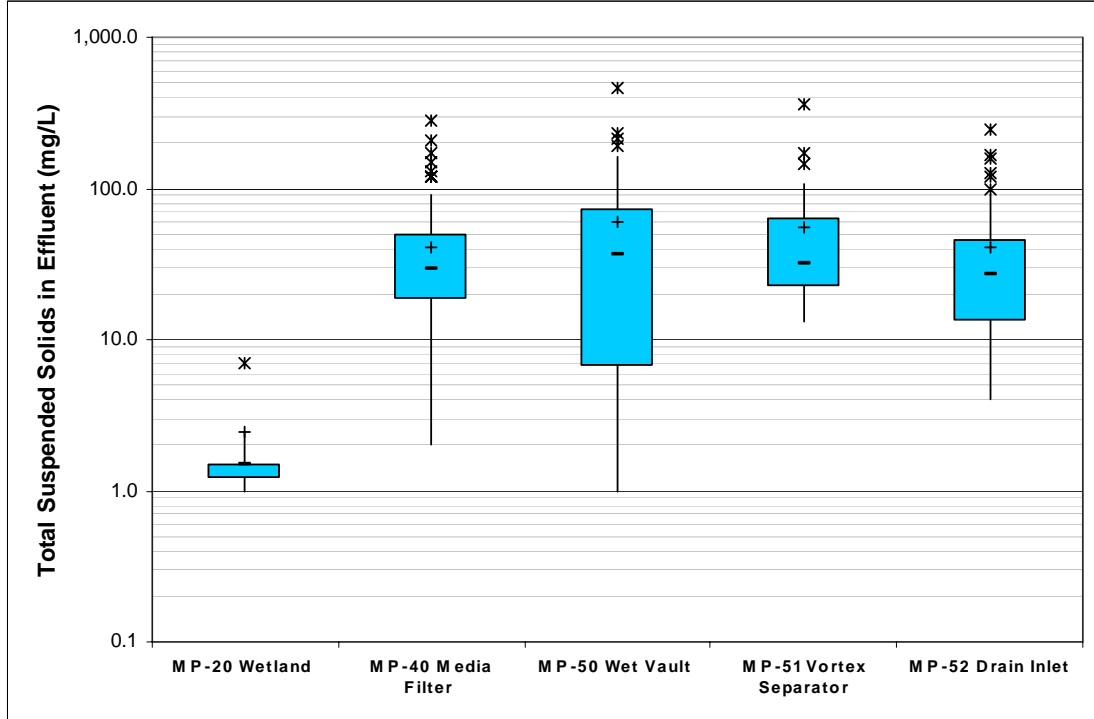

Figure 5-10  
Total Suspended Solids in Effluent (log-format)

As noted earlier, performance of particular products in a grouping may be due to different design criteria within the group. For example, wet vault products differ with respect to the volume of the permanent wet pool to the design event volume; filter products differ with respect to the type of media.

### 5.4.5 Technology Certification

This Handbook does not endorse proprietary products, although many are described. It is left to each community to determine which proprietary products may be used, and under what circumstances. When considering a proprietary product, it is strongly advised that the community consider performance data, but only performance data that have been collected following a widely accepted protocol. Protocols have been developed by the American Society of Civil Engineering (ASCE BMP Data Base Program), and by the U.S. Environmental Protection Agency (Environmental Technology Certification Program). The local jurisdiction should ask the manufacturer of the product to submit a report that describes the product and protocol that was followed to produce the performance data.

It can be expected that subsequent to the publishing of this Handbook, new public-domain technologies will be proposed (or design criteria for existing technologies will be altered) by development engineers. As with proprietary products, it is advised that new public-domain technologies be considered only if performance data are available and have been collected following a widely accepted protocol.

## 5.5 BMP Design Criteria for Flow and Volume

Many municipal stormwater discharge permits in California contain provisions such as Standard Urban Stormwater Mitigation Plans, Stormwater Quality Urban Impact Mitigation Plans, or Provision C.3 New and Redevelopment Performance Standards, commonly referred to as SUSMPs, SQUIMPs, or C.3 Provisions, respectively. What these and similar provisions have in common is that they require many new development and redevelopment projects to capture and then infiltrate or treat runoff from the project site prior to being discharged to storm drains. These provisions include minimum standards for sizing these treatment control BMPs. Sizing standards are prescribed for both volume-based and flow-based BMPs.

A key point to consider when developing, reviewing, or complying with requirements for the sizing of treatment control BMPs for stormwater quality enhancement is that BMPs are most efficient and economical when they target small, frequent storm events that over time produce more total runoff than the larger, infrequent storms targeted for design of flood control facilities. The reason for this can be seen by examination of Figure 5-11 and Figure 5-12.

Figure 5-11 shows the distribution of storm events at San Jose, California where most storms produce less than 0.50 in. of total rainfall. Figure 5-12 shows the distribution of rainfall intensities at San Jose, California, where most storms have intensities of less than 0.25 in./hr. The patterns at San Jose, California are typical of other locations throughout the state. Figures 5-11 and 5-12 show that as storm sizes increase, the number of events decrease. Therefore, when BMPs are designed for increasingly larger storms (for example, storms up to 1 in. versus storms of up to 0.5 in.), the BMP size and cost increase dramatically, while the number of additional

treated storm events are small. Table 5-2 shows that doubling the design storm depth from 0.50 in. to 1.00 in. only increases the number of events captured by 23%. Similarly, doubling the design rainfall intensity from 0.25 in/hr to 0.50 in/hr only increases the number of events captured by 7%.

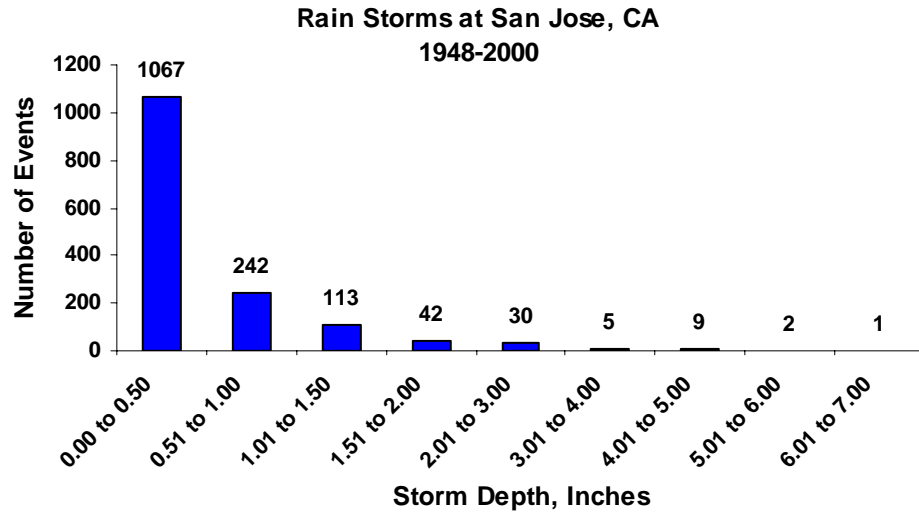

Figure 5-11  
Rain Storms at San Jose, CA

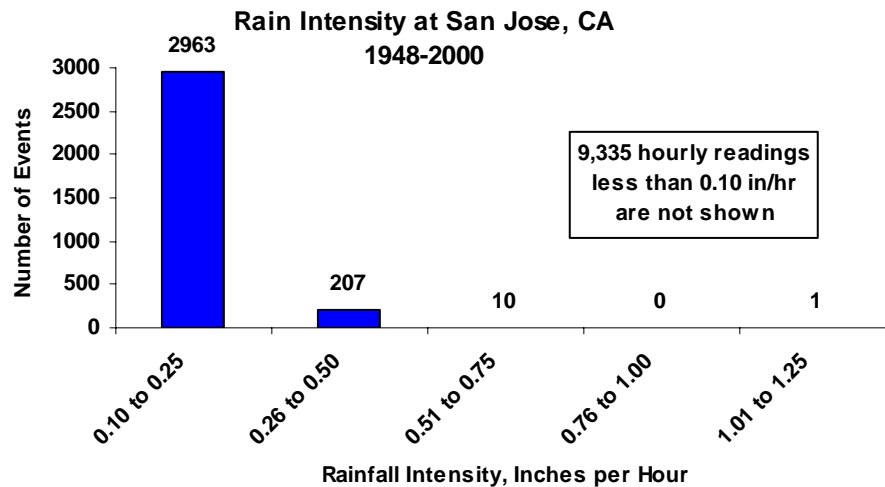
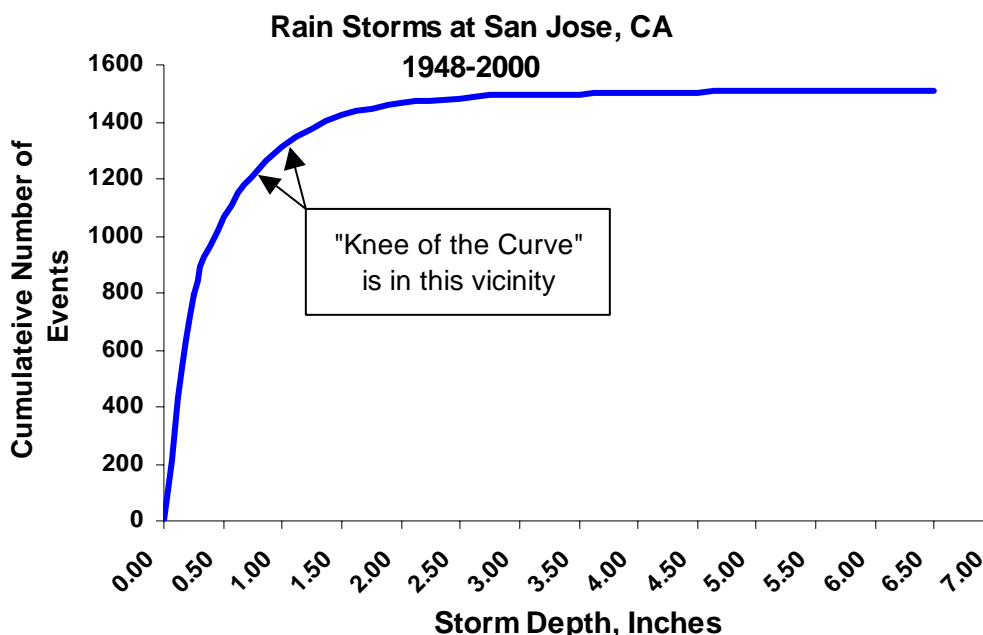

Figure 5-12  
Rain Intensity at San Jose, CA

<b>Proposed BMP Design Target</b>	<b>Number of Historical Events in Range</b>	<b>Incremental Increase in Design Criteria</b>	<b>Incremental Increase in Storms Treated</b>
Storm Depth 0.00 to 0.50 in.	1,067	+100%	+23%
Storm Depth 0.51 to 1.00 in.	242		
Rainfall Intensity 0.10 to 0.25 in/hr	2,963	+100%	+7%
Rainfall Intensity 0.26 to 0.50 in/hr	207		

Due to economies of scale, doubling the capture and treatment requirements for a BMP are not likely to double the cost of many BMPs, but the incremental cost per event will increase, making increases beyond a certain point generally unattractive. Typically, design criteria for water quality control BMPs are set to coincide with the “knee of the curve,” that is, the point of inflection where the magnitude of the event increases more rapidly than number of events captured. Figure 5-13 shows that the “knee of the curve” or point of diminishing returns for San Jose, California is in the range of 0.75 to 1.00 in. of rainfall. In other words, targeting design storms larger than this will produce gains at considerable incremental cost. Similar curves can be developed for rainfall intensity and runoff volume.



**Figure 5-13**  
**Rain Storms at San Jose, CA**

It is important to note that arbitrarily targeting large, infrequent storm events can actually reduce the pollutant removal capabilities of some BMPs. This occurs when outlet structures, detention times, and drain down times are designed to accommodate unusually large volumes and high flows. When BMPs are over-designed, the more frequent, small storms that produce the most annual runoff pass quickly through the over-sized BMPs and therefore receive inadequate treatment. For example, a detention basin might normally be designed to capture 0.5 in. of runoff and to release that runoff over 48 hrs, providing a high level of sediment removal. If the basin were to be oversized to capture 1.0 in. of runoff and to release that runoff over 48 hrs, a more common 0.5 inch runoff event entering basin would drain in approximately 24 hrs, meaning the smaller, more frequent storm that is responsible for more total runoff would receive less treatment than if the basin were designed for the smaller event. Therefore, efficient and economical BMP sizing criteria are usually based on design criteria that correspond to the “knee of the curve” or point of diminishing returns.

### 5.5.1 Volume-Based BMP Design

Volume-based BMP design standards apply to BMPs whose primary mode of pollutant removal depends on the volumetric capacity of the BMP. Examples of BMPs in this category include detention basins, retention basins, and infiltration. Typically, a volume-based BMP design criteria calls for the capture and infiltration or treatment of a certain percentage of the runoff from the project site, usually in the range of the 75th to 85th percentile average annual runoff volume. The 75th to 85th percentile capture range corresponds to the “knee of the curve” for many sites in California for sites whose composite runoff coefficient is in the 0.50 to 0.95 range.

The following are examples of volume-based BMP design standards from current municipal stormwater permits. The permits require that volume-based BMPs be designed to capture and then to infiltrate or treat stormwater runoff equal to one of the following:

- Eighty (80) percent of the volume of annual runoff, determined in accordance with the methodology set forth in Appendix D of the California Storm Water Best Management Practices Handbook (Stormwater Quality Task Force, 1993), using local rainfall data.
- The maximized stormwater quality capture volume for the area, based on historical rainfall records, determined using the formula and volume capture coefficients set forth in Urban Runoff Quality Management (WEF Manual of Practice No. 23/ASCE Manual of Practice No. 87, (1998), pages 175-178).

The reader is referred to the municipal stormwater program manager for the jurisdiction processing the new development or redevelopment project application to determine the specific requirements applicable to a proposed project.

### California Stormwater BMP Handbook Approach

The volume-based BMP sizing methodology included in the first edition of the *California Storm Water Best Management Practice Handbook* (Stormwater Quality Task Force, 1993) has been included in this second edition of the handbook and is the method recommended for use.

The California Stormwater BMP Handbook approach is based on results of a continuous simulation model, the STORM model, developed by the Hydrologic Engineering Center of the U.S. Army Corps of Engineers (COE-HEC, 1977). The Storage, Treatment, Overflow, Runoff Model (STORM) was applied to long-term hourly rainfall data at numerous sites throughout California, with sites selected throughout the state representing a wide range of municipal stormwater permit areas, climatic areas, geography, and topography. STORM translates rainfall into runoff, then routes the runoff through detention storage. The volume-based BMP sizing curves resulting from the STORM model provide a range of options for choosing a BMP sizing curve appropriate to sites in most areas of the state. The volume-based BMP sizing curves are included in Appendix D. Key model assumptions are also documented in Appendix D.

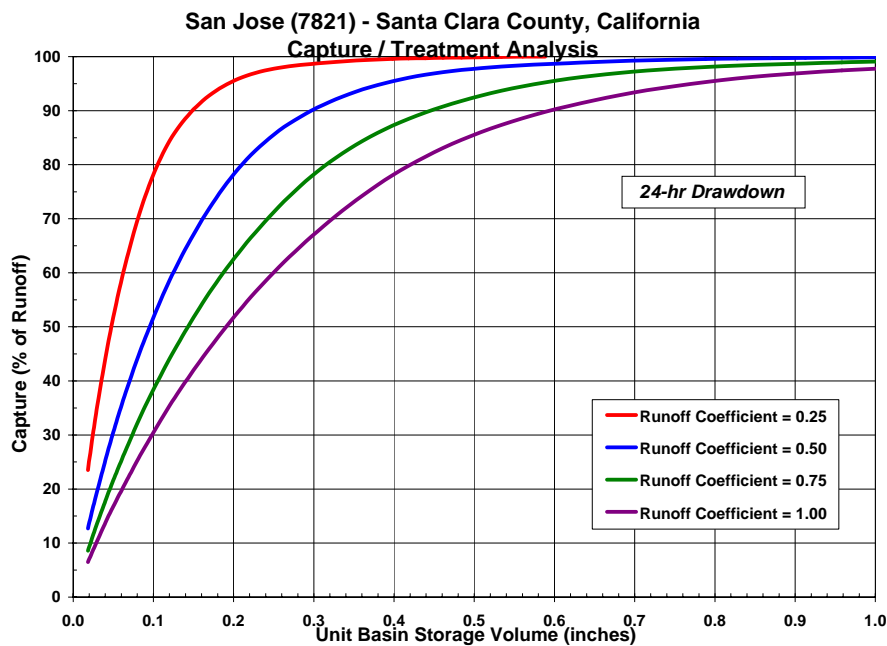

**Figure 5-14**  
**Capture/Treatment Analysis at San Jose, CA**

The California Stormwater BMP Handbook approach is simple to apply, and relies largely on commonly available information about a project. The following steps describe the use of the BMP sizing curves contained in Appendix D.

1. Identify the “BMP Drainage Area” that drains to the proposed BMP. This includes all areas that will contribute runoff to the proposed BMP, including pervious areas, impervious areas, and off-site areas, whether or not they are directly or indirectly connected to the BMP.
2. Calculate the composite runoff coefficient “C” for the area identified in Step 1.
3. Select a capture curve representative of the site and the desired drain down time using Appendix D. Curves are presented for 24-hour and 48-hour draw down times. The 48-hour curve should be used in most areas of California. Use of the 24-hour curve should be limited

to drainage areas with coarse soils that readily settle and to watersheds where warming may be detrimental to downstream fisheries. Draw down times in excess of 48 hours should be used with caution, as vector breeding can be a problem after water has stood in excess of 72 hours.

4. Determine the applicable requirement for capture of runoff (Capture, % of Runoff).
5. Enter the capture curve selected in Step 3 on the vertical axis at the “Capture, % Runoff” value identified in Step 4. Move horizontally to the right across capture curve until the curve corresponding to the drainage area’s composite runoff coefficient “C” determined in Step 2 is intercepted. Interpolation between curves may be necessary. Move vertically down from this point until the horizontal axis is intercepted. Read the “Unit Basin Storage Volume” along the horizontal axis. If a local requirement for capture of runoff is not specified, enter the vertical axis at the “knee of the curve” for the curve representing composite runoff coefficient “C.” The “knee of the curve” is typically in the range of 75 to 85% capture.
6. Calculate the required capture volume of the BMP by multiplying the “BMP Drainage Area” from Step 1 by the “Unit Basin Storage Volume” from Step 5 to give the BMP volume. Due to the mixed units that result (e.g., ac-in., ac-ft) it is recommended that the resulting volume be converted to cubic feet for use during design.

### **Urban Runoff Quality Management Approach**

The volume-based BMP sizing methodology described in *Urban Runoff Quality Management* (WEF Manual of Practice No. 23/ASCE Manual of Practice No. 87, (1998), pages 175-178) has been included in this edition of the handbook as an alternative to the California Stormwater BMP Handbook approach described above. The Urban Runoff Quality Management Approach is suitable for planning level estimates of the size of volume-based BMPs (WEF/ASCE, 1998, page 175).

The Urban Runoff Quality Management approach is similar to the California Stormwater BMP Handbook approach in that it is based on the translation of rainfall to runoff. The Urban Runoff Quality Management approach is based on two regression equations. The first regression equation relates rainfall to runoff. The rainfall to runoff regression equation was developed using 2 years of data from more than 60 urban watersheds nationwide. The second regression equation relates mean annual runoff-producing rainfall depths to the “Maximized Water Quality Capture Volume” which corresponds to the “knee of the cumulative probability curve”. This second regression was based on analysis of long-term rainfall data from seven rain gages representing climatic zones across the country. The Maximized Water Quality Capture Volume corresponds to approximately the 85th percentile runoff event, and ranges from 82 to 88%.

The two regression equations that form the Urban Runoff Quality Management approach are as follows:

$$C = 0.858I^3 - 0.78I^2 + 0.774I + 0.04$$

$$P_0 = (a \cdot C) \cdot P_6$$

Where

$C$  = runoff coefficient

$i$  = watershed imperviousness ratio which is equal to the percent total imperviousness divided by 100

$P_0$  = Maximized Detention Volume, in watershed inches

$a$  = regression constant,  $a=1.582$  and  $a=1.963$  for 24 and 48 hour draw down, respectively

$P_6$  = mean annual runoff-producing rainfall depths, in watershed inches, Table #-1. See Appendix D.

The Urban Runoff Quality Management Approach is simple to apply. The following steps describe the use of the approach.

1. Identify the “BMP Drainage Area” that drains to the proposed BMP. This includes all areas that will contribute runoff to the proposed BMP, including pervious areas, impervious areas, and off-site areas, whether or not they are directly or indirectly connected to the BMP.
2. Calculate the “Watershed Imperviousness Ratio” ( $i$ ), which is equal to the percent of total impervious area in the “BMP Drainage Area” divided by 100.
3. Calculate the “Runoff Coefficient” ( $C$ ) using the following equation:

$$C = 0.858i^3 - 0.78i^2 + 0.774i + 0.04$$

4. Determine the “Mean Annual Runoff” ( $P_6$ ) for the “BMP Drainage Area” using Table #-1 in Appendix D.
5. Determine the “Regression Constant” ( $a$ ) for the desired BMP drain down time. Use  $a=1.582$  for 24 hrs and  $a=1.963$  for 48 hr draw down.
6. Calculate the “Maximized Detention Volume” ( $P_0$ ) using the following equation:

$$P_0 = (a \cdot C) \cdot P_6$$

7. Calculate the required capture volume of the BMP by multiplying the “BMP Drainage Area” from Step 1 by the “Maximized Detention Volume” from Step 6 to give the BMP volume. Due to the mixed units that result (e.g., ac-in., ac-ft) it is recommended that the resulting volume be converted to  $\text{ft}^3$  for use during design.

### 5.5.2 Flow-Based BMP Design

Flow-based BMP design standards apply to BMPs whose primary mode of pollutant removal depends on the rate of flow of runoff through the BMP. Examples of BMPs in this category



include swales, sand filters, screening devices, and many proprietary products. Typically, a flow-based BMP design criteria calls for the capture and infiltration or treatment of the flow runoff produced by rain events of a specified magnitude.

The following are examples of flow-based BMP design standards from current municipal stormwater permits. The permits require that flow-based BMPs be designed to capture and then to infiltrate or treat stormwater runoff equal to one of the following:

- 10% of the 50-yr peak flow rate (Factored Flood Flow Approach)
- The flow of runoff produced by a rain event equal to at least two times the 85th percentile hourly rainfall intensity for the applicable area, based on historical records of hourly rainfall depths (California Stormwater BMP Handbook Approach)
- The flow of runoff resulting from a rain event equal to at least 0.2 in/hr intensity (Uniform Intensity Approach)

The reader is referred to the municipal stormwater program manager for the jurisdiction processing the new development or redevelopment project application to determine the specific requirements applicable to a proposed project.

The three typical requirements shown above all have in common a rainfall intensity element. That is, each criteria is based treating a flow of runoff produced by a rain event of specified rainfall intensity.

In the first example, the Factored Flood Flow Approach, the design rainfall intensity is a function of the location and time of concentration of the area discharging to the BMP. The intensity in this case is determined using Intensity-Duration-Frequency curves published by the flood control agency with jurisdiction over the project or available from climatic data centers. This approach is simple to apply when the 50-yr peak flow has already been determined for either drainage system design or flood control calculations.

In the second example, the California Stormwater BMP Handbook Approach (so called because it is recommended in this handbook), the rainfall intensity is a function of the location of the area discharging to the BMP. The intensity in this case can be determined using the rain intensity cumulative frequency curves developed for this Handbook based on analysis of long-term hourly rainfall data at numerous sites throughout California, with sites selected throughout the state representing a wide range of municipal stormwater permit areas, climatic areas, geography, and topography. These rain intensity cumulative frequency curves are included in Appendix D. This approach is recommended as it reflects local conditions throughout the state. The flow-based design criteria in some municipal permits require design based on two times the 85<sup>th</sup> percentile hourly rainfall intensity. The factor of two included in these permits appears to be provided as a factor of safety: therefore, caution should be exercised when applying additional factors of safety during the design process so that over design can be avoided.

In the third example, the Uniform Intensity Approach, the rainfall intensity is specified directly, and is not a function of the location or time of concentration of the area draining to the BMP. This approach is very simple to apply, but it is not reflective of local conditions.

The three example flow-based BMP design criteria are easy to apply and can be used in conjunction with the Rational Formula, a simplified, easy to apply formula that predicts flow rates based on rainfall intensity and drainage area characteristics. The Rational Formula is as follows:

$$Q = CiA$$

where

Q = flow in ft<sup>3</sup>/s

i = rain intensity in in/hr

A = drainage area in acres

C = runoff coefficient

The Rational Formula is widely used for hydrologic calculations, but it does have a number of limitations. For stormwater BMP design, a key limitation is the ability of the Rational Formula to predict runoff from undeveloped areas where runoff coefficients are highly variable with storm intensity and antecedent moisture conditions. This limitation is accentuated when predicting runoff from frequent, small storms used in stormwater quality BMP design because many of the runoff coefficients in common use were developed for predicting runoff for drainage design where larger, infrequent storms are of interest. Table 5-3 provides some general guidelines on use of the Rational Equation.

<b>BMP Drainage Area (Acres)</b>	<b>Composite Runoff Coefficient, "C"</b>			
	<b>0.00 to 0.25</b>	<b>0.26 to 0.50</b>	<b>0.51 to 0.75</b>	<b>0.76 to 1.00</b>
0 to 25	Caution	Yes	Yes	Yes
26 to 50	High Caution	Caution	Yes	Yes
51 to 75	Not Recommended	High Caution	Caution	Yes
76 to 100	Not Recommended	High Caution	Caution	Yes

In summary, the Rational Formula, when used with commonly tabulated runoff coefficients in undeveloped drainage areas, will likely result in predictions higher than will be experienced under actual field conditions. However, given the simplicity of the equation, its use remains

practical and is often the standard method specified by local agencies. In general, use of alternative formulas for predicting BMP design flows based on the intensity criteria above is acceptable if the formula is approved by the local flood control agency or jurisdiction where the project is being developed.

The following steps describe the approach for application of the flow-based BMP design criteria:

1. Identify the “BMP Drainage Area” that drains to the proposed BMP. This includes all areas that will contribute runoff to the proposed BMP, including pervious areas, impervious areas, and off-site areas, whether or not they are directly or indirectly connected to the BMP.
2. Determine rainfall intensity criteria to apply and the corresponding design rainfall intensity.
  - a. *Factored Flood Flow Approach:* Determine the time of concentration for “BMP Drainage Area” using procedures approved by the local flood control agency or using standard hydrology methods. Identify an Intensity-Duration-Frequency Curve representative of the drainage area (usually available from the local flood control agency or climatic data center). Enter the Intensity-Duration-Frequency Curve with the time of concentration and read the rainfall intensity corresponding to the 50-yr return period rainfall event. This intensity is the “Design Rainfall Intensity.”
  - b. *California Stormwater BMP Handbook Approach:* Select a rain intensity cumulative frequency curve representative of the “BMP Drainage Area.” See Appendix D. Read the rainfall intensity corresponding to the cumulative probability specified in the criteria, usually 85%. Multiply the intensity by the safety factor specified in the criteria, usually 2, to get the “Design Rainfall Intensity.”
  - c. *Uniform Intensity Approach:* The “Design Rainfall Intensity” is the intensity specified in the criteria, usually 0.2 in/hr.
3. Calculate the composite runoff coefficient “C” for the “BMP Drainage Area” identified in Step 1.
4. Apply the Rational Formula to calculate the “BMP Design Flow”
  - a. *Factored Flood Flow Approach:* Using the “BMP Drainage Area” from Step 1, the “Design Rainfall Intensity” from Step 2a, and “C” from Step 3, apply the Rational Formula and multiply the result by 0.1. The result is the “BMP Design Flow.”
  - b. *California Stormwater BMP Handbook Approach:* Using the “BMP Drainage Area” from Step 1, the “Design Rainfall Intensity” from Step 2b, and “C” from Step 3, apply the Rational Formula. The result is the “BMP Design Flow.”
  - c. *Uniform Intensity Approach:* Using the “BMP Drainage Area” from Step 1, the “Design Rainfall Intensity” from Step 2c, and “C” from Step 3, apply the Rational Formula. The result is the “BMP Design Flow.”

### 5.5.3 Combined Volume-Based and Flow-Based BMP Design

Volume-based BMPs and flow-based BMPs do not necessarily treat precisely the same stormwater runoff. For example, an on-line volume-based BMP such as a detention basin will treat the design runoff volume and is essentially unaffected by runoff entering the basin at an extremely high rate, say from a very short, but intense storm that produces the design volume of runoff. However, a flow-based BMP might be overwhelmed by the same short, but intense storm if the storm intensity results in runoff rates that exceed the flow-based BMP design flow rate. By contrast, a flow-based BMP such as a swale will treat the design flow rate of runoff and is essentially unaffected by the duration of the design flow, say from a long, low intensity storm. However, a volume-based detention basin subjected to this same rainfall and runoff event will begin to provide less treatment or will go into bypass or overflow mode after the design runoff volume is delivered.

Therefore, there may be some situations where designers need to consider both volume-based and flow-based BMP design criteria. An example of where both types of criteria might apply is an off-line detention basin. For an off-line detention basin, the capacity of the diversion structure could be designed to comply with the flow-based BMP design criteria while the detention basin itself could be designed to comply with the volume-based criteria.

When both volume-based and flow based criteria apply, the designer should determine which of the criteria apply to each element of the BMP system, and then size the elements accordingly.

## 5.6 Other BMP Selection Factors

Other factors that influence the selection of BMPs include cost, vector control issues, and endangered species issues. Each of these is discussed briefly below.

### 5.6.1 Costs

The relative costs for implementing various public domain and manufactured BMPs based on flow and volume parameters are shown in Tables 5-4 and 5-5 below:

<b>BMP</b>	<b>Cost/cfs</b>
Strip	\$\$
Swale	\$\$
Wet Vault	Not available
Media Filter	\$\$\$\$
Vortex	Not available
Drain Insert	Not available

<b>BMP</b>	<b>Cost/acre-ft</b>
Austin Sand Filter Basin	\$\$\$\$
Delaware Lineal Sand Filter	\$\$\$\$
Extended Detention Basin (EDB)	\$\$
Multi Chamber Treatment Train (MCTT)	\$\$\$\$
Wet Basin	\$\$\$\$
Manufactured Wetland	Not available
Infiltration Basin	\$
Wet Pond and Constructed Wetland	\$\$\$\$

### 5.6.2 Vector Breeding Considerations

The potential of a BMP to create vector breeding habitat and/or harborage should be considered when selecting BMPs. Mosquito and other vector production is a nuisance and public health threat. Mosquitoes can breed in standing water almost immediately following a BMP installation and may persist at unnaturally high levels and for longer seasonal periods in created habitats. BMP siting, design, construction, and maintenance must be considered in order to select a BMP that is least conducive to providing habitat for vectors. Tips for minimizing vector-breeding problems in the design and maintenance of BMPs are presented in the BMP fact sheets. Certain BMPs, including ponds and wetlands and those designed with permanent water sumps, vaults, and/or catch basins (including below ground installations), may require routine inspections and treatments by local mosquito and vector control agencies to suppress vector production.

### 5.6.3 Threatened and Endangered Species Considerations

The presence or potential presence of threatened and endangered species should also be considered when selecting BMPs. Although preservation of threatened endangered species is crucial, treatment BMPs are not intended to supplement or replace species habitat except under special circumstances. The presence of threatened or endangered species can hinder timely and routine maintenance, which in turn can result in reduced BMP performance and an increase in vector production. In extreme cases, jurisdictional rights to the treatment BMP and surrounding land may be lost if threatened or endangered species utilize or become established in the BMP.

When considering BMPs where there is a presence or potential presence of threatened or endangered species, early coordination with the California Department of Fish and Game and the U.S. Fish and Wildlife service is essential. During this coordination, the purpose and the long-term operation and maintenance requirements of the BMPs need to be clearly established through written agreements or memorandums of understanding. Absent firm agreements or understandings, proceeding with BMPs under these circumstances is not recommended.

## 5.7 BMP Fact Sheets

BMP fact sheets for public domain and manufactured BMPs follow. The BMP fact sheets are individually page numbered and are suitable for photocopying and inclusion in stormwater quality management plans. Fresh copies of the fact sheets can be individually downloaded from the Caltrans Stormwater BMP Handbook website at [www.cabmphandbooks.com](http://www.cabmphandbooks.com).





## Design Considerations

- Accumulation of Metals
- Clogged Soil Outlet Structures
- Vegetation/Landscape Maintenance

## Description

An infiltration trench is a long, narrow, rock-filled trench with no outlet that receives stormwater runoff. Runoff is stored in the void space between the stones and infiltrates through the bottom and into the soil matrix. Infiltration trenches perform well for removal of fine sediment and associated pollutants.

Pretreatment using buffer strips, swales, or detention basins is important for limiting amounts of coarse sediment entering the trench which can clog and render the trench ineffective.

## California Experience

Caltrans constructed two infiltration trenches at highway maintenance stations in Southern California. Of these, one failed to operate to the design standard because of average soil infiltration rates lower than that measured in the single infiltration test. This highlights the critical need for appropriate evaluation of the site. Once in operation, little maintenance was required at either site.

## Advantages

- Provides 100% reduction in the load discharged to surface waters.
- An important benefit of infiltration trenches is the approximation of pre-development hydrology during which a significant portion of the average annual rainfall runoff is infiltrated rather than flushed directly to creeks.
- If the water quality volume is adequately sized, infiltration trenches can be useful for providing control of channel forming (erosion) and high frequency (generally less than the 2-year) flood events.

## Targeted Constituents

<input checked="" type="checkbox"/>	Sediment	■
<input checked="" type="checkbox"/>	Nutrients	■
<input checked="" type="checkbox"/>	Trash	■
<input checked="" type="checkbox"/>	Metals	■
<input checked="" type="checkbox"/>	Bacteria	■
<input checked="" type="checkbox"/>	Oil and Grease	■
<input checked="" type="checkbox"/>	Organics	■

### Legend (Removal Effectiveness)

- Low
- High
- ▲ Medium



- As an underground BMP, trenches are unobtrusive and have little impact of site aesthetics.

## Limitations

- Have a high failure rate if soil and subsurface conditions are not suitable.
- May not be appropriate for industrial sites or locations where spills may occur.
- The maximum contributing area to an individual infiltration practice should generally be less than 5 acres.
- Infiltration basins require a minimum soil infiltration rate of 0.5 inches/hour, not appropriate at sites with Hydrologic Soil Types C and D.
- If infiltration rates exceed 2.4 inches/hour, then the runoff should be fully treated prior to infiltration to protect groundwater quality.
- Not suitable on fill sites or steep slopes.
- Risk of groundwater contamination in very coarse soils.
- Upstream drainage area must be completely stabilized before construction.
- Difficult to restore functioning of infiltration trenches once clogged.

## Design and Sizing Guidelines

- Provide pretreatment for infiltration trenches in order to reduce the sediment load. Pretreatment refers to design features that provide settling of large particles before runoff reaches a management practice, easing the long-term maintenance burden. Pretreatment is important for all structural stormwater management practices, but it is particularly important for infiltration practices. To ensure that pretreatment mechanisms are effective, designers should incorporate practices such as grassed swales, vegetated filter strips, detention, or a plunge pool in series.
- Specify locally available trench rock that is 1.5 to 2.5 inches in diameter.
- Determine the trench volume by assuming the WQV will fill the void space based on the computed porosity of the rock matrix (normally about 35%).
- Determine the bottom surface area needed to drain the trench within 72 hr by dividing the WQV by the infiltration rate.

$$d = \frac{WQV + RFV}{SA}$$

- Calculate trench depth using the following equation:

where:

D = Trench depth



WQV	=	Water quality volume
RFV	=	Rock fill volume
SA	=	Surface area of the trench bottom

- The use of vertical piping, either for distribution or infiltration enhancement shall not be allowed to avoid device classification as a Class V injection well per 40 CFR146.5(e)(4).
- Provide observation well to allow observation of drain time.
- May include a horizontal layer of filter fabric just below the surface of the trench to retain sediment and reduce the potential for clogging.

### ***Construction/Inspection Considerations***

Stabilize the entire area draining to the facility before construction begins. If impossible, place a diversion berm around the perimeter of the infiltration site to prevent sediment entrance during construction. Stabilize the entire contributing drainage area before allowing any runoff to enter once construction is complete.

### **Performance**

Infiltration trenches eliminate the discharge of the water quality volume to surface receiving waters and consequently can be considered to have 100% removal of all pollutants within this volume. Transport of some of these constituents to groundwater is likely, although the attenuation in the soil and subsurface layers will be substantial for many constituents.

Infiltration trenches can be expected to remove up to 90 percent of sediments, metals, coliform bacteria and organic matter, and up to 60 percent of phosphorus and nitrogen in the infiltrated runoff (Schueler, 1992). Biochemical oxygen demand (BOD) removal is estimated to be between 70 to 80 percent. Lower removal rates for nitrate, chlorides and soluble metals should be expected, especially in sandy soils (Schueler, 1992). Pollutant removal efficiencies may be improved by using washed aggregate and adding organic matter and loam to the subsoil. The stone aggregate should be washed to remove dirt and fines before placement in the trench. The addition of organic material and loam to the trench subsoil may enhance metals removal through adsorption.

### **Siting Criteria**

The use of infiltration trenches may be limited by a number of factors, including type of native soils, climate, and location of groundwater table. Site characteristics, such as excessive slope of the drainage area, fine-grained soil types, and proximate location of the water table and bedrock, may preclude the use of infiltration trenches. Generally, infiltration trenches are not suitable for areas with relatively impermeable soils containing clay and silt or in areas with fill.

As with any infiltration BMP, the potential for groundwater contamination must be carefully considered, especially if the groundwater is used for human consumption or agricultural purposes. The infiltration trench is not suitable for sites that use or store chemicals or hazardous materials unless hazardous and toxic materials are prevented from entering the trench. In these areas, other BMPs that do not allow interaction with the groundwater should be considered.

The potential for spills can be minimized by aggressive pollution prevention measures. Many municipalities and industries have developed comprehensive spill prevention control and countermeasure (SPCC) plans. These plans should be modified to include the infiltration trench and the contributing drainage area. For example, diversion structures can be used to prevent spills from entering the infiltration trench. Because of the potential to contaminate groundwater, extensive site investigation must be undertaken early in the site planning process to establish site suitability for the installation of an infiltration trench.

Longevity can be increased by careful geotechnical evaluation prior to construction and by designing and implementing an inspection and maintenance plan. Soil infiltration rates and the water table depth should be evaluated to ensure that conditions are satisfactory for proper operation of an infiltration trench. Pretreatment structures, such as a vegetated buffer strip or water quality inlet, can increase longevity by removing sediments, hydrocarbons, and other materials that may clog the trench. Regular maintenance, including the replacement of clogged aggregate, will also increase the effectiveness and life of the trench.

Evaluation of the viability of a particular site is the same as for infiltration basins and includes:

- Determine soil type (consider RCS soil type 'A, B or C' only) from mapping and consult USDA soil survey tables to review other parameters such as the amount of silt and clay, presence of a restrictive layer or seasonal high water table, and estimated permeability. The soil should not have more than 30 percent clay or more than 40 percent of clay and silt combined. Eliminate sites that are clearly unsuitable for infiltration.
- Groundwater separation should be at least 3 m from the basin invert to the measured ground water elevation. There is concern at the state and regional levels of the impact on groundwater quality from infiltrated runoff, especially when the separation between groundwater and the surface is small.
- Location away from buildings, slopes and highway pavement (greater than 6 m) and wells and bridge structures (greater than 30 m). Sites constructed of fill, having a base flow or with a slope greater than 15 percent should not be considered.
- Ensure that adequate head is available to operate flow splitter structures (to allow the basin to be offline) without ponding in the splitter structure or creating backwater upstream of the splitter.
- Base flow should not be present in the tributary watershed.

#### ***Secondary Screening Based on Site Geotechnical Investigation***

- At least three in-hole conductivity tests shall be performed using USBR 7300-89 or Bouwer-Rice procedures (the latter if groundwater is encountered within the boring), two tests at different locations within the proposed basin and the third down gradient by no more than approximately 10 m. The tests shall measure permeability in the side slopes and the bed within a depth of 3 m of the invert.
- The minimum acceptable hydraulic conductivity as measured in any of the three required test holes is 13 mm/hr. If any test hole shows less than the minimum value, the site should be disqualified from further consideration.

- Exclude from consideration sites constructed in fill or partially in fill unless no silts or clays are present in the soil boring. Fill tends to be compacted, with clays in a dispersed rather than flocculated state, greatly reducing permeability.
- The geotechnical investigation should be such that a good understanding is gained as to how the stormwater runoff will move in the soil (horizontally or vertically) and if there are any geological conditions that could inhibit the movement of water.

## Maintenance

Infiltration trenches required the least maintenance of any of the BMPs evaluated in the Caltrans study, with approximately 17 field hours spent on the operation and maintenance of each site. Inspection of the infiltration trench was the largest field activity, requiring approximately 8 hr/yr.

In addition to reduced water quality performance, clogged infiltration trenches with surface standing water can become a nuisance due to mosquito breeding. If the trench takes more than 72 hours to drain, then the rock fill should be removed and all dimensions of the trench should be increased by 2 inches to provide a fresh surface for infiltration.

## Cost

### **Construction Cost**

Infiltration trenches are somewhat expensive, when compared to other stormwater practices, in terms of cost per area treated. Typical construction costs, including contingency and design costs, are about \$5 per ft<sup>3</sup> of stormwater treated (SWRPC, 1991; Brown and Schueler, 1997). Actual construction costs may be much higher. The average construction cost of two infiltration trenches installed by Caltrans in southern California was about \$50/ft<sup>3</sup>; however, these were constructed as retrofit installations.

Infiltration trenches typically consume about 2 to 3 percent of the site draining to them, which is relatively small. In addition, infiltration trenches can fit into thin, linear areas. Thus, they can generally fit into relatively unusable portions of a site.

### **Maintenance Cost**

One cost concern associated with infiltration practices is the maintenance burden and longevity. If improperly sited or maintained, infiltration trenches have a high failure rate. In general, maintenance costs for infiltration trenches are estimated at between 5 percent and 20 percent of the construction cost. More realistic values are probably closer to the 20-percent range, to ensure long-term functionality of the practice.

## References and Sources of Additional Information

Caltrans, 2002, BMP Retrofit Pilot Program Proposed Final Report, Rpt. CTSW-RT-01-050, California Dept. of Transportation, Sacramento, CA.

Brown, W., and T. Schueler. 1997. *The Economics of Stormwater BMPs in the Mid-Atlantic Region*. Prepared for the Chesapeake Research Consortium, Edgewater, MD, by the Center for Watershed Protection, Ellicott City, MD.

Galli, J. 1992. *Analysis of Urban BMP Performance and Longevity in Prince George's County, Maryland*. Metropolitan Washington Council of Governments, Washington, DC.

Maryland Department of the Environment (MDE). 2000. *Maryland Stormwater Design Manual*. <http://www.mde.state.md.us/environment/wma/stormwatermanual>. Accessed May 22, 2001.

Metzger, M. E., D. F. Messer, C. L. Beitia, C. M. Myers, and V. L. Kramer. 2002. The Dark Side Of Stormwater Runoff Management: Disease Vectors Associated With Structural BMPs. *Stormwater* 3(2): 24-39.

Schueler, T. 1987. *Controlling Urban Runoff: A Practical Manual for Planning and Designing Urban BMPs*. Metropolitan Washington Council of Governments, Washington, DC.

Southeastern Wisconsin Regional Planning Commission (SWRPC). 1991. *Costs of Urban Nonpoint Source Water Pollution Control Measures*. Southeastern Wisconsin Regional Planning Commission, Waukesha, WI.

Watershed Management Institute (WMI). 1997. *Operation, Maintenance, and Management of Stormwater Management Systems*. Prepared for U.S. Environmental Protection Agency, Office of Water, Washington, DC.

#### **Information Resources**

Center for Watershed Protection (CWP). 1997. *Stormwater BMP Design Supplement for Cold Climates*. Prepared for the U.S. Environmental Protection Agency, Office of Wetlands, Oceans and Watersheds, Washington, DC, by the Center for Watershed Protection, Ellicott City, MD.

Ferguson, B.K. 1994. *Stormwater Infiltration*. CRC Press, Ann Arbor, MI.

Minnesota Pollution Control Agency. 1989. *Protecting Water Quality in Urban Areas: Best Management Practices*. Minnesota Pollution Control Agency, Minneapolis, MN.

USEPA. 1993. *Guidance to Specify Management Measures for Sources of Nonpoint Pollution in Coastal Waters*. EPA-840-B-92-002. U.S. Environmental Protection Agency, Office of Water, Washington, DC.

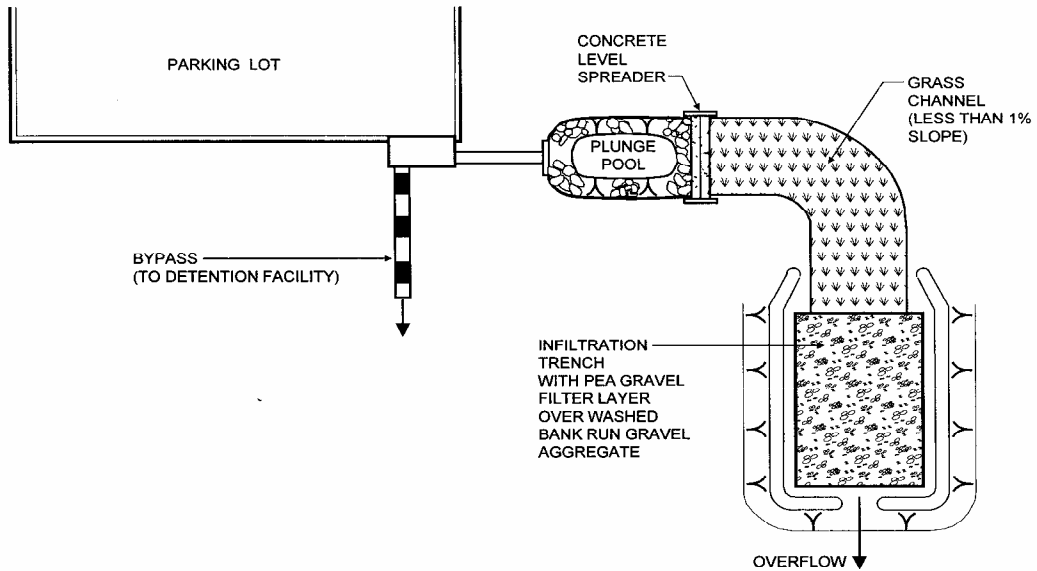

**PLAN VIEW**

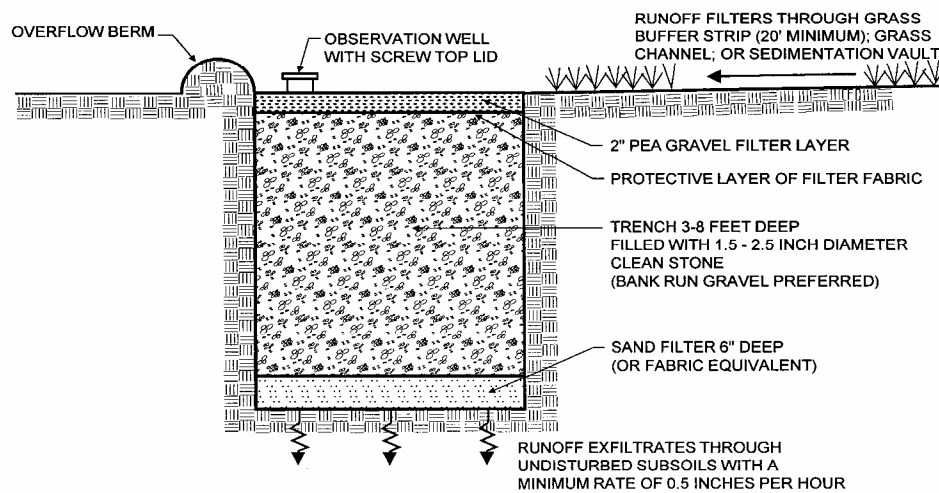

**SECTION**





## Description

An infiltration basin is a shallow impoundment that is designed to infiltrate stormwater. Infiltration basins use the natural filtering ability of the soil to remove pollutants in stormwater runoff. Infiltration facilities store runoff until it gradually exfiltrates through the soil and eventually into the water table. This practice has high pollutant removal efficiency and can also help recharge groundwater, thus helping to maintain low flows in stream systems. Infiltration basins can be challenging to apply on many sites, however, because of soils requirements. In addition, some studies have shown relatively high failure rates compared with other management practices.

## California Experience

Infiltration basins have a long history of use in California, especially in the Central Valley. Basins located in Fresno were among those initially evaluated in the National Urban Runoff Program and were found to be effective at reducing the volume of runoff, while posing little long-term threat to groundwater quality (EPA, 1983; Schroeder, 1995). Proper siting of these devices is crucial as underscored by the experience of Caltrans in siting two basins in Southern California. The basin with marginal separation from groundwater and soil permeability failed immediately and could never be rehabilitated.

## Advantages

- Provides 100% reduction in the load discharged to surface waters.
- The principal benefit of infiltration basins is the approximation of pre-development hydrology during which a

## Design Considerations

- Soil for Infiltration
- Slope
- Aesthetics

## Targeted Constituents

- |                                     |                |   |
|-------------------------------------|----------------|---|
| <input checked="" type="checkbox"/> | Sediment       | ■ |
| <input checked="" type="checkbox"/> | Nutrients      | ■ |
| <input checked="" type="checkbox"/> | Trash          | ■ |
| <input checked="" type="checkbox"/> | Metals         | ■ |
| <input checked="" type="checkbox"/> | Bacteria       | ■ |
| <input checked="" type="checkbox"/> | Oil and Grease | ■ |
| <input checked="" type="checkbox"/> | Organics       | ■ |

Legend (*Removal Effectiveness*)

- |          |        |
|----------|--------|
| ● Low    | ■ High |
| ▲ Medium |        |



significant portion of the average annual rainfall runoff is infiltrated and evaporated rather than flushed directly to creeks.

- If the water quality volume is adequately sized, infiltration basins can be useful for providing control of channel forming (erosion) and high frequency (generally less than the 2-year) flood events.

### **Limitations**

- May not be appropriate for industrial sites or locations where spills may occur.
- Infiltration basins require a minimum soil infiltration rate of 0.5 inches/hour, not appropriate at sites with Hydrologic Soil Types C and D.
- If infiltration rates exceed 2.4 inches/hour, then the runoff should be fully treated prior to infiltration to protect groundwater quality.
- Not suitable on fill sites or steep slopes.
- Risk of groundwater contamination in very coarse soils.
- Upstream drainage area must be completely stabilized before construction.
- Difficult to restore functioning of infiltration basins once clogged.

### **Design and Sizing Guidelines**

- Water quality volume determined by local requirements or sized so that 85% of the annual runoff volume is captured.
- Basin sized so that the entire water quality volume is infiltrated within 48 hours.
- Vegetation establishment on the basin floor may help reduce the clogging rate.

### ***Construction/Inspection Considerations***

- Before construction begins, stabilize the entire area draining to the facility. If impossible, place a diversion berm around the perimeter of the infiltration site to prevent sediment entrance during construction or remove the top 2 inches of soil after the site is stabilized. Stabilize the entire contributing drainage area, including the side slopes, before allowing any runoff to enter once construction is complete.
- Place excavated material such that it can not be washed back into the basin if a storm occurs during construction of the facility.
- Build the basin without driving heavy equipment over the infiltration surface. Any equipment driven on the surface should have extra-wide ("low pressure") tires. Prior to any construction, rope off the infiltration area to stop entrance by unwanted equipment.
- After final grading, till the infiltration surface deeply.
- Use appropriate erosion control seed mix for the specific project and location.



## Performance

As water migrates through porous soil and rock, pollutant attenuation mechanisms include precipitation, sorption, physical filtration, and bacterial degradation. If functioning properly, this approach is presumed to have high removal efficiencies for particulate pollutants and moderate removal of soluble pollutants. Actual pollutant removal in the subsurface would be expected to vary depending upon site-specific soil types. This technology eliminates discharge to surface waters except for the very largest storms; consequently, complete removal of all stormwater constituents can be assumed.

There remain some concerns about the potential for groundwater contamination despite the findings of the NURP and Nightingale (1975; 1987a,b,c; 1989). For instance, a report by Pitt et al. (1994) highlighted the potential for groundwater contamination from intentional and unintentional stormwater infiltration. That report recommends that infiltration facilities not be sited in areas where high concentrations are present or where there is a potential for spills of toxic material. Conversely, Schroeder (1995) reported that there was no evidence of groundwater impacts from an infiltration basin serving a large industrial catchment in Fresno, CA.

## Siting Criteria

The key element in siting infiltration basins is identifying sites with appropriate soil and hydrogeologic properties, which is critical for long term performance. In one study conducted in Prince George's County, Maryland (Galli, 1992), all of the infiltration basins investigated clogged within 2 years. It is believed that these failures were for the most part due to allowing infiltration at sites with rates of less than 0.5 in/hr, basing siting on soil type rather than field infiltration tests, and poor construction practices that resulted in soil compaction of the basin invert.

A study of 23 infiltration basins in the Pacific Northwest showed better long-term performance in an area with highly permeable soils (Hilding, 1996). In this study, few of the infiltration basins had failed after 10 years. Consequently, the following guidelines for identifying appropriate soil and subsurface conditions should be rigorously adhered to.

- Determine soil type (consider RCS soil type 'A, B or C' only) from mapping and consult USDA soil survey tables to review other parameters such as the amount of silt and clay, presence of a restrictive layer or seasonal high water table, and estimated permeability. The soil should not have more than 30% clay or more than 40% of clay and silt combined. Eliminate sites that are clearly unsuitable for infiltration.
- Groundwater separation should be at least 3 m from the basin invert to the measured ground water elevation. There is concern at the state and regional levels of the impact on groundwater quality from infiltrated runoff, especially when the separation between groundwater and the surface is small.
- Location away from buildings, slopes and highway pavement (greater than 6 m) and wells and bridge structures (greater than 30 m). Sites constructed of fill, having a base flow or with a slope greater than 15% should not be considered.
- Ensure that adequate head is available to operate flow splitter structures (to allow the basin to be offline) without ponding in the splitter structure or creating backwater upstream of the splitter.

- Base flow should not be present in the tributary watershed.

### ***Secondary Screening Based on Site Geotechnical Investigation***

- At least three in-hole conductivity tests shall be performed using USBR 7300-89 or Bouwer-Rice procedures (the latter if groundwater is encountered within the boring), two tests at different locations within the proposed basin and the third down gradient by no more than approximately 10 m. The tests shall measure permeability in the side slopes and the bed within a depth of 3 m of the invert.
- The minimum acceptable hydraulic conductivity as measured in any of the three required test holes is 13 mm/hr. If any test hole shows less than the minimum value, the site should be disqualified from further consideration.
- Exclude from consideration sites constructed in fill or partially in fill unless no silts or clays are present in the soil boring. Fill tends to be compacted, with clays in a dispersed rather than flocculated state, greatly reducing permeability.
- The geotechnical investigation should be such that a good understanding is gained as to how the stormwater runoff will move in the soil (horizontally or vertically) and if there are any geological conditions that could inhibit the movement of water.

### **Additional Design Guidelines**

- (1) Basin Sizing - The required water quality volume is determined by local regulations or sufficient to capture 85% of the annual runoff.
- (2) Provide pretreatment if sediment loading is a maintenance concern for the basin.
- (3) Include energy dissipation in the inlet design for the basins. Avoid designs that include a permanent pool to reduce opportunity for standing water and associated vector problems.
- (4) Basin invert area should be determined by the equation:

$$A = \frac{WQV}{kt}$$

where A = Basin invert area (m<sup>2</sup>)

WQV = water quality volume (m<sup>3</sup>)

k = 0.5 times the lowest field-measured hydraulic conductivity (m/hr)

t = drawdown time ( 48 hr)

- (5) The use of vertical piping, either for distribution or infiltration enhancement shall not be allowed to avoid device classification as a Class V injection well per 40 CFR146.5(e)(4).

## Maintenance

Regular maintenance is critical to the successful operation of infiltration basins. Recommended operation and maintenance guidelines include:

- Inspections and maintenance to ensure that water infiltrates into the subsurface completely (recommended infiltration rate of 72 hours or less) and that vegetation is carefully managed to prevent creating mosquito and other vector habitats.
- Observe drain time for the design storm after completion or modification of the facility to confirm that the desired drain time has been obtained.
- Schedule semiannual inspections for beginning and end of the wet season to identify potential problems such as erosion of the basin side slopes and invert, standing water, trash and debris, and sediment accumulation.
- Remove accumulated trash and debris in the basin at the start and end of the wet season.
- Inspect for standing water at the end of the wet season.
- Trim vegetation at the beginning and end of the wet season to prevent establishment of woody vegetation and for aesthetic and vector reasons.
- Remove accumulated sediment and regrade when the accumulated sediment volume exceeds 10% of the basin.
- If erosion is occurring within the basin, revegetate immediately and stabilize with an erosion control mulch or mat until vegetation cover is established.
- To avoid reversing soil development, scarification or other disturbance should only be performed when there are actual signs of clogging, rather than on a routine basis. Always remove deposited sediments before scarification, and use a hand-guided rotary tiller, if possible, or a disc harrow pulled by a very light tractor.

## Cost

Infiltration basins are relatively cost-effective practices because little infrastructure is needed when constructing them. One study estimated the total construction cost at about \$2 per ft (adjusted for inflation) of storage for a 0.25-acre basin (SWRPC, 1991). As with other BMPs, these published cost estimates may deviate greatly from what might be incurred at a specific site. For instance, Caltrans spent about \$18/ft<sup>3</sup> for the two infiltration basins constructed in southern California, each of which had a water quality volume of about 0.34 ac.-ft. Much of the higher cost can be attributed to changes in the storm drain system necessary to route the runoff to the basin locations.

Infiltration basins typically consume about 2 to 3% of the site draining to them, which is relatively small. Additional space may be required for buffer, landscaping, access road, and fencing. Maintenance costs are estimated at 5 to 10% of construction costs.

One cost concern associated with infiltration practices is the maintenance burden and longevity. If improperly maintained, infiltration basins have a high failure rate. Thus, it may be necessary to replace the basin with a different technology after a relatively short period of time.

**References and Sources of Additional Information**

- Caltrans, 2002, BMP Retrofit Pilot Program Proposed Final Report, Rpt. CTSW-RT-01-050, California Dept. of Transportation, Sacramento, CA.
- Galli, J. 1992. *Analysis of Urban BMP Performance and Longevity in Prince George's County, Maryland*. Metropolitan Washington Council of Governments, Washington, DC.
- Hilding, K. 1996. Longevity of infiltration basins assessed in Puget Sound. *Watershed Protection Techniques* 1(3):124–125.
- Maryland Department of the Environment (MDE). 2000. *Maryland Stormwater Design Manual*. <http://www.mde.state.md.us/environment/wma/stormwatermanual>. Accessed May 22, 2002.
- Metzger, M. E., D. F. Messer, C. L. Beitia, C. M. Myers, and V. L. Kramer. 2002. The Dark Side Of Stormwater Runoff Management: Disease Vectors Associated With Structural BMPs. *Stormwater* 3(2): 24-39.
- Nightingale, H.I., 1975, "Lead, Zinc, and Copper in Soils of Urban Storm-Runoff Retention Basins," *American Water Works Assoc. Journal*. Vol. 67, p. 443-446.
- Nightingale, H.I., 1987a, "Water Quality beneath Urban Runoff Water Management Basins," *Water Resources Bulletin*, Vol. 23, p. 197-205.
- Nightingale, H.I., 1987b, "Accumulation of As, Ni, Cu, and Pb in Retention and Recharge Basin Soils from Urban Runoff," *Water Resources Bulletin*, Vol. 23, p. 663-672.
- Nightingale, H.I., 1987c, "Organic Pollutants in Soils of Retention/Recharge Basins Receiving Urban Runoff Water," *Soil Science* Vol. 148, pp. 39-45.
- Nightingale, H.I., Harrison, D., and Salo, J.E., 1985, "An Evaluation Technique for Ground-water Quality Beneath Urban Runoff Retention and Percolation Basins," *Ground Water Monitoring Review*, Vol. 5, No. 1, pp. 43-50.
- Oberts, G. 1994. Performance of Stormwater Ponds and Wetlands in Winter. *Watershed Protection Techniques* 1(2): 64–68.
- Pitt, R., et al. 1994, *Potential Groundwater Contamination from Intentional and Nonintentional Stormwater Infiltration*, EPA/600/R-94/051, Risk Reduction Engineering Laboratory, U.S. EPA, Cincinnati, OH.
- Schueler, T. 1987. *Controlling Urban Runoff: A Practical Manual for Planning and Designing Urban BMPs*. Metropolitan Washington Council of Governments, Washington, DC.
- Schroeder, R.A., 1995, *Potential For Chemical Transport Beneath a Storm-Runoff Recharge (Retention) Basin for an Industrial Catchment in Fresno, CA*, USGS Water-Resource Investigations Report 93-4140.

Southeastern Wisconsin Regional Planning Commission (SWRPC). 1991. *Costs of Urban Nonpoint Source Water Pollution Control Measures*. Southeastern Wisconsin Regional Planning Commission, Waukesha, WI.

U.S. EPA, 1983, *Results of the Nationwide Urban Runoff Program: Volume 1 – Final Report*, WH-554, Water Planning Division, Washington, DC.

Watershed Management Institute (WMI). 1997. *Operation, Maintenance, and Management of Stormwater Management Systems*. Prepared for U.S. Environmental Protection Agency Office of Water, Washington, DC.

### **Information Resources**

Center for Watershed Protection (CWP). 1997. *Stormwater BMP Design Supplement for Cold Climates*. Prepared for U.S. Environmental Protection Agency Office of Wetlands, Oceans and Watersheds. Washington, DC.

Ferguson, B.K., 1994. *Stormwater Infiltration*. CRC Press, Ann Arbor, MI.

USEPA. 1993. *Guidance to Specify Management Measures for Sources of Nonpoint Pollution in Coastal Waters*. EPA-840-B-92-002. U.S. Environmental Protection Agency, Office of Water, Washington, DC.

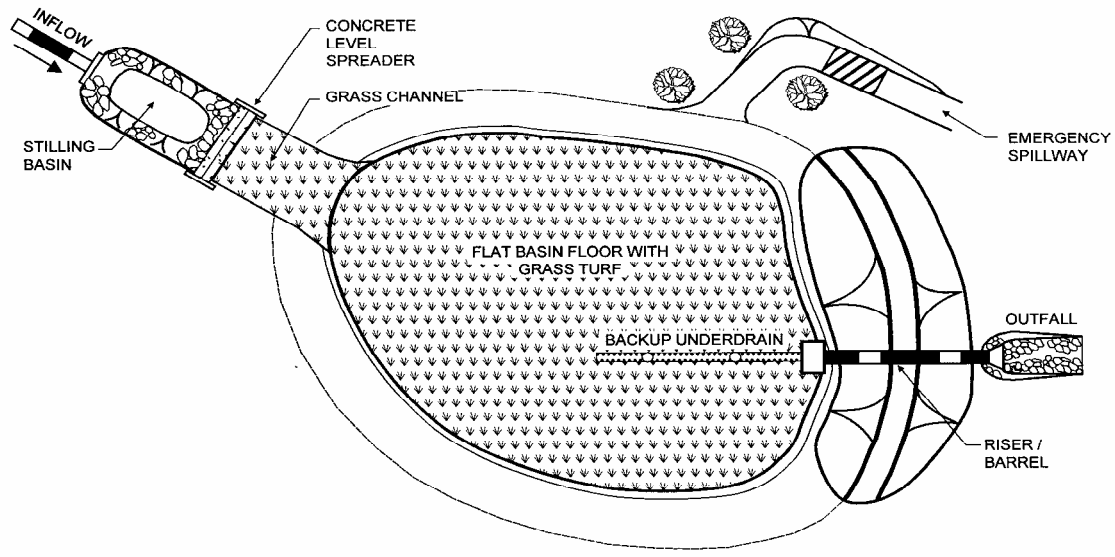

PLAN VIEW

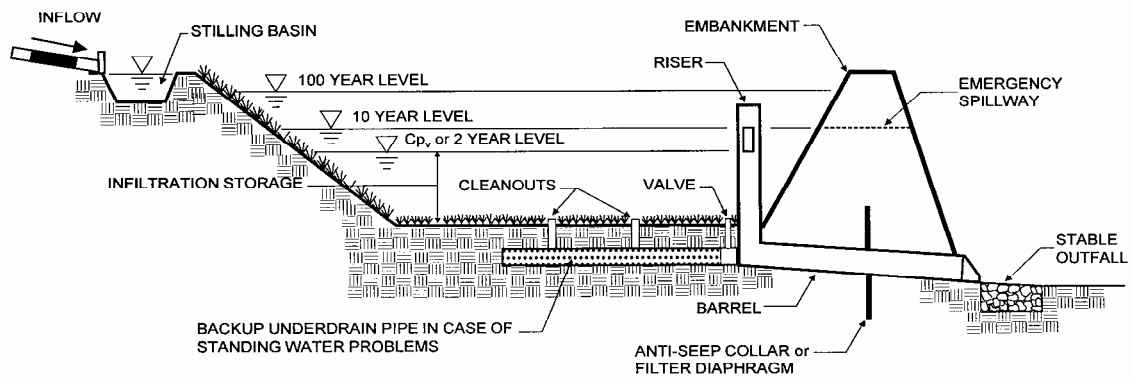

PROFILE

## Description

Retention/irrigation refers to the capture of stormwater runoff in a holding pond and subsequent use of the captured volume for irrigation of landscape or natural pervious areas. This technology is very effective as a stormwater quality practice in that, for the captured water quality volume, it provides virtually no discharge to receiving waters and high stormwater constituent removal efficiencies. This technology mimics natural undeveloped watershed conditions wherein the vast majority of the rainfall volume during smaller rainfall events is infiltrated through the soil profile. Their main advantage over other infiltration technologies is the use of an irrigation system to spread the runoff over a larger area for infiltration. This allows them to be used in areas with low permeability soils.

Capture of stormwater can be accomplished in almost any kind of runoff storage facility, ranging from dry, concrete-lined ponds to those with vegetated basins and permanent pools. The pump and wet well should be automated with a rainfall sensor to provide irrigation only during periods when required infiltration rates can be realized. Generally, a spray irrigation system is required to provide an adequate flow rate for distributing the water quality volume (LCRA, 1998). Collection of roof runoff for subsequent use (rainwater harvesting) also qualifies as a retention/irrigation practice.

This technology is still in its infancy and there are no published reports on its effectiveness, cost, or operational requirements. The guidelines presented below should be considered tentative until additional data are available.

## California Experience

This BMP has never been implemented in California, only in the Austin, Texas area. The use there is limited to watersheds where no increase in pollutant load is allowed because of the sensitive nature of the watersheds.

## Advantages

- Pollutant removal effectiveness is high, accomplished primarily by: (1) sedimentation in the primary storage facility; (2) physical filtration of particulates through the soil profile; (3) dissolved constituents uptake in the vegetative root zone by the soil-resident microbial community.

## Design Considerations

- Soil for Infiltration
- Area Required
- Slope
- Environmental Side-effects

## Targeted Constituents

<input checked="" type="checkbox"/>	Sediment	■
<input checked="" type="checkbox"/>	Nutrients	■
<input checked="" type="checkbox"/>	Trash	■
<input checked="" type="checkbox"/>	Metals	■
<input checked="" type="checkbox"/>	Bacteria	■
<input checked="" type="checkbox"/>	Oil and Grease	■
<input checked="" type="checkbox"/>	Organics	■

### Legend (*Removal Effectiveness*)

- Low
- High
- ▲ Medium



The hydrologic characteristics of this technique are effective for simulating pre-developed watershed conditions through: (1) containment of higher frequency flood volumes (less than about a 2-year event); and (2) reduction of flow rates and velocities for erosive flow events.

- Pollutant removal rates are estimated to be nearly 100% for all pollutants in the captured and irrigated stormwater volume. However, relatively frequent inspection and maintenance is necessary to assure proper operation of these facilities.
- This technology is particularly appropriate for areas with infrequent rainfall because the system is not required to operate often and the ability to provide stormwater for irrigation can reduce demand on surface and groundwater supplies.

### Limitations

- Retention-irrigation is a relatively expensive technology due primarily to mechanical systems, power requirements, and high maintenance needs.
- Due to the relative complexity of irrigation systems, they must be inspected and maintained at regular intervals to ensure reliable system function.
- Retention-irrigation systems use pumps requiring electrical energy inputs (which cost money, create pollution, and can be interrupted). Mechanical systems are also more complex, requiring skilled maintenance, and they are more vulnerable to vandalism than simpler, passive systems.
- Retention-irrigation systems require open space for irrigation and thus may be difficult to retrofit in urban areas.
- Effective use of retention irrigation requires some form of pre-treatment of runoff flows (i.e., sediment forebay or vegetated filter) to remove coarse sediment and to protect the long-term operating capacity of the irrigation equipment.
- Retention/irrigation BMPs capture and store water that, depending on design may be accessible to mosquitoes and other vectors for breeding.

### Design and Sizing Guidelines

- Runoff Storage Facility Configuration and Sizing - Design of the runoff storage facility is flexible as long as the water quality volume and an appropriate pump and wet well system can be accommodated.
- Pump and Wet Well System - A reliable pump, wet well, and rainfall or soil moisture sensor system should be used to distribute the water quality volume. These systems should be similar to those used for wastewater effluent irrigation, which are commonly used in areas where “no discharge” wastewater treatment plant permits are issued.
- Detention Time - The irrigation schedule should allow for complete drawdown of the water quality volume within 72 hours. Irrigation should not begin within 12 hours of the end of rainfall so that direct storm runoff has ceased and soils are not saturated. Consequently, the length of the active irrigation period is 60 hours. The irrigation should include a cycling factor of  $\frac{1}{2}$ , so that each portion of the area will be irrigated for only 30 hours during the



total of 60 hours allowed for disposal of the water quality volume. Irrigation also should not occur during subsequent rainfall events.

- **Irrigation System** - Generally a spray irrigation system is required to provide an adequate flow rate for timely distribution of the water quality volume.
- Designs that utilize covered water storage should be accessible to vector control personnel via access doors to facilitate vector surveillance and control if needed.
- **Irrigation Site Criteria** – The area selected for irrigation must be pervious, on slopes of less than 10%. A geological assessment is required for proposed irrigation areas to assure that there is a minimum of 12 inches of soil cover. Rocky soils are acceptable for irrigation; however, the coarse material (diameter greater than 0.5 inches) should not account for more than 30% of the soil volume. Optimum sites for irrigation include recreational and greenbelt areas as well as landscaping in commercial developments. The stormwater irrigation area should be distinct and different from any areas used for wastewater effluent irrigation. Finally, the area designated for irrigation should have at least a 100-foot buffer from wells, septic systems, and natural wetlands.
- **Irrigation Area** – The irrigation rate must be low enough so that the irrigation does not produce any surface runoff; consequently, the irrigation rate may not exceed the permeability of the soil. The minimum required irrigation area should be calculated using the following formula:

$$A = \frac{12 \times V}{T \times r}$$

where:

A = area required for irrigation (ft<sup>2</sup>)

V = water quality volume (ft<sup>3</sup>)

T = period of active irrigation (30 hr)

r = Permeability (in/hr)

- The permeability of the soils in the area proposed for irrigation should be determined using a double ring infiltrometer (ASTM D 3385-94) or from county soil surveys prepared by the Natural Resource Conservation Service. If a range of permeabilities is reported, the average value should be used in the calculation. If no permeability data is available, a value of 0.1 inches/hour should be assumed.
- It should be noted that the minimum area requires intermittent irrigation over a period of 60 hours at low rates to use the entire water quality volume. This intensive irrigation may be harmful to vegetation that is not adapted to long periods of wet conditions. In practice, a much larger irrigation area will provide better use of the retained water and promote a healthy landscape.

## Performance

This technology is still in its infancy and there are no published reports on its effectiveness, cost, or operational requirements.

## Siting Criteria

Capture of stormwater can be accomplished in almost any kind of runoff storage facility, ranging from dry, concrete-lined ponds to those with vegetated basins and permanent pools. Siting is contingent upon the type of facility used.

## Additional Design Guidelines

This technology is still in its infancy and there are no published reports on its effectiveness, cost, or operational requirements.

## Maintenance

Relatively frequent inspection and maintenance is necessary to verify proper operation of these facilities. Some maintenance concerns are specific to the type or irrigation system practice used.

BMPs that store water can become a nuisance due to mosquito and other vector breeding. Preventing mosquito access to standing water sources in BMPs (particularly below-ground) is the best prevention plan, but can prove challenging due to multiple entrances and the need to maintain the hydraulic integrity of the system. Reliance on electrical pumps is prone to failure and in some designs (e.g., sumps, vaults) may not provide complete dewatering, both which increase the chances of water standing for over 72 hours and becoming a breeding place for vectors. BMPs that hold water for over 72 hours and/or rely on electrical or mechanical devices to dewater may require routine inspections and treatments by local mosquito and vector control agencies to suppress mosquito production. Open storage designs such as ponds and basins (see appropriate fact sheets) will require routine preventative maintenance plans and may also require routine inspections and treatments by local mosquito and vector control agencies.

## Cost

This technology is still in its infancy and there are no published reports on its effectiveness, cost, or operational requirements. However, O&M costs for retention-irrigation systems are high compared to virtually all other stormwater quality control practices because of the need for: (1) frequent inspections; (2) the reliance on mechanical equipment; and (3) power costs.

## References and Sources of Additional Information

Barrett, M., 1999, *Complying with the Edwards Aquifer Rules: Technical Guidance on Best Management Practices*, Texas Natural Resource Conservation Commission Report RG-348. <http://www.tnrcc.state.tx.us/admin/topdoc/rg/348/index.html>

Lower-Colorado River Authority (LCRA), 1998, *Nonpoint Source Pollution Control Technical Manual*, Austin, TX.

Metzger, M. E., D. F. Messer, C. L. Beitia, C. M. Myers, and V. L. Kramer. 2002. The dark side of stormwater runoff management: disease vectors associated with structural BMPs. *Stormwater* 3(2): 24-39.

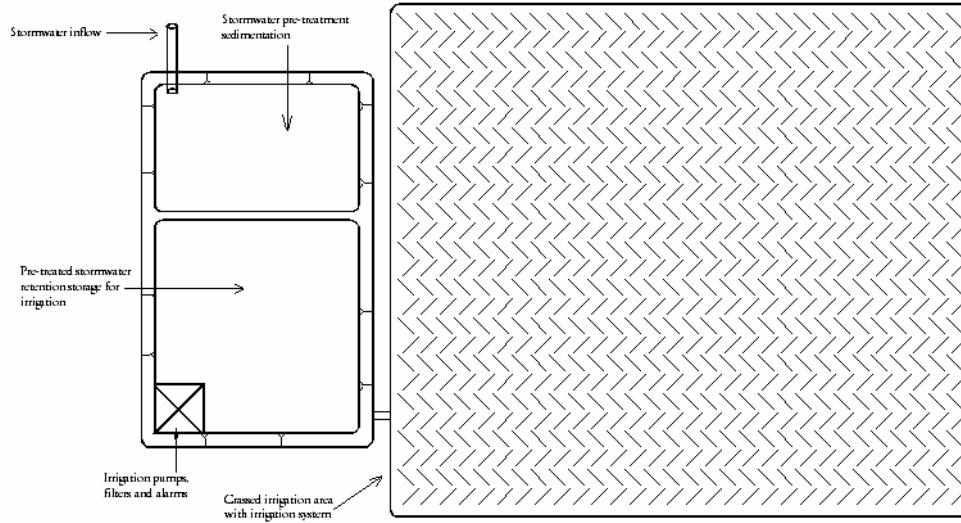





## Design Considerations

- Area Required
- Slope
- Water Availability
- Aesthetics
- Environmental Side-effects

## Description

Wet ponds (a.k.a. stormwater ponds, retention ponds, wet extended detention ponds) are constructed basins that have a permanent pool of water throughout the year (or at least throughout the wet season) and differ from constructed wetlands primarily in having a greater average depth. Ponds treat incoming stormwater runoff by settling and biological uptake. The primary removal mechanism is settling as stormwater runoff resides in this pool, but pollutant uptake, particularly of nutrients, also occurs to some degree through biological activity in the pond. Wet ponds are among the most widely used stormwater practices. While there are several different versions of the wet pond design, the most common modification is the extended detention wet pond, where storage is provided above the permanent pool in order to detain stormwater runoff and promote settling. The schematic diagram is of an on-line pond that includes detention for larger events, but this is not required in all areas of the state.

## California Experience

Caltrans constructed a wet pond in northern San Diego County (I-5 and La Costa Blvd.). Largest issues at this site were related to vector control, vegetation management, and concern that endangered species would become resident and hinder maintenance activities.

## Advantages

- If properly designed, constructed and maintained, wet basins can provide substantial aesthetic/recreational value and wildlife and wetlands habitat.
- Ponds are often viewed as a public amenity when integrated into a park setting.

## Targeted Constituents

<input checked="" type="checkbox"/>	Sediment	■
<input checked="" type="checkbox"/>	Nutrients	▲
<input checked="" type="checkbox"/>	Trash	■
<input checked="" type="checkbox"/>	Metals	■
<input checked="" type="checkbox"/>	Bacteria	■
<input checked="" type="checkbox"/>	Oil and Grease	■
<input checked="" type="checkbox"/>	Organics	■

### Legend (*Removal Effectiveness*)

- Low
- High
- ▲ Medium



- Due to the presence of the permanent wet pool, properly designed and maintained wet basins can provide significant water quality improvement across a relatively broad spectrum of constituents including dissolved nutrients.
- Widespread application with sufficient capture volume can provide significant control of channel erosion and enlargement caused by changes to flow frequency relationships resulting from the increase of impervious cover in a watershed.

### Limitations

- Some concern about safety when constructed where there is public access.
- Mosquito and midge breeding is likely to occur in ponds.
- Cannot be placed on steep unstable slopes.
- Need for base flow or supplemental water if water level is to be maintained.
- Require a relatively large footprint
- Depending on volume and depth, pond designs may require approval from the State Division of Safety of Dams

### Design and Sizing Guidelines

- Capture volume determined by local requirements or sized to treat 85% of the annual runoff volume.
- Use a draw down time of 48 hours in most areas of California. Draw down times in excess of 48 hours may result in vector breeding, and should be used only after coordination with local vector control authorities. Draw down times of less than 48 hours should be limited to BMP drainage areas with coarse soils that readily settle and to watersheds where warming may be detrimental to downstream fisheries.
- Permanent pool volume equal to twice the water quality volume.
- Water depth not to exceed about 8 feet.
- Wetland vegetation occupying no more than 25% of surface area.
- Include energy dissipation in the inlet design and a sediment forebay to reduce resuspension of accumulated sediment and facilitate maintenance.
- A maintenance ramp should be included in the design to facilitate access to the forebay for maintenance activities and for vector surveillance and control.
- To facilitate vector surveillance and control activities, road access should be provided along at least one side of BMPs that are seven meters or less in width. Those BMPs that have shoreline-to-shoreline distances in excess of seven meters should have perimeter road access on both sides or be designed such that no parcel of water is greater than seven meters from the road.

## ***Construction/Inspection Considerations***

- In areas with porous soils an impermeable liner may be required to maintain an adequate permanent pool level.
- Outlet structures and piping should be installed with collars to prevent water from seeping through the fill and causing structural failure.
- Inspect facility after first large storm to determine whether the desired residence time has been achieved.

## **Performance**

The observed pollutant removal of a wet pond is highly dependent on two factors: the volume of the permanent pool relative to the amount of runoff from the typical event in the area and the quality of the base flow that sustains the permanent pool. A recent study (Caltrans, 2002) has documented that if the permanent pool is much larger than the volume of runoff from an average event, then displacement of the permanent pool by the wet weather flow is the primary process. A statistical comparison of the wet pond discharge quality during dry and wet weather shows that they are not significantly different. Consequently, there is a relatively constant discharge quality during storms that is the same as the concentrations observed in the pond during ambient (dry weather) conditions. Consequently, for most constituents the performance of the pond is better characterized by the average effluent concentration, rather than the “percent reduction,” which has been the conventional measure of performance. Since the effluent quality is essentially constant, the percent reduction observed is mainly a function of the influent concentrations observed at a particular site.

The dry and wet weather discharge quality is, therefore, related to the quality of the base flow that sustains the permanent pool and of the transformations that occur to those constituents during their residence in the basin. One could potentially expect a wide range of effluent concentrations at different locations even if the wet ponds were designed according to the same guidelines, if the quality of the base flow differed significantly. This may explain the wide range of concentration reductions reported in various studies.

Concentrations of nutrients in base flow may be substantially higher than in urban stormwater runoff. Even though these concentrations may be substantially reduced during the residence time of the base flow in the pond, when this water is displaced by wet weather flows, concentrations may still be quite elevated compared to the levels that promote eutrophication in surface water systems. Consequently comparing influent and effluent nutrient concentrations during wet weather can make the performance seem highly variable.

Relatively small perennial flows may often substantially exceed the wet weather flow treated. Consequently, one should also consider the load reduction observed under ambient conditions when assessing the potential benefit to the receiving water.

## **Siting Criteria**

Wet ponds are a widely applicable stormwater management practice and can be used over a broad range of storm frequencies and sizes, drainage areas and land use types. Although they have limited applicability in highly urbanized settings and in arid climates, they have few other restrictions. Wet basins may be constructed on- or off-line and can be sited at feasible locations along established drainage ways with consistent base flow. An off-line design is preferred. Wet basins are often utilized in smaller sub-watersheds and are particularly appropriate in areas with residential land

uses or other areas where high nutrient loads are considered to be potential problems (e.g., golf courses).

Ponds do not consume a large area (typically 2–3 percent of the contributing drainage area); however, these facilities are generally large. Other practices, such as filters or swales, may be "squeezed" into relatively unusable land, but ponds need a relatively large continuous area. Wet basins are typically used in drainage basins of more than ten acres and less than one square mile (Schueler et al., 1992). Emphasis can be placed in siting wet basins in areas where the pond can also function as an aesthetic amenity or in conjunction with other stormwater management functions.

Wet basin application is appropriate in the following settings: (1) where there is a need to achieve a reasonably high level of dissolved contaminant removal and/or sediment capture; (2) in small to medium-sized regional tributary areas with available open space and drainage areas greater than about 10 ha (25 ac.); (3) where base flow rates or other channel flow sources are relatively consistent year-round; (4) in residential settings where aesthetic and wildlife habitat benefits can be appreciated and maintenance activities are likely to be consistently undertaken.

Traditional wet extended detention ponds can be applied in most regions of the United States, with the exception of arid climates. In arid regions, it is difficult to justify the supplemental water needed to maintain a permanent pool because of the scarcity of water. Even in semi-arid Austin, Texas, one study found that 2.6 acre-feet per year of supplemental water was needed to maintain a permanent pool of only 0.29 acre-feet (Saunders and Gilroy, 1997). Seasonal wet ponds (i.e., ponds that maintain a permanent pool only during the wet season) may prove effective in areas with distinct wet and dry seasons; however, this configuration has not been extensively evaluated.

Wet ponds may pose a risk to cold water systems because of their potential for stream warming. When water remains in the permanent pool, it is heated by the sun. A study in Prince George's County, Maryland, found that stormwater wet ponds heat stormwater by about 9°F from the inlet to the outlet (Galli, 1990).

### **Additional Design Guidelines**

Specific designs may vary considerably, depending on site constraints or preferences of the designer or community. There are several variations of the wet pond design, including constructed wetlands, and wet extended detention ponds. Some of these design alternatives are intended to make the practice adaptable to various sites and to account for regional constraints and opportunities. In conventional wet ponds, the open water area comprises 50% or more of the total surface area of the pond. The permanent pool should be no deeper than 2.5 m (8 feet) and should average 1.2 – 2 m (4-6 feet) deep. The greater depth of this configuration helps limit the extent of the vegetation to an aquatic bench around the perimeter of the pond with a nominal depth of about 1 foot and variable width. This shallow bench also protects the banks from erosion, enhances habitat and aesthetic values, and reduces the drowning hazard.

The wet extended detention pond combines the treatment concepts of the dry extended detention pond and the wet pond. In this design, the water quality volume is detained above the permanent pool and released over 24 hours. In addition to increasing the residence time, which improves pollutant removal, this design also attenuates peak runoff rates. Consequently, this design alternative is recommended.



Pretreatment incorporates design features that help to settle out coarse sediment particles. By removing these particles from runoff before they reach the large permanent pool, the maintenance burden of the pond is reduced. In ponds, pretreatment is achieved with a sediment forebay. A sediment forebay is a small pool (typically about 10 percent of the volume of the permanent pool). Coarse particles remain trapped in the forebay, and maintenance is performed on this smaller pool, eliminating the need to dredge the entire pond.

There are a variety of sizing criteria for determining the volume of the permanent pool, mostly related to the water quality volume (i.e., the volume of water treated for pollutant removal) or the average storm size in a particular area. In addition, several theoretical approaches to determination of permanent pool volume have been developed. However, there is little empirical evidence to support these designs. Consequently, a simplified method (i.e., permanent pool volume equal to twice the water quality volume) is recommended.

Other design features do not increase the volume of a pond, but can increase the amount of time stormwater remains in the device and eliminate short-circuiting. Ponds should always be designed with a length-to-width ratio of at least 1.5:1, where feasible. In addition, the design should incorporate features to lengthen the flow path through the pond, such as underwater berms designed to create a longer route through the pond. Combining these two measures helps ensure that the entire pond volume is used to treat stormwater. Wet ponds with greater amounts of vegetation often have channels through the vegetated areas and contain dead areas where stormwater is restricted from mixing with the entire permanent pool, which can lead to less pollutant removal. Consequently, a pond with open water comprising about 75% of the surface area is preferred.

Design features are also incorporated to ease maintenance of both the forebay and the main pool of ponds. Ponds should be designed with a maintenance access to the forebay to ease this relatively routine (every 5–7 year) maintenance activity. In addition, ponds should generally have a drain to draw down the pond for vegetation harvesting or the more infrequent dredging of the main cell of the pond.

Cold climates present many challenges to designers of wet ponds. The spring snowmelt may have a high pollutant load and a large volume to be treated. In addition, cold winters may cause freezing of the permanent pool or freezing at inlets and outlets. Finally, high salt concentrations in runoff resulting from road salting, and sediment loads from road sanding, may impact pond vegetation as well as reduce the storage and treatment capacity of the pond.

One option to deal with high pollutant loads and runoff volumes during the spring snowmelt is the use of a seasonally operated pond to capture snowmelt during the winter and retain the permanent pool during warmer seasons. In this option, proposed by Oberts (1994), the pond has two water quality outlets, both equipped with gate valves. In the summer, the lower outlet is closed. During the fall and throughout the winter, the lower outlet is opened to draw down the permanent pool. As the spring melt begins, the lower outlet is closed to provide detention for the melt event. The manipulation of this system requires some labor and vigilance; a careful maintenance agreement should be confirmed.

Several other modifications may help to improve the performance of ponds in cold climates. Designers should consider planting the pond with salt-tolerant vegetation if the facility receives road runoff. In order to counteract the effects of freezing on inlet and outlet structures, the use of inlet and outlet structures that are resistant to frost, including weirs and larger diameter pipes, may be

useful. Designing structures on-line, with a continuous flow of water through the pond, will also help prevent freezing of these structures. Finally, since freezing of the permanent pool can reduce the effectiveness of pond systems, it is important to incorporate extended detention into the design to retain usable treatment area above the permanent pool when it is frozen.

#### *Summary of Design Recommendations*

- (1) **Facility Sizing** – The basin should be sized to hold the permanent pool as well as the required water quality volume. The volume of the permanent pool should equal twice the water quality volume.
- (2) **Pond Configuration** - The wet basin should be configured as a two stage facility with a sediment forebay and a main pool. The basins should be wedge-shaped, narrowest at the inlet and widest at the outlet. The minimum length to width ratio should be 1.5 where feasible. The perimeter of all permanent pool areas with depths of 4.0 feet or greater should be surrounded by an aquatic bench. This bench should extend inward 5-10 feet from the perimeter of the permanent pool and should be no more than 18 inches below normal depth. The area of the bench should not exceed about 25% of pond surface. The depth in the center of the basin should be 4 – 8 feet deep to prevent vegetation from encroaching on the pond open water surface.
- (3) **Pond Side Slopes** - Side slopes of the basin should be 3:1 (H:V) or flatter for grass stabilized slopes. Slopes steeper than 3:1 should be stabilized with an appropriate slope stabilization practice.
- (4) **Sediment Forebay** - A sediment forebay should be used to isolate gross sediments as they enter the facility and to simplify sediment removal. The sediment forebay should consist of a separate cell formed by an earthen berm, gabion, or loose riprap wall. The forebay should be sized to contain 15 to 25% of the permanent pool volume and should be at least 3 feet deep. Exit velocities from the forebay should not be erosive. Direct maintenance access should be provided to the forebay. The bottom of the forebay may be hardened (concrete) to make sediment removal easier. A fixed vertical sediment depth marker should be installed in the forebay to measure sediment accumulation.
- (5) **Outflow Structure** - Figure 2 presents a schematic representation of suggested outflow structures. The outlet structure should be designed to drain the water quality volume over 24 hours with the orifice sized according to the equation presented in the Extended Detention Basin fact sheet. The facility should have a separate drain pipe with a manual valve that can completely or partially drain the pond for maintenance purposes. To allow for possible sediment accumulation, the submerged end of the pipe should be protected, and the drain pipe should be sized to drain the pond within 24 hours. The valve should be located at a point where it can be operated in a safe and convenient manner.

For on-line facilities, the principal and emergency spillways must be sized to provide 1.0 foot of freeboard during the 25-year event and to safely pass the 100-year flood. The embankment should be designed in accordance with all relevant specifications for small dams.

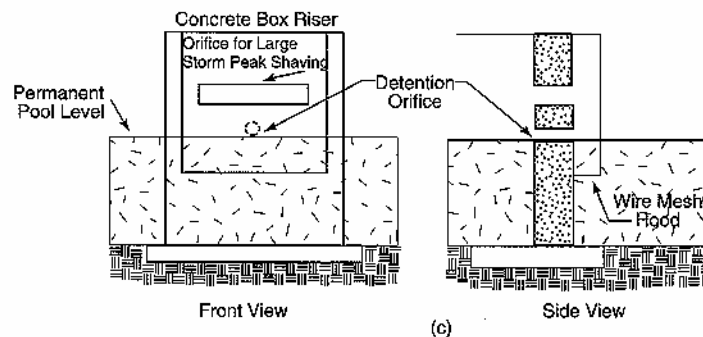
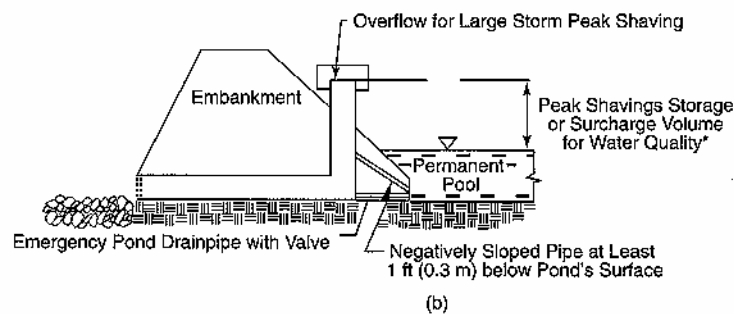
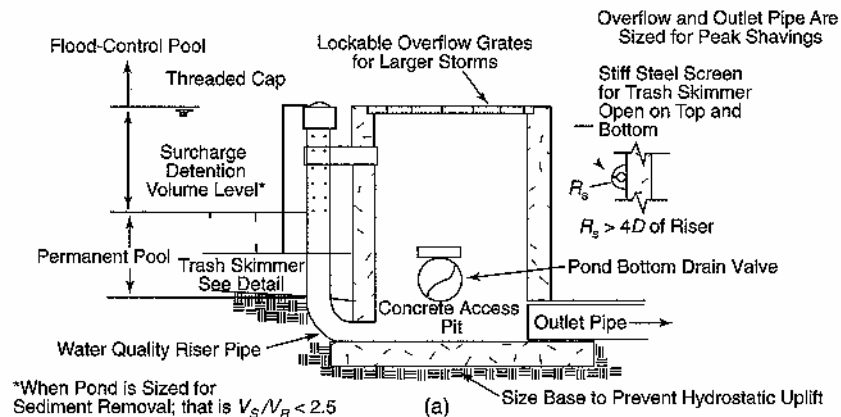

- (6) **Splitter Box** - When the pond is designed as an off-line facility, a splitter structure is used to isolate the water quality volume. The splitter box, or other flow diverting approach, should be designed to convey the 25-year event while providing at least 1.0 foot of freeboard along pond side slopes.
- (7) **Vegetation** - A plan should be prepared that indicates how aquatic and terrestrial areas will be vegetatively stabilized. Wetland vegetation elements should be placed along the aquatic bench or in the shallow portions of the permanent pool. The optimal elevation for planting of wetland vegetation is within 6 inches vertically of the normal pool elevation. A list of some wetland vegetation native to California is presented in Table 1.

Table 1 California Wetland Vegetation	
Botanical Name	Common Name
BACCHARIS SALICIFOLIA	MULE FAT
FRANKENIA GRANDIFOLIA	HEATH
SALIX GOODINGII	BLACK WILLOW
SALIX LASIOLEPIS	ARROYO WILLOW
SAMUCUS MEXICANUS	MEXICAN ELDERBERRY
HAPLOPAPPUS VENETUS	COAST GOLDENBRUSH
DISTICHIS SPICATA	SALT GRASS
LIMONIUM CALIFORNICUM	COASTAL STATICE
ATRIPLEX LENTIFORMIS	COASTAL QUAIL BUSH
BACCHARIS PILULARIS	CHAPARRAL BROOM
MIMULUS LONGIFLORUS	MONKEY FLOWER
SCIRPUS CALIFORNICUS	BULRUSH
SCIRPUS ROBUSTUS	BULRUSH
TYPHA LATIFOLIA	BROADLEAF CATTAIL
JUNCUS ACUTUS	RUSH

**Maintenance**

The amount of maintenance required for a wet pond is highly dependent on local regulatory agencies, particular health and vector control agencies. These agencies are often extremely concerned about the potential for mosquito breeding that may occur in the permanent pool. Even though mosquito fish (*Gambusia affinis*) were introduced into a wet pond constructed by Caltrans in the San Diego area, mosquito breeding was routinely observed during inspections. In addition, the vegetation at this site became sufficiently dense on the bench around the edge of the pool that mosquito fish were unable to enter this area to feed upon the mosquito larvae. The vegetation at this site was particularly vigorous because of the high nutrient concentrations in the perennial base flow (15.5 mg/L NO3-N) and the mild climate, which permitted growth year round. Consequently, the vector control agency required an annual harvest of vegetation to address this situation. This harvest can be very expensive.

On the other hand, routine harvesting may increase nutrient removal and prevent the export of these constituents from dead and dying plants falling in the water. A previous study (Faulkner and Richardson, 1991) documented dramatic reductions in nutrient removal after the first several years of operation and related it to the vegetation achieving a maximum density. That content then decreases through the growth season, as the total biomass increases. In effect, the total amount of

nutrients/m<sup>2</sup> of wetland remains essentially the same from June through September, when the plants start to put the P back into the rhizomes. Therefore harvesting should occur between June and September. Research also suggests that harvesting only the foliage is less effective, since a very small percentage of the removed nutrients is taken out with harvesting.

Since wet ponds are often selected for their aesthetic considerations as well as pollutant removal, they are often sited in areas of high visibility. Consequently, floating litter and debris are removed more frequently than would be required simply to support proper functioning of the pond and outlet. This is one of the primary maintenance activities performed at the Central Market Pond located in Austin, Texas. In this type of setting, vegetation management in the area surrounding the pond can also contribute substantially to the overall maintenance requirements.

One normally thinks of sediment removal as one of the typical activities performed at stormwater BMPs. This activity does not normally constitute one of the major activities on an annual basis. At the concentrations of TSS observed in urban runoff from stable watersheds, sediment removal may only be required every 20 years or so. Because this activity is performed so infrequently, accurate costs for this activity are lacking.

In addition to regular maintenance activities needed to maintain the function of wet ponds, some design features can be incorporated to ease the maintenance burden. In wet ponds, maintenance reduction features include techniques to reduce the amount of maintenance needed, as well as techniques to make regular maintenance activities easier.

One potential maintenance concern in wet ponds is clogging of the outlet. Ponds should be designed with a non-clogging outlet such as a reverse-slope pipe, or a weir outlet with a trash rack. A reverse-slope pipe draws from below the permanent pool extending in a reverse angle up to the riser and establishes the water elevation of the permanent pool. Because these outlets draw water from below the level of the permanent pool, they are less likely to be clogged by floating debris.

Typical maintenance activities and frequencies include:

- Schedule semiannual inspections for burrows, sediment accumulation, structural integrity of the outlet, and litter accumulation.
- Remove accumulated trash and debris in the basin at the middle and end of the wet season. The frequency of this activity may be altered to meet specific site conditions and aesthetic considerations.
- Where permitted by the Department of Fish and Game or other agency regulations, stock wet ponds/constructed wetlands regularly with mosquito fish (*Gambusia spp.*) to enhance natural mosquito and midge control.
- Introduce mosquito fish and maintain vegetation to assist their movements to control mosquitoes, as well as to provide access for vector inspectors. An annual vegetation harvest in summer appears to be optimum, in that it is after the bird breeding season, mosquito fish can provide the needed control until vegetation reaches late summer density, and there is time for re-growth for runoff treatment purposes before the wet season. In certain cases, more frequent plant harvesting may be required by local vector control agencies.

- Maintain emergent and perimeter shoreline vegetation as well as site and road access to facilitate vector surveillance and control activities.
- Remove accumulated sediment in the forebay and regrade about every 5-7 years or when the accumulated sediment volume exceeds 10 percent of the basin volume. Sediment removal may not be required in the main pool area for as long as 20 years.

## Cost

### **Construction Cost**

Wet ponds can be relatively inexpensive stormwater practices; however, the construction costs associated with these facilities vary considerably. Much of this variability can be attributed to the degree to which the existing topography will support a wet pond, the complexity and amount of concrete required for the outlet structure, and whether it is installed as part of new construction or implemented as a retrofit of existing storm drain system.

A recent study (Brown and Schueler, 1997) estimated the cost of a variety of stormwater management practices. The study resulted in the following cost equation, adjusting for inflation:

$$C = 24.5V^{0.705}$$

where:

C = Construction, design and permitting cost;

V = Volume in the pond to include the 10-year storm (ft<sup>3</sup>).

Using this equation, typical construction costs are:

\$45,700 for a 1 acre-foot facility

\$232,000 for a 10 acre-foot facility

\$1,170,000 for a 100 acre-foot facility

In contrast, Caltrans (2002) reported spending over \$448,000 for a pond with a total permanent pool plus water quality volume of only 1036 m<sup>3</sup> (0.8 ac.-ft.), while the City of Austin spent \$584,000 (including design) for a pond with a permanent pool volume of 3,100 m<sup>3</sup> (2.5 ac.-ft.). The large discrepancies between the costs of these actual facilities and the model developed by Brown and Schueler indicate that construction costs are highly site specific, depending on topography, soils, subsurface conditions, the local labor, rate and other considerations.

### **Maintenance Cost**

For ponds, the annual cost of routine maintenance has typically been estimated at about 3 to 5 percent of the construction cost; however, the published literature is almost totally devoid of actual maintenance costs. Since ponds are long-lived facilities (typically longer than 20 years), major maintenance activities are unlikely to occur during a relatively short study.

Caltrans (2002) estimated annual maintenance costs of \$17,000 based on three years of monitoring of a pond treating runoff from 1.7 ha. Almost all the activities are associated with the annual vegetation harvest for vector control. Total cost at this site falls within the 3-5% range reported

above; however, the construction costs were much higher than those estimated by Brown and Schueler (1997). The City of Austin has been reimbursing a developer about \$25,000/yr for wet pond maintenance at a site located at a very visible location. Maintenance costs are mainly the result of vegetation management and litter removal. On the other hand, King County estimates annual maintenance costs at about \$3,000 per pond; however, this cost likely does not include annual extensive vegetation removal. Consequently, maintenance costs may vary considerably at sites in California depending on the aggressiveness of the vegetation management in that area and the frequency of litter removal.

### References and Sources of Additional Information

Amalfi, F.A., R. Kadlec, R.L. Knight, G. O'Meara, W.K. Reisen, W.E. Walton, and R. Wass. 1999. A Mosquito Control Strategy For The Tres Rios Demonstration Constructed Wetlands. CH2M Hill, Tempe, AZ, 140 pp.

Bannerman, R., and R. Dodds. 1992. Unpublished data. Bureau of Water Resources Management, Wisconsin Department of Natural Resources, Madison, WI.

Borden, R. C., J.L. Dorn, J.B. Stillman, and S.K. Liehr; 1996. *Evaluation of Ponds and Wetlands for Protection of Public Water Supplies*. Draft Report. Water Resources Research Institute of the University of North Carolina, Department of Civil Engineering, North Carolina State University, Raleigh, NC.

Brown, W., and T. Schueler. 1997. *The Economics of Stormwater BMPs in the Mid-Atlantic Region*. Prepared for the Chesapeake Research Consortium, Edgewater, MD, by the Center for Watershed Protection; Ellicott City, MD.

Caltrans, 2002, *Proposed Final Report: BMP Retrofit Pilot Program*, California Dept. of Transportation Report CTSW-RT-01-050, and Sacramento, CA.

City of Austin, TX. 1991. *Design Guidelines for Water Quality Control Basins*. Public Works Department, Austin, TX.

City of Austin, TX. 1996. Evaluation of Non-Point Source Controls: A 319 Grant Project. Draft Water Quality Report Series, Public Works Department, Austin, TX.

Cullum, M. 1985. Stormwater Runoff Analysis at a Single Family Residential Site. Publication 85-1. University of Central Florida, Orlando, FL. pp. 247–256.

Dorman, M.E., J. Hartigan, R.F. Steg, and T. Quasebarth. 1989. *Retention, Detention and Overland Flow for Pollutant Removal From Highway Stormwater Runoff*. Vol. 1 Research Report. FHWA/RD 89/202. Federal Highway Administration, Washington, DC.

Dorothy, J.M., and K. Staker. 1990. A preliminary Survey For Mosquito Breeding In Stormwater Retention Ponds In Three Maryland Counties. Mosquito Control, Maryland Department of Agriculture, College Park, MD. 5 pp.

Driscoll, E.D. 1983. *Performance of Detention Basins for Control of Urban Runoff Quality*. Presented at the 1983 International Symposium on Urban Hydrology, Hydraulics and Sedimentation Control, University of Kentucky, Lexington, KY.

- Emmerling-Dinovo, C. 1995. Stormwater detention basins and residential locational decisions. *Water Resources Bulletin*, 31(3):515–52.
- Faulkner, S. and Richardson, C., 1991, Physical and chemical characteristics of freshwater wetland soils, in *Constructed Wetlands for Wastewater Treatment*, ed. D. Hammer, Lewis Publishers, 831 pp.
- Gain, W.S. 1996. *The Effects of Flow Path Modification on Water Quality Constituent Retention in an Urban Stormwater Detention Pond and Wetland System*. Water Resources Investigations Report 95-4297. U.S. Geological Survey, Tallahassee, FL.
- Galli, F. 1990. *Thermal Impacts Associated with Urbanization and Stormwater Best Management Practices*. Prepared for the Maryland Department of the Environment, Baltimore, MD, by the Metropolitan Council of Governments, Washington, DC.
- Glick, Roger, 2001, personal communication, City of Austin Watershed Protection Dept., Austin, TX.
- Holler, J.D. 1989. Water Quality Efficiency Of An Urban Commercial Wet Detention Stormwater Management System At Boynton Beach Mall in South Palm Beach County, FL. *Florida Scientist* 52(1):48–57.
- Holler, J.D. 1990. Nonpoint Source Phosphorous Control By A Combination Wet Detention/ Filtration Facility In Kissimmee, FL. *Florida Scientist* 53(1):28–37.
- Horner, R.R., J. Guedry, and M.H. Kortenhoff. 1990. *Improving the Cost Effectiveness of Highway Construction Site Erosion and Pollution Control*. Final Report. Washington State Transportation Commission, Olympia, WA.
- Kantrowitz .I. and W. Woodham 1995. *Efficiency of a Stormwater Detention Pond in Reducing Loads of Chemical and Physical Constituents in Urban Stream flow, Pinellas County, Florida*. Water Resources Investigations Report 94-4217. U.S. Geological Survey, Tallahassee, FL.
- Martin, E. 1988. Effectiveness of an urban runoff detention pond/wetland system. *Journal of Environmental Engineering* 114(4):810–827.
- Maryland Department of the Environment (MDE). 2000. *Maryland Stormwater Design Manual*. <http://www.mde.state.md.us/environment/wma/stormwatermanual>.
- McLean, J. 2000. Mosquitoes In Constructed Wetlands: A Management Bugaboo? In T.R. Schueler and H.K. Holland [eds.], *The Practice of Watershed Protection*. pp. 29-33. Center for Watershed Protection, Ellicott City, MD.
- Metzger, M. E., D. F. Messer, C. L. Beitia, C. M. Myers, and V. L. Kramer. 2002. The Dark Side Of Stormwater Runoff Management: Disease Vectors Associated With Structural BMPs. *Stormwater* 3(2): 24-39.
- Oberts, G.L. 1994. Performance of stormwater ponds and wetlands in winter. *Watershed Protection Techniques* 1(2):64–68.



Oberts, G.L., P.J. Wotzka, and J.A. Hartsoe. 1989. *The Water Quality Performance of Select Urban Runoff Treatment Systems*. Publication No. 590-89-062a. Prepared for the Legislative Commission on Minnesota Resources, Metropolitan Council, St. Paul, MN.

Oberts, G.L., and L. Wotzka. 1988. The water quality performance of a detention basin wetland treatment system in an urban area. In *Nonpoint Source Pollution: Economy, Policy, Management and Appropriate Technology*. American Water Resources Association, Middleburg, VA.

Occoquan Watershed Monitoring Laboratory. 1983. Metropolitan Washington Urban Runoff Project. Final Report. Prepared for the Metropolitan Washington Council of Governments, Washington, DC, by the Occoquan Watershed Monitoring Laboratory, Manassas, VA.

Ontario Ministry of the Environment. 1991. *Stormwater Quality Best Management Practices*. Marshall Macklin Monaghan Limited, Toronto, Ontario.

Protection Agency, Office of Water, Washington, DC, by the Watershed Management Institute, Ingleside, MD.

Santana, F.J., J.R. Wood, R.E. Parsons, and S.K. Chamberlain. 1994. Control Of Mosquito Breeding In Permitted Stormwater Systems. Sarasota County Mosquito Control and Southwest Florida Water Management District, Brooksville, FL., 46 pp.

Saunders, G. and M. Gilroy, 1997. *Treatment of Nonpoint Source Pollution with Wetland/Aquatic Ecosystem Best Management Practices*. Texas Water Development Board, Lower Colorado River Authority, Austin, TX.

Schueler, T. 1997a. Comparative pollutant removal capability of urban BMPs: A reanalysis. *Watershed Protection Techniques* 2(4):515–520.

Schueler, T. 1997b. Influence of groundwater on performance of stormwater ponds in Florida. *Watershed Protection Techniques* 2(4):525–528.

Urbanas, B., J. Carlson, and B. Vang. 1994. Joint Pond-Wetland System in Colorado. Denver Urban Drainage and Flood Control District, Denver, CO.

U.S. Environmental Protection Agency (USEPA). 1995. *Economic Benefits of Runoff Controls*. U.S. Environmental Protection Agency, Office of Wetlands, Oceans, and Watersheds, Washington, DC.

Watershed Management Institute (WMI). 1997. *Operation, Maintenance, and Management of Stormwater Management Systems*. Prepared for U.S. Environmental Protection Agency, Office of Water, Washington, DC, by the Watershed Management Institute, Ingleside, MD.  
Water Environment Federation and ASCE, 1998, *Urban Runoff Quality Management*, WEF Manual of Practice No. 23 and ASCE Manual and Report on Engineering Practice No. 87.

Wu, J. 1989. Evaluation of Detention Basin Performance in the Piedmont Region of North Carolina. Report No. 89-248. North Carolina Water Resources Research Institute, Raleigh, NC.

Yousef, Y., M. Wanielista, and H. Harper. 1986. Design and Effectiveness of Urban Retention Basins. In *Urban Runoff Quality—Impact and Quality Enhancement Technology*. B. Urbanas and L.A. Roesner (Eds.). American Society of Civil Engineering, New York, New York. pp. 338–350.

**Information Resources**

- Center for Watershed Protection (CWP). 1995. *Stormwater Management Pond Design Example for Extended Detention Wet Pond*. Center for Watershed Protection, Ellicott City, MD.
- Center for Watershed Protection (CWP). 1997. *Stormwater BMP Design Supplement for Cold Climates*. Prepared for U.S. Environmental Protection Agency, Office of Wetlands, Oceans and Watersheds, Washington, DC, by the Center for Watershed Protection, Ellicott City, MD.
- Denver Urban Drainage and Flood Control District. 1992. *Urban Storm Drainage Criteria Manual—Volume 3: Best Management Practices*. Denver Urban Drainage and Flood Control District, Denver, CO.
- Galli, J. 1992. *Preliminary Analysis of the Performance and Longevity of Urban BMPs Installed in Prince George's County, Maryland*. Prince George's County, Maryland, Department of Natural Resources, Largo, MD.
- MacRae, C. 1996. Experience from Morphological Research on Canadian Streams: Is Control of the Two-Year Frequency Runoff Event the Best Basis for Stream Channel Protection? In *Effects of Watershed Development and Management on Aquatic Ecosystems*. American Society of Civil Engineers. Snowbird, UT. pp. 144–162.
- Minnesota Pollution Control Agency. 1989. *Protecting Water Quality in Urban Areas: Best Management Practices*. Minnesota Pollution Control Agency, Minneapolis, MN.
- U.S. Environmental Protection Agency (USEPA). 1993. *Guidance Specifying Management Measures for Sources of Nonpoint Pollution in Coastal Waters*. EPA-840-B-92-002. U.S. Environmental Protection Agency, Office of Water, Washington, DC.

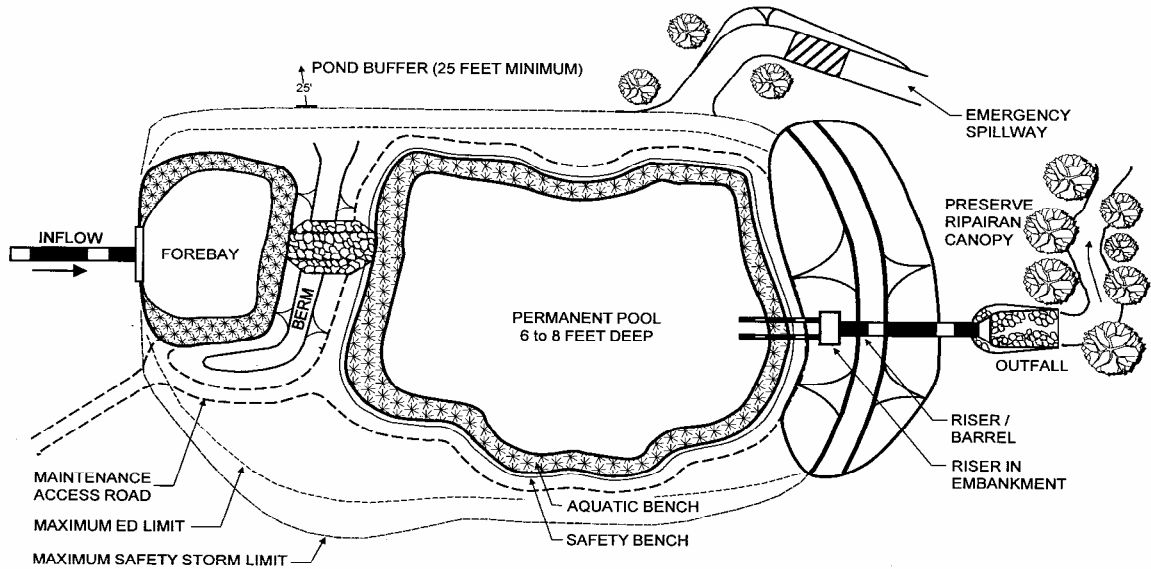

**PLAN VIEW**

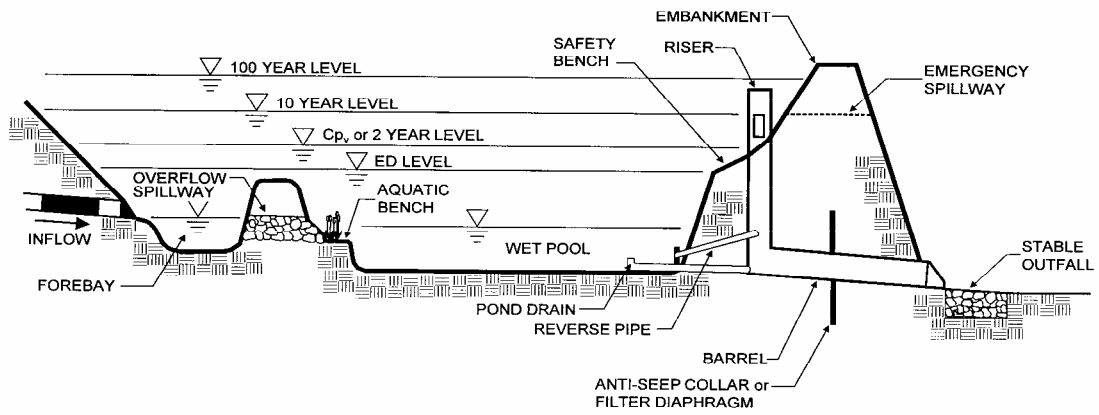

**PROFILE**





## Description

Constructed wetlands are constructed basins that have a permanent pool of water throughout the year (or at least throughout the wet season) and differ from wet ponds primarily in being shallower and having greater vegetation coverage. The schematic diagram is of an on-line pond that includes detention for larger events, but this is not required in all areas of the state.

A distinction should be made between using a constructed wetland for storm water management and diverting storm water into a natural wetland. The latter practice is not recommended and in all circumstances, natural wetlands should be protected from the adverse effects of development, including impacts from increased storm water runoff. This is especially important because natural wetlands provide storm water and flood control benefits on a regional scale.

Wetlands are among the most effective stormwater practices in terms of pollutant removal and they also offer aesthetic value. As stormwater runoff flows through the wetland, pollutant removal is achieved through settling and biological uptake within the wetland. Flow through the root systems forces the vegetation to remove nutrients and dissolved pollutants from the stormwater.

## California Experience

The City of Laguna Niguel in Orange County has constructed several wetlands, primarily to reduce bacteria concentrations in dry weather flows. The wetlands have been very successful in this regard. Even though there is not enough perennial flow to maintain the permanent pool at a constant elevation, the wetland vegetation has thrived.

## Design Considerations

- Area Required
- Slope
- Water Availability
- Aesthetics
- Environmental Side-effects

## Targeted Constituents

<input checked="" type="checkbox"/>	Sediment	■
<input checked="" type="checkbox"/>	Nutrients	▲
<input checked="" type="checkbox"/>	Trash	■
<input checked="" type="checkbox"/>	Metals	■
<input checked="" type="checkbox"/>	Bacteria	■
<input checked="" type="checkbox"/>	Oil and Grease	■
<input checked="" type="checkbox"/>	Organics	■

### Legend (Removal Effectiveness)

- Low
- ▲ Medium
- High



**Advantages**

- If properly designed, constructed and maintained, wet basins can provide substantial wildlife and wetlands habitat.
- Due to the presence of the permanent wet pool, properly designed and maintained wet basins can provide significant water quality improvement across a relatively broad spectrum of constituents including dissolved nutrients.
- Widespread application with sufficient capture volume can provide significant control of channel erosion and enlargement caused by changes to flow frequency relationships resulting from the increase of impervious cover in a watershed.

**Limitations**

- There may be some aesthetic concerns about a facility that looks swampy.
- Some concern about safety when constructed where there is public access.
- Mosquito and midge breeding is likely to occur in wetlands.
- Cannot be placed on steep unstable slopes.
- Need for base flow or supplemental water if water level is to be maintained.
- Require a relatively large footprint
- Depending on volume and depth, pond designs may require approval from the State Division of Safety of Dams

**Design and Sizing Guidelines**

- Capture volume determined by local requirements or sized to treat 85% of the annual runoff volume.
- Outlet designed to discharge the capture volume over a period of 24 hours.
- Permanent pool volume equal to twice the water quality volume.
- Water depth not to exceed about 4 feet.
- Wetland vegetation occupying no more than 50% of surface area.
- Include energy dissipation in the inlet design and a sediment forebay to reduce resuspension of accumulated sediment and facilitate maintenance.
- A maintenance ramp should be included in the design to facilitate access to the forebay for maintenance activities and for vector surveillance and control.
- To facilitate vector surveillance and control activities, road access should be provided along at least one side of BMPs that are seven meters or less in width. Those BMPs that have shoreline-to-shoreline distances in excess of seven meters should have perimeter road access on both sides or be designed such that no parcel of water is greater than seven meters from the road.

## ***Construction/Inspection Considerations***

- In areas with porous soils an impermeable liner may be required to maintain an adequate permanent pool level.
- Outlet structures and piping should be installed with collars to prevent water from seeping through the fill and causing structural failure.
- Inspect facility after first large storm to determine whether the desired residence time has been achieved.

## **Performance**

The processes that impact the performance of constructed wetlands are essentially the same as those operating in wet ponds and similar pollutant reduction would be expected. One concern about the long-term performance of wetlands is associated with the vegetation density. If vegetation covers the majority of the facility, open water is confined to a few well defined channels. This can limit mixing of the stormwater runoff with the permanent pool and reduce the effectiveness as compared to a wet pond where a majority of the area is open water.

## **Siting Criteria**

Wet ponds are a widely applicable stormwater management practice and can be used over a broad range of storm frequencies and sizes, drainage areas and land use types. Although they have limited applicability in highly urbanized settings and in arid climates, they have few other restrictions. Constructed wetlands may be constructed on- or off-line and can be sited at feasible locations along established drainage ways with consistent base flow. An off-line design is preferred. Constructed wetlands are often utilized in smaller sub-watersheds and are particularly appropriate in areas with residential land uses or other areas where high nutrient loads are considered to be potential problems (e.g., golf courses).

Wetlands generally consume a fairly large area (typically 4-6 percent of the contributing drainage area), and these facilities are generally larger than wet ponds because the average depth is less.

Wet basin application is appropriate in the following settings: (1) where there is a need to achieve a reasonably high level of dissolved contaminant removal and/or sediment capture; (2) in small to medium-sized regional tributary areas with available open space and drainage areas greater than about 10 ha (25 ac.); (3) where base flow rates or other channel flow sources are relatively consistent year-round; (4) in settings where wildlife habitat benefits can be appreciated.

## **Additional Design Guidelines**

Constructed wetlands generally feature relatively uniformly vegetated areas with depths of one foot or less and open water areas (25-50% of the total area) no more than about 1.2 m (4 feet) deep, although design configuration options are relatively flexible. Wetland vegetation is comprised generally of a diverse, local aquatic plant species. Constructed wetlands can be designed on-line or off-line and generally serve relatively smaller drainage areas than wet ponds, although because of the shallow depths, the footprint of the facility will be larger than a wet pond serving the same tributary area.

The extended detention shallow wetland combines the treatment concepts of the dry extended detention pond and the constructed wetland. In this design, the water quality volume is detained above the permanent pool and released over 24 hours. In addition to increasing the residence time, which improves pollutant removal, this design also attenuates peak runoff rates. Consequently, this design alternative is recommended.

Pretreatment incorporates design features that help to settle out coarse sediment particles. By removing these particles from runoff before they reach the large permanent pool, the maintenance burden of the pond is reduced. In ponds, pretreatment is achieved with a sediment forebay. A sediment forebay is a small pool (typically about 10 percent of the volume of the permanent pool). Coarse particles remain trapped in the forebay, and maintenance is performed on this smaller pool, eliminating the need to dredge the entire pond.

Effective wetland design displays "complex microtopography." In other words, wetlands should have zones of both very shallow (<6 inches) and moderately shallow (<18 inches) wetlands incorporated, using underwater earth berms to create the zones. This design will provide a longer flow path through the wetland to encourage settling, and it provides two depth zones to encourage plant diversity.

There are a variety of sizing criteria for determining the volume of the permanent pool, mostly related to the water quality volume (i.e., the volume of water treated for pollutant removal) or the average storm size in a particular area. In addition, several theoretical approaches to determination of permanent pool volume have been developed. However, there is little empirical evidence to support these designs. Consequently, a simplified method (i.e., permanent pool volume equal to twice the water quality volume) is recommended.

Design features are also incorporated to ease maintenance of both the forebay and the main pool of ponds. Ponds should be designed with a maintenance access to the forebay to ease this relatively routine (every 5–7 year) maintenance activity. In addition, ponds should generally have a drain to draw down the pond for vegetation harvesting or the more infrequent dredging of the main cell of the pond.

### ***Summary of Design Recommendations***

- (1) Facility Sizing – The basin should be sized to hold the permanent pool as well as the required water quality volume. The volume of the permanent pool should equal twice the water quality volume.
- (2) Pond Configuration - The wet basin should be configured as a two stage facility with a sediment forebay and a main pool. The basins should be wedge-shaped, narrowest at the inlet and widest at the outlet. The minimum length to width ratio should be 1.5 where feasible. The depth in the center of the basin should be about 4 feet deep to prevent vegetation from encroaching on the pond open water surface.
- (3) Pond Side Slopes - Side slopes of the basin should be 3:1 (H:V) or flatter for grass stabilized slopes. Slopes steeper than 3:1 should be stabilized with an appropriate slope stabilization practice.
- (4) Sediment Forebay - A sediment forebay should be used to isolate gross sediments as they enter the facility and to simplify sediment removal. The sediment forebay



should consist of a separate cell formed by an earthen berm, gabion, or loose riprap wall. The forebay should be sized to contain 15 to 25% of the permanent pool volume and should be at least 3 feet deep. Exit velocities from the forebay should not be erosive. Direct maintenance access should be provided to the forebay. The bottom of the forebay may be hardened (concrete) to make sediment removal easier. A fixed vertical sediment depth marker should be installed in the forebay to measure sediment accumulation.

- (5) **Splitter Box** - When the pond is designed as an off-line facility, a splitter structure is used to isolate the water quality volume. The splitter box, or other flow diverting approach, should be designed to convey the 25-year event while providing at least 1.0 foot of freeboard along pond side slopes.
- (6) **Vegetation** - A plan should be prepared that indicates how aquatic and terrestrial areas will be vegetatively stabilized. Wetland vegetation elements should be placed along the aquatic bench or in the shallow portions of the permanent pool. The optimal elevation for planting of wetland vegetation is within 6 inches vertically of the normal pool elevation. A list of some wetland vegetation native to California is presented in the wet pond fact sheet.

## Maintenance

The amount of maintenance required for a constructed wetland is highly dependent on local regulatory agencies, particular health and vector control agencies. These agencies are often extremely concerned about the potential for mosquito breeding that may occur in the permanent pool.

Routine harvesting of vegetation may increase nutrient removal and prevent the export of these constituents from dead and dying plants falling in the water. A previous study (Faulkner and Richardson, 1991) documented dramatic reductions in nutrient removal after the first several years of operation and related it to the vegetation achieving a maximum density. Vegetation harvesting in the summer is recommended.

Typical maintenance activities and frequencies include:

- Schedule semiannual inspections for burrows, sediment accumulation, structural integrity of the outlet, and litter accumulation.
- Remove accumulated trash and debris in the basin at the middle and end of the wet season. The frequency of this activity may be altered to meet specific site conditions and aesthetic considerations.
- Where permitted by the Department of Fish and Game or other agency regulations, stock wet ponds/constructed wetlands regularly with mosquito fish (*Gambusia spp.*) to enhance natural mosquito and midge control.
- Introduce mosquito fish and maintain vegetation to assist their movements to control mosquitoes, as well as to provide access for vector inspectors. An annual vegetation harvest in summer appears to be optimum, in that it is after the bird breeding season, mosquito fish can provide the needed control until vegetation reaches late summer density, and there is

time for re-growth for runoff treatment purposes before the wet season. In certain cases, more frequent plant harvesting may be required by local vector control agencies.

- Maintain emergent and perimeter shoreline vegetation as well as site and road access to facilitate vector surveillance and control activities.
- Remove accumulated sediment in the forebay and regrade about every 5-7 years or when the accumulated sediment volume exceeds 10 percent of the basin volume. Sediment removal may not be required in the main pool area for as long as 20 years.

### Cost

#### ***Construction Cost***

Wetlands are relatively inexpensive storm water practices. Construction cost data for wetlands are rare, but one simplifying assumption is that they are typically about 25 percent more expensive than storm water ponds of an equivalent volume. Using this assumption, an equation developed by Brown and Schueler (1997) to estimate the cost of wet ponds can be modified to estimate the cost of storm water wetlands using the equation:

$$C = 30.6V^{0.705}$$

where:

C = Construction, design, and permitting cost;

V = Wetland volume needed to control the 10-year storm (ft<sup>3</sup>).

Using this equation, typical construction costs are the following:

\$ 57,100 for a 1 acre-foot facility

\$ 289,000 for a 10 acre-foot facility

\$ 1,470,000 for a 100 acre-foot facility

Wetlands consume about 3 to 5 percent of the land that drains to them, which is relatively high compared with other storm water management practices. In areas where land value is high, this may make wetlands an infeasible option.

#### ***Maintenance Cost***

For ponds, the annual cost of routine maintenance has typically been estimated at about 3 to 5 percent of the construction cost; however, the published literature is almost totally devoid of actual maintenance costs. Since ponds are long-lived facilities (typically longer than 20 years), major maintenance activities are unlikely to occur during a relatively short study.

#### **References and Sources of Additional Information**

Amalfi, F.A., R. Kadlec, R.L. Knight, G. O'Meara, W.K. Reisen, W.E. Walton, and R. Wass. 1999. A mosquito control strategy for the Tres Rios Demonstration Constructed Wetlands. CH2M Hill, Tempe, AZ, 140 pp.

Borden, R. C., J.L. Dorn, J.B. Stillman, and S.K. Liehr; 1996. *Evaluation of Ponds and Wetlands for Protection of Public Water Supplies*. Draft Report. Water Resources Research Institute of the University of North Carolina, Department of Civil Engineering, North Carolina State University, Raleigh, NC.

City of Austin, TX. 1991. *Design Guidelines for Water Quality Control Basins*. Public Works Department, Austin, TX.

Cullum, M. 1985. Stormwater Runoff Analysis at a Single Family Residential Site. Publication 85-1. University of Central Florida, Orlando, FL. pp. 247–256.

Dorothy, J.M., and K. Staker. 1990. A Preliminary Survey for Mosquito Breeding in Stormwater Retention Ponds in Three Maryland Counties. Mosquito Control, Maryland Department of Agriculture, College Park, MD. 5 pp.

Faulkner, S. and Richardson, C., 1991, Physical And Chemical Characteristics of Freshwater Wetland Soils, in *Constructed Wetlands for Wastewater Treatment*, ed. D. Hammer, Lewis Publishers, 831 pp.

Gain, W.S. 1996. *The Effects of Flow Path Modification on Water Quality Constituent Retention in an Urban Stormwater Detention Pond and Wetland System*. Water Resources Investigations Report 95-4297. U.S. Geological Survey, Tallahassee, FL.

Martin, E. 1988. Effectiveness Of An Urban Runoff Detention Pond/Wetland System. *Journal of Environmental Engineering* 114(4):810–827.

Maryland Department of the Environment (MDE). 2000. Maryland Stormwater Design Manual. <http://www.mde.state.md.us/environment/wma/stormwatermanual>.

McLean, J. 2000. Mosquitoes In Constructed Wetlands: A Management Bugaboo? In T.R. Schueler and H.K. Holland [eds.], *The Practice of Watershed Protection*. pp. 29-33. Center for Watershed Protection, Ellicott City, MD

Metzger, M. E., D. F. Messer, C. L. Beitia, C. M. Myers, and V. L. Kramer. 2002. The Dark Side of Stormwater Runoff Management: Disease Vectors Associated with Structural BMPs. *Stormwater* 3(2): 24-39.

Oberts, G.L. 1994. Performance Of Stormwater Ponds And Wetlands In Winter. *Watershed Protection Techniques* 1(2):64–68.

Oberts, G.L., and L. Wotzka. 1988. The Water Quality Performance Of A Detention Basin Wetland Treatment System In An Urban Area. In *Nonpoint Source Pollution: Economy, Policy, Management and Appropriate Technology*. American Water Resources Association, Middleburg, VA.

Santana, F.J., J.R. Wood, R.E. Parsons, and S.K. Chamberlain. 1994. Control Of Mosquito Breeding In Permitted Stormwater Systems. Sarasota County Mosquito Control and Southwest Florida Water Management District, Brooksville, FL., 46 pp.

Saunders, G. and M. Gilroy, 1997. Treatment of Nonpoint Source Pollution with Wetland/Aquatic Ecosystem Best Management Practices. Texas Water Development Board, Lower Colorado River Authority, Austin, TX.

Schueler, T. 1997a. Comparative Pollutant Removal Capability Of Urban BMPs: A Reanalysis. Watershed Protection Techniques 2(4):515–520.

Urbonas, B., J. Carlson, and B. Vang. 1994. Joint Pond-Wetland System in Colorado. Denver Urban Drainage and Flood Control District, Denver, CO.

Water Environment Federation and ASCE, 1998, Urban Runoff Quality Management, WEF Manual of Practice No. 23 and ASCE Manual and Report on Engineering Practice No. 87.

Wu, J. 1989. Evaluation of Detention Basin Performance in the Piedmont Region of North Carolina. Report No. 89-248. North Carolina Water Resources Research Institute, Raleigh, NC.

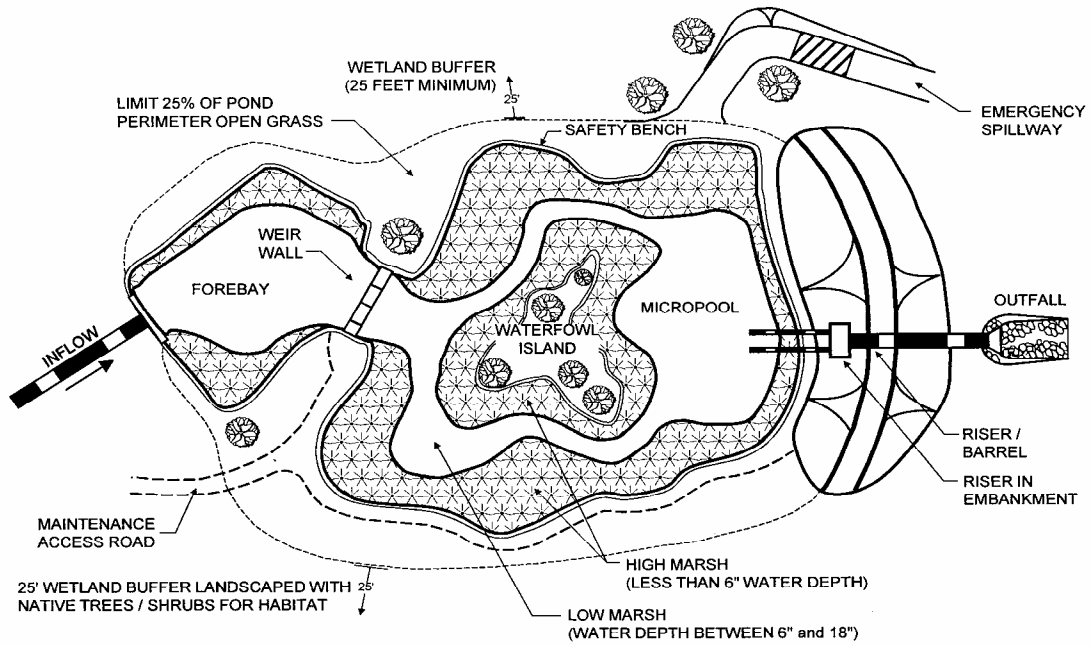

**PLAN VIEW**

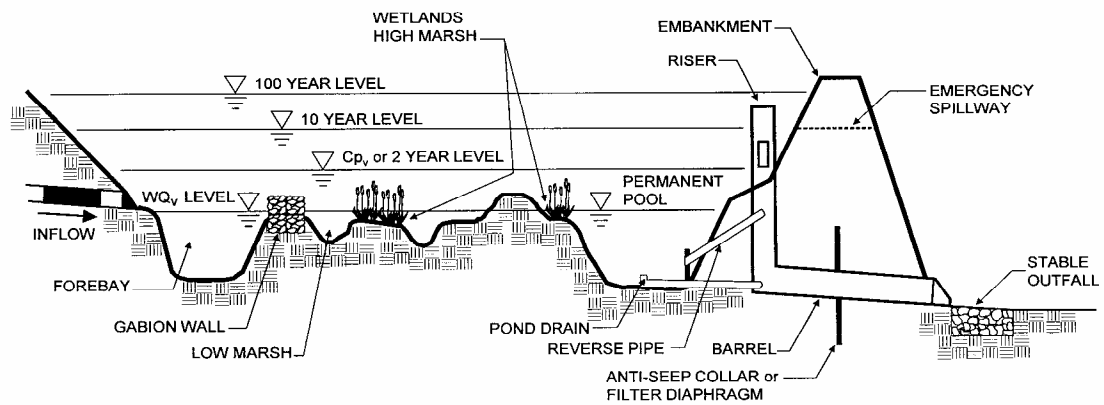

**PROFILE**





## Design Considerations

- Tributary Area
- Area Required
- Hydraulic Head

## Description

Dry extended detention ponds (a.k.a. dry ponds, extended detention basins, detention ponds, extended detention ponds) are basins whose outlets have been designed to detain the stormwater runoff from a water quality design storm for some minimum time (e.g., 48 hours) to allow particles and associated pollutants to settle. Unlike wet ponds, these facilities do not have a large permanent pool. They can also be used to provide flood control by including additional flood detention storage.

## California Experience

Caltrans constructed and monitored 5 extended detention basins in southern California with design drain times of 72 hours. Four of the basins were earthen, less costly and had substantially better load reduction because of infiltration that occurred, than the concrete basin. The Caltrans study reaffirmed the flexibility and performance of this conventional technology. The small headloss and few siting constraints suggest that these devices are one of the most applicable technologies for stormwater treatment.

## Advantages

- Due to the simplicity of design, extended detention basins are relatively easy and inexpensive to construct and operate.
- Extended detention basins can provide substantial capture of sediment and the toxics fraction associated with particulates.
- Widespread application with sufficient capture volume can provide significant control of channel erosion and enlargement caused by changes to flow frequency

## Targeted Constituents

<input checked="" type="checkbox"/>	Sediment	▲
<input checked="" type="checkbox"/>	Nutrients	●
<input checked="" type="checkbox"/>	Trash	■
<input checked="" type="checkbox"/>	Metals	▲
<input checked="" type="checkbox"/>	Bacteria	▲
<input checked="" type="checkbox"/>	Oil and Grease	▲
<input checked="" type="checkbox"/>	Organics	▲

### Legend (*Removal Effectiveness*)

- Low
- High
- ▲ Medium



relationships resulting from the increase of impervious cover in a watershed.

### Limitations

- Limitation of the diameter of the orifice may not allow use of extended detention in watersheds of less than 5 acres (would require an orifice with a diameter of less than 0.5 inches that would be prone to clogging).
- Dry extended detention ponds have only moderate pollutant removal when compared to some other structural stormwater practices, and they are relatively ineffective at removing soluble pollutants.
- Although wet ponds can increase property values, dry ponds can actually detract from the value of a home due to the adverse aesthetics of dry, bare areas and inlet and outlet structures.

### Design and Sizing Guidelines

- Capture volume determined by local requirements or sized to treat 85% of the annual runoff volume.
- Outlet designed to discharge the capture volume over a period of hours.
- Length to width ratio of at least 1.5:1 where feasible.
- Basin depths optimally range from 2 to 5 feet.
- Include energy dissipation in the inlet design to reduce resuspension of accumulated sediment.
- A maintenance ramp and perimeter access should be included in the design to facilitate access to the basin for maintenance activities and for vector surveillance and control.
- Use a draw down time of 48 hours in most areas of California. Draw down times in excess of 48 hours may result in vector breeding, and should be used only after coordination with local vector control authorities. Draw down times of less than 48 hours should be limited to BMP drainage areas with coarse soils that readily settle and to watersheds where warming may be determined to downstream fisheries.

### Construction/Inspection Considerations

- Inspect facility after first large to storm to determine whether the desired residence time has been achieved.
- When constructed with small tributary area, orifice sizing is critical and inspection should verify that flow through additional openings such as bolt holes does not occur.

### Performance

One objective of stormwater management practices can be to reduce the flood hazard associated with large storm events by reducing the peak flow associated with these storms. Dry extended detention basins can easily be designed for flood control, and this is actually the primary purpose of most detention ponds.



Dry extended detention basins provide moderate pollutant removal, provided that the recommended design features are incorporated. Although they can be effective at removing some pollutants through settling, they are less effective at removing soluble pollutants because of the absence of a permanent pool. Several studies are available on the effectiveness of dry extended detention ponds including one recently concluded by Caltrans (2002).

The load reduction is greater than the concentration reduction because of the substantial infiltration that occurs. Although the infiltration of stormwater is clearly beneficial to surface receiving waters, there is the potential for groundwater contamination. Previous research on the effects of incidental infiltration on groundwater quality indicated that the risk of contamination is minimal.

There were substantial differences in the amount of infiltration that were observed in the earthen basins during the Caltrans study. On average, approximately 40 percent of the runoff entering the unlined basins infiltrated and was not discharged. The percentage ranged from a high of about 60 percent to a low of only about 8 percent for the different facilities. Climatic conditions and local water table elevation are likely the principal causes of this difference. The least infiltration occurred at a site located on the coast where humidity is higher and the basin invert is within a few meters of sea level. Conversely, the most infiltration occurred at a facility located well inland in Los Angeles County where the climate is much warmer and the humidity is less, resulting in lower soil moisture content in the basin floor at the beginning of storms.

Vegetated detention basins appear to have greater pollutant removal than concrete basins. In the Caltrans study, the concrete basin exported sediment and associated pollutants during a number of storms. Export was not as common in the earthen basins, where the vegetation appeared to help stabilize the retained sediment.

## Siting Criteria

Dry extended detention ponds are among the most widely applicable stormwater management practices and are especially useful in retrofit situations where their low hydraulic head requirements allow them to be sited within the constraints of the existing storm drain system. In addition, many communities have detention basins designed for flood control. It is possible to modify these facilities to incorporate features that provide water quality treatment and/or channel protection. Although dry extended detention ponds can be applied rather broadly, designers need to ensure that they are feasible at the site in question. This section provides basic guidelines for siting dry extended detention ponds.

In general, dry extended detention ponds should be used on sites with a minimum area of 5 acres. With this size catchment area, the orifice size can be on the order of 0.5 inches. On smaller sites, it can be challenging to provide channel or water quality control because the orifice diameter at the outlet needed to control relatively small storms becomes very small and thus prone to clogging. In addition, it is generally more cost-effective to control larger drainage areas due to the economies of scale.

Extended detention basins can be used with almost all soils and geology, with minor design adjustments for regions of rapidly percolating soils such as sand. In these areas, extended detention ponds may need an impermeable liner to prevent ground water contamination.

The base of the extended detention facility should not intersect the water table. A permanently wet bottom may become a mosquito breeding ground. Research in Southwest Florida (Santana et al., 1994) demonstrated that intermittently flooded systems, such as dry extended detention ponds, produce more mosquitoes than other pond systems, particularly when the facilities remained wet for more than 3 days following heavy rainfall.

A study in Prince George's County, Maryland, found that stormwater management practices can increase stream temperatures (Galli, 1990). Overall, dry extended detention ponds increased temperature by about 5°F. In cold water streams, dry ponds should be designed to detain stormwater for a relatively short time (i.e., 24 hours) to minimize the amount of warming that occurs in the basin.

### Additional Design Guidelines

In order to enhance the effectiveness of extended detention basins, the dimensions of the basin must be sized appropriately. Merely providing the required storage volume will not ensure maximum constituent removal. By effectively configuring the basin, the designer will create a long flow path, promote the establishment of low velocities, and avoid having stagnant areas of the basin. To promote settling and to attain an appealing environment, the design of the basin should consider the length to width ratio, cross-sectional areas, basin slopes and pond configuration, and aesthetics (Young et al., 1996).

Energy dissipation structures should be included for the basin inlet to prevent resuspension of accumulated sediment. The use of stilling basins for this purpose should be avoided because the standing water provides a breeding area for mosquitoes.

Extended detention facilities should be sized to completely capture the water quality volume. A micropool is often recommended for inclusion in the design and one is shown in the schematic diagram. These small permanent pools greatly increase the potential for mosquito breeding and complicate maintenance activities; consequently, they are not recommended for use in California.

A large aspect ratio may improve the performance of detention basins; consequently, the outlets should be placed to maximize the flowpath through the facility. The ratio of flowpath length to width from the inlet to the outlet should be at least 1.5:1 (L:W) where feasible. Basin depths optimally range from 2 to 5 feet.

The facility's drawdown time should be regulated by an orifice or weir. In general, the outflow structure should have a trash rack or other acceptable means of preventing clogging at the entrance to the outflow pipes. The outlet design implemented by Caltrans in the facilities constructed in San Diego County used an outlet riser with orifices



**Figure 1**  
Example of Extended Detention Outlet Structure

sized to discharge the water quality volume, and the riser overflow height was set to the design storm elevation. A stainless steel screen was placed around the outlet riser to ensure that the orifices would not become clogged with debris. Sites either used a separate riser or broad crested weir for overflow of runoff for the 25 and greater year storms. A picture of a typical outlet is presented in Figure 1.

The outflow structure should be sized to allow for complete drawdown of the water quality volume in 72 hours. No more than 50% of the water quality volume should drain from the facility within the first 24 hours. The outflow structure can be fitted with a valve so that discharge from the basin can be halted in case of an accidental spill in the watershed.

### ***Summary of Design Recommendations***

- (1) **Facility Sizing** - The required water quality volume is determined by local regulations or the basin should be sized to capture and treat 85% of the annual runoff volume. See Section 5.5.1 of the handbook for a discussion of volume-based design.

**Basin Configuration** – A high aspect ratio may improve the performance of detention basins; consequently, the outlets should be placed to maximize the flowpath through the facility. The ratio of flowpath length to width from the inlet to the outlet should be at least 1.5:1 (L:W). The flowpath length is defined as the distance from the inlet to the outlet as measured at the surface. The width is defined as the mean width of the basin. Basin depths optimally range from 2 to 5 feet. The basin may include a sediment forebay to provide the opportunity for larger particles to settle out.

A micropool should not be incorporated in the design because of vector concerns. For online facilities, the principal and emergency spillways must be sized to provide 1.0 foot of freeboard during the 25-year event and to safely pass the flow from 100-year storm.

- (2) **Pond Side Slopes** - Side slopes of the pond should be 3:1 (H:V) or flatter for grass stabilized slopes. Slopes steeper than 3:1 (H:V) must be stabilized with an appropriate slope stabilization practice.
- (3) **Basin Lining** – Basins must be constructed to prevent possible contamination of groundwater below the facility.
- (4) **Basin Inlet** – Energy dissipation is required at the basin inlet to reduce resuspension of accumulated sediment and to reduce the tendency for short-circuiting.
- (5) **Outflow Structure** - The facility's drawdown time should be regulated by a gate valve or orifice plate. In general, the outflow structure should have a trash rack or other acceptable means of preventing clogging at the entrance to the outflow pipes.

The outflow structure should be sized to allow for complete drawdown of the water quality volume in 72 hours. No more than 50% of the water quality volume should drain from the facility within the first 24 hours. The outflow structure should be fitted with a valve so that discharge from the basin can be halted in case of an accidental spill in the watershed. This same valve also can be used to regulate the rate of discharge from the basin.

The discharge through a control orifice is calculated from:

$$Q = CA(2gH-H_0)^{0.5}$$

where:    Q = discharge (ft<sup>3</sup>/s)  
           C = orifice coefficient  
           A = area of the orifice (ft<sup>2</sup>)  
           g = gravitational constant (32.2)  
           H = water surface elevation (ft)  
           H<sub>0</sub> = orifice elevation (ft)

Recommended values for C are 0.66 for thin materials and 0.80 when the material is thicker than the orifice diameter. This equation can be implemented in spreadsheet form with the pond stage/volume relationship to calculate drain time. To do this, use the initial height of the water above the orifice for the water quality volume. Calculate the discharge and assume that it remains constant for approximately 10 minutes. Based on that discharge, estimate the total discharge during that interval and the new elevation based on the stage volume relationship. Continue to iterate until H is approximately equal to H<sub>0</sub>. When using multiple orifices the discharge from each is summed.

- (6) Splitter Box - When the pond is designed as an offline facility, a splitter structure is used to isolate the water quality volume. The splitter box, or other flow diverting approach, should be designed to convey the 25-year storm event while providing at least 1.0 foot of freeboard along pond side slopes.
- (7) Erosion Protection at the Outfall - For online facilities, special consideration should be given to the facility's outfall location. Flared pipe end sections that discharge at or near the stream invert are preferred. The channel immediately below the pond outfall should be modified to conform to natural dimensions, and lined with large stone riprap placed over filter cloth. Energy dissipation may be required to reduce flow velocities from the primary spillway to non-erosive velocities.
- (8) Safety Considerations - Safety is provided either by fencing of the facility or by managing the contours of the pond to eliminate dropoffs and other hazards. Earthen side slopes should not exceed 3:1 (H:V) and should terminate on a flat safety bench area. Landscaping can be used to impede access to the facility. The primary spillway opening must not permit access by small children. Outfall pipes above 48 inches in diameter should be fenced.

### Maintenance

Routine maintenance activity is often thought to consist mostly of sediment and trash and debris removal; however, these activities often constitute only a small fraction of the maintenance hours. During a recent study by Caltrans, 72 hours of maintenance was performed annually, but only a little over 7 hours was spent on sediment and trash removal. The largest recurring activity was vegetation management, routine mowing. The largest absolute number of hours was associated with vector control because of mosquito breeding that occurred in the stilling basins (example of standing water to be avoided) installed as energy dissipaters. In most cases, basic housekeeping practices such as removal of debris accumulations and vegetation

management to ensure that the basin dewater completely in 48-72 hours is sufficient to prevent creating mosquito and other vector habitats.

Consequently, maintenance costs should be estimated based primarily on the mowing frequency and the time required. Mowing should be done at least annually to avoid establishment of woody vegetation, but may need to be performed much more frequently if aesthetics are an important consideration.

Typical activities and frequencies include:

- Schedule semiannual inspection for the beginning and end of the wet season for standing water, slope stability, sediment accumulation, trash and debris, and presence of burrows.
- Remove accumulated trash and debris in the basin and around the riser pipe during the semiannual inspections. The frequency of this activity may be altered to meet specific site conditions.
- Trim vegetation at the beginning and end of the wet season and inspect monthly to prevent establishment of woody vegetation and for aesthetic and vector reasons.
- Remove accumulated sediment and regrade about every 10 years or when the accumulated sediment volume exceeds 10 percent of the basin volume. Inspect the basin each year for accumulated sediment volume.

## Cost

### **Construction Cost**

The construction costs associated with extended detention basins vary considerably. One recent study evaluated the cost of all pond systems (Brown and Schueler, 1997). Adjusting for inflation, the cost of dry extended detention ponds can be estimated with the equation:

$$C = 12.4V^{0.760}$$

where: C = Construction, design, and permitting cost, and  
V = Volume (ft<sup>3</sup>).

Using this equation, typical construction costs are:

\$ 41,600 for a 1 acre-foot pond

\$ 239,000 for a 10 acre-foot pond

\$ 1,380,000 for a 100 acre-foot pond

Interestingly, these costs are generally slightly higher than the predicted cost of wet ponds (according to Brown and Schueler, 1997) on a cost per total volume basis, which highlights the difficulty of developing reasonably accurate construction estimates. In addition, a typical facility constructed by Caltrans cost about \$160,000 with a capture volume of only 0.3 ac-ft.

An economic concern associated with dry ponds is that they might detract slightly from the value of adjacent properties. One study found that dry ponds can actually detract from the

perceived value of homes adjacent to a dry pond by between 3 and 10 percent (Emmerling-Dinovo, 1995).

**Maintenance Cost**

For ponds, the annual cost of routine maintenance is typically estimated at about 3 to 5 percent of the construction cost (EPA website). Alternatively, a community can estimate the cost of the maintenance activities outlined in the maintenance section. Table 1 presents the maintenance costs estimated by Caltrans based on their experience with five basins located in southern California. Again, it should be emphasized that the vast majority of hours are related to vegetation management (mowing).

<b>Table 1 Estimated Average Annual Maintenance Effort</b>			
<b>Activity</b>	<b>Labor Hours</b>	<b>Equipment &amp; Material (\$)</b>	<b>Cost</b>
Inspections	4	7	183
Maintenance	49	126	2282
Vector Control	0	0	0
Administration	3	0	132
Materials	-	535	535
<b>Total</b>	<b>56</b>	<b>\$668</b>	<b>\$3,132</b>

**References and Sources of Additional Information**

Brown, W., and T. Schueler. 1997. *The Economics of Stormwater BMPs in the Mid-Atlantic Region*. Prepared for Chesapeake Research Consortium. Edgewater, MD. Center for Watershed Protection. Ellicott City, MD.

Denver Urban Drainage and Flood Control District. 1992. *Urban Storm Drainage Criteria Manual—Volume 3: Best Management Practices*. Denver, CO.

Emmerling-Dinovo, C. 1995. Stormwater Detention Basins and Residential Locational Decisions. *Water Resources Bulletin* 31(3): 515–521

Galli, J. 1990. *Thermal Impacts Associated with Urbanization and Stormwater Management Best Management Practices*. Metropolitan Washington Council of Governments. Prepared for Maryland Department of the Environment, Baltimore, MD.

GKY, 1989, *Outlet Hydraulics of Extended Detention Facilities* for the Northern Virginia Planning District Commission.

MacRae, C. 1996. Experience from Morphological Research on Canadian Streams: Is Control of the Two-Year Frequency Runoff Event the Best Basis for Stream Channel Protection? In *Effects of Watershed Development and Management on Aquatic Ecosystems*. American Society of Civil Engineers. Edited by L. Roesner. Snowbird, UT. pp. 144–162.

Maryland Dept of the Environment, 2000, Maryland Stormwater Design Manual: Volumes 1 & 2, prepared by MDE and Center for Watershed Protection.  
<http://www.mde.state.md.us/environment/wma/stormwatermanual/index.html>

Metzger, M. E., D. F. Messer, C. L. Beitia, C. M. Myers, and V. L. Kramer. 2002. The Dark Side Of Stormwater Runoff Management: Disease Vectors Associated With Structural BMPs. *Stormwater* 3(2): 24-39.

Santana, F., J. Wood, R. Parsons, and S. Chamberlain. 1994. Control of Mosquito Breeding in Permitted Stormwater Systems. Prepared for Southwest Florida Water Management District, Brooksville, FL.

Schueler, T. 1997. Influence of Ground Water on Performance of Stormwater Ponds in Florida. *Watershed Protection Techniques* 2(4):525–528.

Watershed Management Institute (WMI). 1997. *Operation, Maintenance, and Management of Stormwater Management Systems*. Prepared for U.S. Environmental Protection Agency, Office of Water. Washington, DC.

Young, G.K., et al., 1996, *Evaluation and Management of Highway Runoff Water Quality*, Publication No. FHWA-PD-96-032, U.S. Department of Transportation, Federal Highway Administration, Office of Environment and Planning.

### ***Information Resources***

Center for Watershed Protection (CWP), Environmental Quality Resources, and Loiederman Associates. 1997. *Maryland Stormwater Design Manual*. Draft. Prepared for Maryland Department of the Environment, Baltimore, MD.

Center for Watershed Protection (CWP). 1997. *Stormwater BMP Design Supplement for Cold Climates*. Prepared for U.S. Environmental Protection Agency, Office of Wetlands, Oceans and Watersheds. Washington, DC.

U.S. Environmental Protection Agency (USEPA). 1993. *Guidance Specifying Management Measures for Sources of Nonpoint Pollution in Coastal Waters*. EPA-840-B-92-002. U.S. Environmental Protection Agency, Office of Water, Washington, DC.

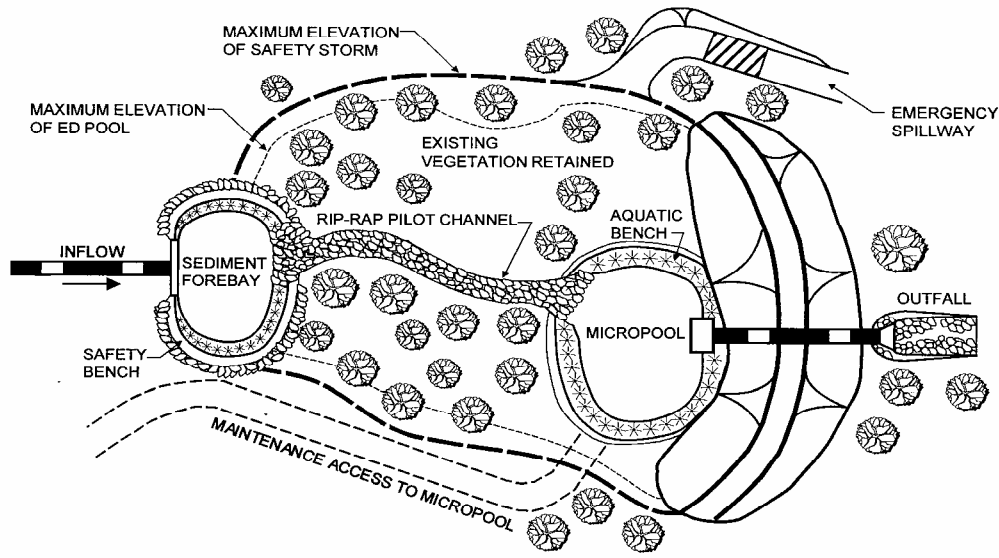

PLAN VIEW

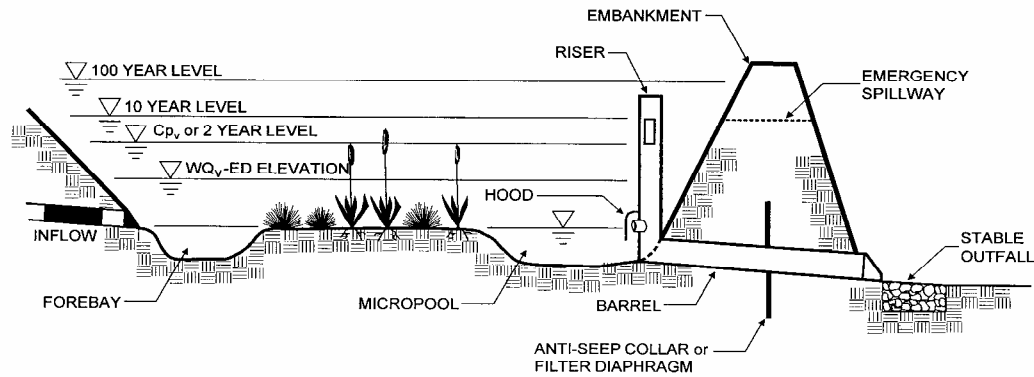

PROFILE

Schematic of an Extended Detention Basin (MDE, 2000)





## Design Considerations

- Tributary Area
- Area Required
- Slope
- Water Availability

## Description

Vegetated swales are open, shallow channels with vegetation covering the side slopes and bottom that collect and slowly convey runoff flow to downstream discharge points. They are designed to treat runoff through filtering by the vegetation in the channel, filtering through a subsoil matrix, and/or infiltration into the underlying soils. Swales can be natural or manmade. They trap particulate pollutants (suspended solids and trace metals), promote infiltration, and reduce the flow velocity of stormwater runoff. Vegetated swales can serve as part of a stormwater drainage system and can replace curbs, gutters and storm sewer systems.

## California Experience

Caltrans constructed and monitored six vegetated swales in southern California. These swales were generally effective in reducing the volume and mass of pollutants in runoff. Even in the areas where the annual rainfall was only about 10 inches/yr, the vegetation did not require additional irrigation. One factor that strongly affected performance was the presence of large numbers of gophers at most of the sites. The gophers created earthen mounds, destroyed vegetation, and generally reduced the effectiveness of the controls for TSS reduction.

## Advantages

- If properly designed, vegetated, and operated, swales can serve as an aesthetic, potentially inexpensive urban development or roadway drainage conveyance measure with significant collateral water quality benefits.

## Targeted Constituents

<input checked="" type="checkbox"/>	Sediment	▲
<input checked="" type="checkbox"/>	Nutrients	●
<input checked="" type="checkbox"/>	Trash	●
<input checked="" type="checkbox"/>	Metals	▲
<input checked="" type="checkbox"/>	Bacteria	●
<input checked="" type="checkbox"/>	Oil and Grease	▲
<input checked="" type="checkbox"/>	Organics	▲

### Legend (*Removal Effectiveness*)

- Low
- High
- ▲ Medium



- Roadside ditches should be regarded as significant potential swale/buffer strip sites and should be utilized for this purpose whenever possible.

### Limitations

- Can be difficult to avoid channelization.
- May not be appropriate for industrial sites or locations where spills may occur
- Grassed swales cannot treat a very large drainage area. Large areas may be divided and treated using multiple swales.
- A thick vegetative cover is needed for these practices to function properly.
- They are impractical in areas with steep topography.
- They are not effective and may even erode when flow velocities are high, if the grass cover is not properly maintained.
- In some places, their use is restricted by law: many local municipalities require curb and gutter systems in residential areas.
- Swales are more susceptible to failure if not properly maintained than other treatment BMPs.

### Design and Sizing Guidelines

- Flow rate based design determined by local requirements or sized so that 85% of the annual runoff volume is discharged at less than the design rainfall intensity.
- Swale should be designed so that the water level does not exceed 2/3rds the height of the grass or 4 inches, whichever is less, at the design treatment rate.
- Longitudinal slopes should not exceed 2.5%
- Trapezoidal channels are normally recommended but other configurations, such as parabolic, can also provide substantial water quality improvement and may be easier to mow than designs with sharp breaks in slope.
- Swales constructed in cut are preferred, or in fill areas that are far enough from an adjacent slope to minimize the potential for gopher damage. Do not use side slopes constructed of fill, which are prone to structural damage by gophers and other burrowing animals.
- A diverse selection of low growing, plants that thrive under the specific site, climatic, and watering conditions should be specified. Vegetation whose growing season corresponds to the wet season are preferred. Drought tolerant vegetation should be considered especially for swales that are not part of a regularly irrigated landscaped area.
- The width of the swale should be determined using Manning's Equation using a value of 0.25 for Manning's n.

## ***Construction/Inspection Considerations***

- Include directions in the specifications for use of appropriate fertilizer and soil amendments based on soil properties determined through testing and compared to the needs of the vegetation requirements.
- Install swales at the time of the year when there is a reasonable chance of successful establishment without irrigation; however, it is recognized that rainfall in a given year may not be sufficient and temporary irrigation may be used.
- If sod tiles must be used, they should be placed so that there are no gaps between the tiles; stagger the ends of the tiles to prevent the formation of channels along the swale or strip.
- Use a roller on the sod to ensure that no air pockets form between the sod and the soil.
- Where seeds are used, erosion controls will be necessary to protect seeds for at least 75 days after the first rainfall of the season.

## **Performance**

The literature suggests that vegetated swales represent a practical and potentially effective technique for controlling urban runoff quality. While limited quantitative performance data exists for vegetated swales, it is known that check dams, slight slopes, permeable soils, dense grass cover, increased contact time, and small storm events all contribute to successful pollutant removal by the swale system. Factors decreasing the effectiveness of swales include compacted soils, short runoff contact time, large storm events, frozen ground, short grass heights, steep slopes, and high runoff velocities and discharge rates.

Conventional vegetated swale designs have achieved mixed results in removing particulate pollutants. A study performed by the Nationwide Urban Runoff Program (NURP) monitored three grass swales in the Washington, D.C., area and found no significant improvement in urban runoff quality for the pollutants analyzed. However, the weak performance of these swales was attributed to the high flow velocities in the swales, soil compaction, steep slopes, and short grass height.

Another project in Durham, NC, monitored the performance of a carefully designed artificial swale that received runoff from a commercial parking lot. The project tracked 11 storms and concluded that particulate concentrations of heavy metals (Cu, Pb, Zn, and Cd) were reduced by approximately 50 percent. However, the swale proved largely ineffective for removing soluble nutrients.

The effectiveness of vegetated swales can be enhanced by adding check dams at approximately 17 meter (50 foot) increments along their length (See Figure 1). These dams maximize the retention time within the swale, decrease flow velocities, and promote particulate settling. Finally, the incorporation of vegetated filter strips parallel to the top of the channel banks can help to treat sheet flows entering the swale.

Only 9 studies have been conducted on all grassed channels designed for water quality (Table 1). The data suggest relatively high removal rates for some pollutants, but negative removals for some bacteria, and fair performance for phosphorus.

**Table 1 Grassed swale pollutant removal efficiency data**

Removal Efficiencies (% Removal)							
Study	TSS	TP	TN	NO <sub>3</sub>	Metals	Bacteria	Type
Caltrans 2002	77	8	67	66	83-90	-33	dry swales
Goldberg 1993	67.8	4.5	-	31.4	42-62	-100	grassed channel
Seattle Metro and Washington Department of Ecology 1992	60	45	-	-25	2-16	-25	grassed channel
Seattle Metro and Washington Department of Ecology, 1992	83	29	-	-25	46-73	-25	grassed channel
Wang et al., 1981	80	-	-	-	70-80	-	dry swale
Dorman et al., 1989	98	18	-	45	37-81	-	dry swale
Harper, 1988	87	83	84	80	88-90	-	dry swale
Kercher et al., 1983	99	99	99	99	99	-	dry swale
Harper, 1988.	81	17	40	52	37-69	-	wet swale
Koon, 1995	67	39	-	9	-35 to 6	-	wet swale

While it is difficult to distinguish between different designs based on the small amount of available data, grassed channels generally have poorer removal rates than wet and dry swales, although some swales appear to export soluble phosphorus (Harper, 1988; Koon, 1995). It is not clear why swales export bacteria. One explanation is that bacteria thrive in the warm swale soils.

**Siting Criteria**

The suitability of a swale at a site will depend on land use, size of the area serviced, soil type, slope, imperviousness of the contributing watershed, and dimensions and slope of the swale system (Schueler et al., 1992). In general, swales can be used to serve areas of less than 10 acres, with slopes no greater than 5 %. Use of natural topographic lows is encouraged and natural drainage courses should be regarded as significant local resources to be kept in use (Young et al., 1996).

**Selection Criteria (NCTCOG, 1993)**

- Comparable performance to wet basins
- Limited to treating a few acres
- Availability of water during dry periods to maintain vegetation
- Sufficient available land area

Research in the Austin area indicates that vegetated controls are effective at removing pollutants even when dormant. Therefore, irrigation is not required to maintain growth during dry periods, but may be necessary only to prevent the vegetation from dying.

The topography of the site should permit the design of a channel with appropriate slope and cross-sectional area. Site topography may also dictate a need for additional structural controls. Recommendations for longitudinal slopes range between 2 and 6 percent. Flatter slopes can be used, if sufficient to provide adequate conveyance. Steep slopes increase flow velocity, decrease detention time, and may require energy dissipating and grade check. Steep slopes also can be managed using a series of check dams to terrace the swale and reduce the slope to within acceptable limits. The use of check dams with swales also promotes infiltration.

## **Additional Design Guidelines**

Most of the design guidelines adopted for swale design specify a minimum hydraulic residence time of 9 minutes. This criterion is based on the results of a single study conducted in Seattle, Washington (Seattle Metro and Washington Department of Ecology, 1992), and is not well supported. Analysis of the data collected in that study indicates that pollutant removal at a residence time of 5 minutes was not significantly different, although there is more variability in that data. Therefore, additional research in the design criteria for swales is needed. Substantial pollutant removal has also been observed for vegetated controls designed solely for conveyance (Barrett et al, 1998); consequently, some flexibility in the design is warranted.

Many design guidelines recommend that grass be frequently mowed to maintain dense coverage near the ground surface. Recent research (Colwell et al., 2000) has shown mowing frequency or grass height has little or no effect on pollutant removal.

## ***Summary of Design Recommendations***

- 1) The swale should have a length that provides a minimum hydraulic residence time of at least 10 minutes. The maximum bottom width should not exceed 10 feet unless a dividing berm is provided. The depth of flow should not exceed 2/3rds the height of the grass at the peak of the water quality design storm intensity. The channel slope should not exceed 2.5%.
- 2) A design grass height of 6 inches is recommended.
- 3) Regardless of the recommended detention time, the swale should be not less than 100 feet in length.
- 4) The width of the swale should be determined using Manning's Equation, at the peak of the design storm, using a Manning's n of 0.25.
- 5) The swale can be sized as both a treatment facility for the design storm and as a conveyance system to pass the peak hydraulic flows of the 100-year storm if it is located "on-line." The side slopes should be no steeper than 3:1 (H:V).
- 6) Roadside ditches should be regarded as significant potential swale/buffer strip sites and should be utilized for this purpose whenever possible. If flow is to be introduced through curb cuts, place pavement slightly above the elevation of the vegetated areas. Curb cuts should be at least 12 inches wide to prevent clogging.
- 7) Swales must be vegetated in order to provide adequate treatment of runoff. It is important to maximize water contact with vegetation and the soil surface. For general purposes, select fine, close-growing, water-resistant grasses. If possible, divert runoff (other than necessary irrigation) during the period of vegetation

establishment. Where runoff diversion is not possible, cover graded and seeded areas with suitable erosion control materials.

### **Maintenance**

The useful life of a vegetated swale system is directly proportional to its maintenance frequency. If properly designed and regularly maintained, vegetated swales can last indefinitely. The maintenance objectives for vegetated swale systems include keeping up the hydraulic and removal efficiency of the channel and maintaining a dense, healthy grass cover.

Maintenance activities should include periodic mowing (with grass never cut shorter than the design flow depth), weed control, watering during drought conditions, reseeding of bare areas, and clearing of debris and blockages. Cuttings should be removed from the channel and disposed in a local composting facility. Accumulated sediment should also be removed manually to avoid concentrated flows in the swale. The application of fertilizers and pesticides should be minimal.

Another aspect of a good maintenance plan is repairing damaged areas within a channel. For example, if the channel develops ruts or holes, it should be repaired utilizing a suitable soil that is properly tamped and seeded. The grass cover should be thick; if it is not, reseed as necessary. Any standing water removed during the maintenance operation must be disposed to a sanitary sewer at an approved discharge location. Residuals (e.g., silt, grass cuttings) must be disposed in accordance with local or State requirements. Maintenance of grassed swales mostly involves maintenance of the grass or wetland plant cover. Typical maintenance activities are summarized below:

- Inspect swales at least twice annually for erosion, damage to vegetation, and sediment and debris accumulation preferably at the end of the wet season to schedule summer maintenance and before major fall runoff to be sure the swale is ready for winter. However, additional inspection after periods of heavy runoff is desirable. The swale should be checked for debris and litter, and areas of sediment accumulation.
- Grass height and mowing frequency may not have a large impact on pollutant removal. Consequently, mowing may only be necessary once or twice a year for safety or aesthetics or to suppress weeds and woody vegetation.
- Trash tends to accumulate in swale areas, particularly along highways. The need for litter removal is determined through periodic inspection, but litter should always be removed prior to mowing.
- Sediment accumulating near culverts and in channels should be removed when it builds up to 75 mm (3 in.) at any spot, or covers vegetation.
- Regularly inspect swales for pools of standing water. Swales can become a nuisance due to mosquito breeding in standing water if obstructions develop (e.g. debris accumulation, invasive vegetation) and/or if proper drainage slopes are not implemented and maintained.

## Cost

### ***Construction Cost***

Little data is available to estimate the difference in cost between various swale designs. One study (SWRPC, 1991) estimated the construction cost of grassed channels at approximately \$0.25 per ft<sup>2</sup>. This price does not include design costs or contingencies. Brown and Schueler (1997) estimate these costs at approximately 32 percent of construction costs for most stormwater management practices. For swales, however, these costs would probably be significantly higher since the construction costs are so low compared with other practices. A more realistic estimate would be a total cost of approximately \$0.50 per ft<sup>2</sup>, which compares favorably with other stormwater management practices.

Table 2 Swale Cost Estimate (SEWRPC, 1991)

Component	Unit	Extent	Unit Cost			Total Cost		
			Low	Moderate	High	Low	Moderate	High
Mobilization / Demobilization-Light	Swale	1	\$107	\$274	\$441	\$107	\$274	\$441
Site Preparation								
Clearing <sup>b</sup> .....	Acres	0.5	\$2,200	\$3,800	\$5,400	\$1,100	\$1,900	\$2,700
Grubbing <sup>c</sup> .....	Acres	0.25	\$3,800	\$5,200	\$6,600	\$950	\$1,300	\$1,650
General Excavation <sup>d</sup> .....	Yd <sup>3</sup>	372	\$2,10	\$3,70	\$5,30	\$781	\$1,376	\$1,972
Level and Till <sup>e</sup> .....	Yd <sup>2</sup>	1,210	\$0.20	\$0.35	\$0.50	\$242	\$424	\$605
Sites Development								
Salvaged Topsoil	Yd <sup>2</sup>	1,210	\$0.40	\$1.00	\$1.60	\$484	\$1,210	\$1,936
Seed and Mulch <sup>f</sup> .....	Yd <sup>2</sup>	1,210	\$1.20	\$2.40	\$3.60	\$1,452	\$2,904	\$4,356
Sods <sup>g</sup> .....								
Subtotal	--	--	--	--	--	\$5,116	\$9,388	\$13,660
Contingencies	Swale	1	25%	25%	25%	\$1,279	\$2,347	\$3,415
Total	--	--	--	--	--	\$6,395	\$11,735	\$17,075

Source: (SEWRPC, 1991)

Note: Mobilization/demobilization refers to the organization and planning involved in establishing a vegetative swale.

<sup>a</sup> Swale has a bottom width of 1.0 foot, a top width of 10 feet with 1:3 side slopes, and a 1,000-foot length.

<sup>b</sup> Area cleared = (top width + 10 feet) x swale length.

<sup>c</sup> Area grubbed = (top width x swale length).

<sup>d</sup> Volume excavated = (0.67 x top width x swale depth) x swale length (parabolic cross-section).

<sup>e</sup> Area tilled = (top width +  $\frac{8}{3}$ (swale depth)<sup>2</sup>) x swale length (parabolic cross-section).

<sup>f</sup> Area seeded = area cleared x 0.5.

<sup>g</sup> Area sodded = area cleared x 0.5.



Table 3 Estimated Maintenance Costs (SEWRPC, 1991)

Component	Unit Cost	Swale Size (Depth and Top Width)		Comment
		1.5 Foot Depth, One-Foot Bottom Width, 10-Foot Top Width	3-Foot Depth, 3-Foot Bottom Width, 21-Foot Top Width	
Lawn Mowing	\$0.85 / 1,000 ft <sup>2</sup> / mowing	\$0.14 / linear foot	\$0.21 / linear foot	Lawn maintenance area = (top width + 10 feet) x length. Mow eight times per year
General Lawn Care	\$9.00 / 1,000 ft <sup>2</sup> / year	\$0.18 / linear foot	\$0.28 / linear foot	Lawn maintenance area = (top width + 10 feet) x length
Swale Debris and Litter Removal	\$0.10 / linear foot / year	\$0.10 / linear foot	\$0.10 / linear foot	-
Grass Reseeding with Mulch and Fertilizer	\$0.30 / yd <sup>2</sup>	\$0.01 / linear foot	\$0.01 / linear foot	Area revegetated equals 1% of lawn maintenance area per year
Program Administration and Swale Inspection	\$0.15 / linear foot / year, plus \$25 / inspection	\$0.15 / linear foot	\$0.15 / linear foot	Inspect four times per year
<b>Total</b>	--	<b>\$0.58 / linear foot</b>	<b>\$0.75 / linear foot</b>	--

**Maintenance Cost**

Caltrans (2002) estimated the expected annual maintenance cost for a swale with a tributary area of approximately 2 ha at approximately \$2,700. Since almost all maintenance consists of mowing, the cost is fundamentally a function of the mowing frequency. Unit costs developed by SEWRPC are shown in Table 3. In many cases vegetated channels would be used to convey runoff and would require periodic mowing as well, so there may be little additional cost for the water quality component. Since essentially all the activities are related to vegetation management, no special training is required for maintenance personnel.

**References and Sources of Additional Information**

Barrett, Michael E., Walsh, Patrick M., Malina, Joseph F., Jr., Charbeneau, Randall J, 1998, "Performance of vegetative controls for treating highway runoff," *ASCE Journal of Environmental Engineering*, Vol. 124, No. 11, pp. 1121-1128.

Brown, W., and T. Schueler. 1997. *The Economics of Stormwater BMPs in the Mid-Atlantic Region*. Prepared for the Chesapeake Research Consortium, Edgewater, MD, by the Center for Watershed Protection, Ellicott City, MD.

Center for Watershed Protection (CWP). 1996. *Design of Stormwater Filtering Systems*. Prepared for the Chesapeake Research Consortium, Solomons, MD, and USEPA Region V, Chicago, IL, by the Center for Watershed Protection, Ellicott City, MD.

Colwell, Shanti R., Horner, Richard R., and Booth, Derek B., 2000. *Characterization of Performance Predictors and Evaluation of Mowing Practices in Biofiltration Swales*. Report to King County Land And Water Resources Division and others by Center for Urban Water Resources Management, Department of Civil and Environmental Engineering, University of Washington, Seattle, WA

Dorman, M.E., J. Hartigan, R.F. Steg, and T. Quasebarth. 1989. *Retention, Detention and Overland Flow for Pollutant Removal From Highway Stormwater Runoff. Vol. 1*. FHWA/RD 89/202. Federal Highway Administration, Washington, DC.

Goldberg. 1993. *Dayton Avenue Swale Biofiltration Study*. Seattle Engineering Department, Seattle, WA.

Harper, H. 1988. *Effects of Stormwater Management Systems on Groundwater Quality*. Prepared for Florida Department of Environmental Regulation, Tallahassee, FL, by Environmental Research and Design, Inc., Orlando, FL.

Kercher, W.C., J.C. Landon, and R. Massarelli. 1983. Grassy swales prove cost-effective for water pollution control. *Public Works*, 16: 53–55.

Koon, J. 1995. *Evaluation of Water Quality Ponds and Swales in the Issaquah/East Lake Sammamish Basins*. King County Surface Water Management, Seattle, WA, and Washington Department of Ecology, Olympia, WA.

Metzger, M. E., D. F. Messer, C. L. Beitia, C. M. Myers, and V. L. Kramer. 2002. The Dark Side Of Stormwater Runoff Management: Disease Vectors Associated With Structural BMPs. *Stormwater* 3(2): 24-39.

Oakland, P.H. 1983. An evaluation of stormwater pollutant removal

through grassed swale treatment. In *Proceedings of the International Symposium of Urban Hydrology, Hydraulics and Sediment Control*, Lexington, KY. pp. 173–182.

Occoquan Watershed Monitoring Laboratory. 1983. Final Report: *Metropolitan Washington Urban Runoff Project*. Prepared for the Metropolitan Washington Council of Governments, Washington, DC, by the Occoquan Watershed Monitoring Laboratory, Manassas, VA.

Pitt, R., and J. McLean. 1986. *Toronto Area Watershed Management Strategy Study: Humber River Pilot Watershed Project*. Ontario Ministry of Environment, Toronto, ON.

Schueler, T. 1997. Comparative Pollutant Removal Capability of Urban BMPs: A reanalysis. *Watershed Protection Techniques* 2(2):379–383.

Seattle Metro and Washington Department of Ecology. 1992. *Biofiltration Swale Performance: Recommendations and Design Considerations*. Publication No. 657. Water Pollution Control Department, Seattle, WA.

Southeastern Wisconsin Regional Planning Commission (SWRPC). 1991. *Costs of Urban Nonpoint Source Water Pollution Control Measures*. Technical report no. 31. Southeastern Wisconsin Regional Planning Commission, Waukesha, WI.

U.S. EPA, 1999, Stormwater Fact Sheet: Vegetated Swales, Report # 832-F-99-006 <http://www.epa.gov/owm/mtb/vegswale.pdf>, Office of Water, Washington DC.

Wang, T., D. Spyridakis, B. Mar, and R. Horner. 1981. *Transport, Deposition and Control of Heavy Metals in Highway Runoff*. FHWA-WA-RD-39-10. University of Washington, Department of Civil Engineering, Seattle, WA.

Washington State Department of Transportation, 1995, *Highway Runoff Manual*, Washington State Department of Transportation, Olympia, Washington.

Welborn, C., and J. Veenhuis. 1987. *Effects of Runoff Controls on the Quantity and Quality of Urban Runoff in Two Locations in Austin, TX*. USGS Water Resources Investigations Report No. 87-4004. U.S. Geological Survey, Reston, VA.

Yousef, Y., M. Wanielista, H. Harper, D. Pearce, and R. Tolbert. 1985. *Best Management Practices: Removal of Highway Contaminants By Roadside Swales*. University of Central Florida and Florida Department of Transportation, Orlando, FL.

Yu, S., S. Barnes, and V. Gerde. 1993. *Testing of Best Management Practices for Controlling Highway Runoff*. FHWA/VA-93-R16. Virginia Transportation Research Council, Charlottesville, VA.

## **Information Resources**

Maryland Department of the Environment (MDE). 2000. *Maryland Stormwater Design Manual*. [www.mde.state.md.us/environment/wma/stormwatermanual](http://www.mde.state.md.us/environment/wma/stormwatermanual). Accessed May 22, 2001.

Reeves, E. 1994. Performance and Condition of Biofilters in the Pacific Northwest. *Watershed Protection Techniques* 1(3):117–119.

Seattle Metro and Washington Department of Ecology. 1992. *Biofiltration Swale Performance. Recommendations and Design Considerations*. Publication No. 657. Seattle Metro and Washington Department of Ecology, Olympia, WA.

USEPA 1993. *Guidance Specifying Management Measures for Sources of Nonpoint Pollution in Coastal Waters*. EPA-840-B-92-002. U.S. Environmental Protection Agency, Office of Water. Washington, DC.

Watershed Management Institute (WMI). 1997. *Operation, Maintenance, and Management of Stormwater Management Systems*. Prepared for U.S. Environmental Protection Agency, Office of Water. Washington, DC, by the Watershed Management Institute, Ingleside, MD.

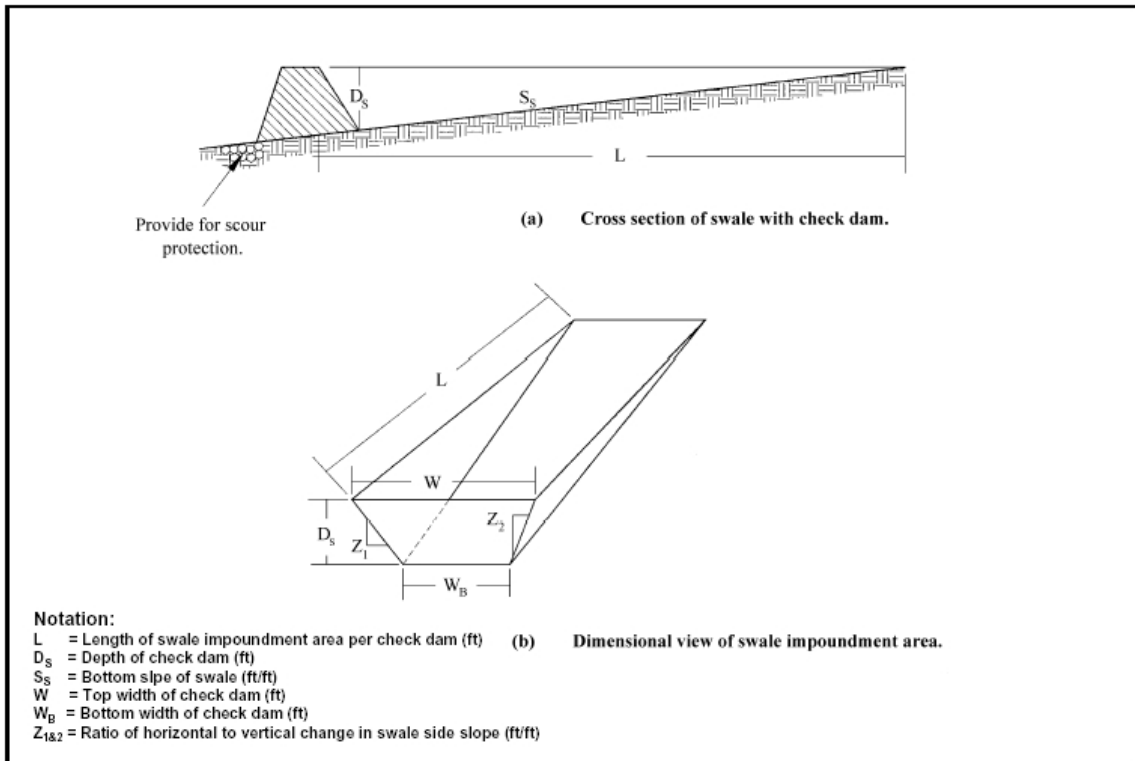





## Description

Grassed buffer strips (vegetated filter strips, filter strips, and grassed filters) are vegetated surfaces that are designed to treat sheet flow from adjacent surfaces. Filter strips function by slowing runoff velocities and allowing sediment and other pollutants to settle and by providing some infiltration into underlying soils. Filter strips were originally used as an agricultural treatment practice and have more recently evolved into an urban practice. With proper design and maintenance, filter strips can provide relatively high pollutant removal. In addition, the public views them as landscaped amenities and not as stormwater infrastructure. Consequently, there is little resistance to their use.

## California Experience

Caltrans constructed and monitored three vegetated buffer strips in southern California and is currently evaluating their performance at eight additional sites statewide. These strips were generally effective in reducing the volume and mass of pollutants in runoff. Even in the areas where the annual rainfall was only about 10 inches/yr, the vegetation did not require additional irrigation. One factor that strongly affected performance was the presence of large numbers of gophers at most of the southern California sites. The gophers created earthen mounds, destroyed vegetation, and generally reduced the effectiveness of the controls for TSS reduction.

## Advantages

- Buffers require minimal maintenance activity (generally just erosion prevention and mowing).
- If properly designed, vegetated, and operated, buffer strips can provide reliable water quality benefits in conjunction with high aesthetic appeal.

## Design Considerations

- Tributary Area
- Slope
- Water Availability
- Aesthetics

## Targeted Constituents

<input checked="" type="checkbox"/>	Sediment	■
<input checked="" type="checkbox"/>	Nutrients	●
<input checked="" type="checkbox"/>	Trash	▲
<input checked="" type="checkbox"/>	Metals	■
<input checked="" type="checkbox"/>	Bacteria	●
<input checked="" type="checkbox"/>	Oil and Grease	■
<input checked="" type="checkbox"/>	Organics	▲

### Legend (*Removal Effectiveness*)

- Low
- High
- ▲ Medium



- Flow characteristics and vegetation type and density can be closely controlled to maximize BMP effectiveness.
- Roadside shoulders act as effective buffer strips when slope and length meet criteria described below.

### Limitations

- May not be appropriate for industrial sites or locations where spills may occur.
- Buffer strips cannot treat a very large drainage area.
- A thick vegetative cover is needed for these practices to function properly.
- Buffer or vegetative filter length must be adequate and flow characteristics acceptable or water quality performance can be severely limited.
- Vegetative buffers may not provide treatment for dissolved constituents except to the extent that flows across the vegetated surface are infiltrated into the soil profile.
- This technology does not provide significant attenuation of the increased volume and flow rate of runoff during intense rain events.

### Design and Sizing Guidelines

- Maximum length (in the direction of flow towards the buffer) of the tributary area should be 60 feet.
- Slopes should not exceed 15%.
- Minimum length (in direction of flow) is 15 feet.
- Width should be the same as the tributary area.
- Either grass or a diverse selection of other low growing, drought tolerant, native vegetation should be specified. Vegetation whose growing season corresponds to the wet season is preferred.

### ***Construction/Inspection Considerations***

- Include directions in the specifications for use of appropriate fertilizer and soil amendments based on soil properties determined through testing and compared to the needs of the vegetation requirements.
- Install strips at the time of the year when there is a reasonable chance of successful establishment without irrigation; however, it is recognized that rainfall in a given year may not be sufficient and temporary irrigation may be required.
- If sod tiles must be used, they should be placed so that there are no gaps between the tiles; stagger the ends of the tiles to prevent the formation of channels along the strip.
- Use a roller on the sod to ensure that no air pockets form between the sod and the soil.



- Where seeds are used, erosion controls will be necessary to protect seeds for at least 75 days after the first rainfall of the season.

## Performance

Vegetated buffer strips tend to provide somewhat better treatment of stormwater runoff than swales and have fewer tendencies for channelization or erosion. Table 1 documents the pollutant removal observed in a recent study by Caltrans (2002) based on three sites in southern California. The column labeled “Significance” is the probability that the mean influent and effluent EMCs are not significantly different based on an analysis of variance.

The removal of sediment and dissolved metals was comparable to that observed in much more complex controls. Reduction in nitrogen was not significant and all of the sites exported phosphorus for the entire study period. This may have been the result of using salt grass, a warm weather species that is dormant during the wet season, and which leaches phosphorus when dormant.

Another Caltrans study (unpublished) of vegetated highway shoulders as buffer strips also found substantial reductions often within a very short distance of the edge of pavement. Figure 1 presents a box and whisker plot of the concentrations of TSS in highway runoff after traveling various distances (shown in meters) through a vegetated filter strip with a slope of about 10%. One can see that the TSS median concentration reaches an irreducible minimum concentration of about 20 mg/L within 5 meters of the pavement edge.

**Table 1 Pollutant Reduction in a Vegetated Buffer Strip**

Constituent	Mean EMC		Removal %	Significance P
	Influent (mg/L)	Effluent (mg/L)		
TSS	119	31	74	<0.000
NO <sub>3</sub> -N	0.67	0.58	13	0.367
TKN-N	2.50	2.10	16	0.542
Total N <sup>a</sup>	3.17	2.68	15	-
Dissolved P	0.15	0.46	-206	0.047
Total P	0.42	0.62	-52	0.035
Total Cu	0.058	0.009	84	<0.000
Total Pb	0.046	0.006	88	<0.000
Total Zn	0.245	0.055	78	<0.000
Dissolved Cu	0.029	0.007	77	0.004
Dissolved Pb	0.004	0.002	66	0.006
Dissolved Zn	0.099	0.035	65	<0.000

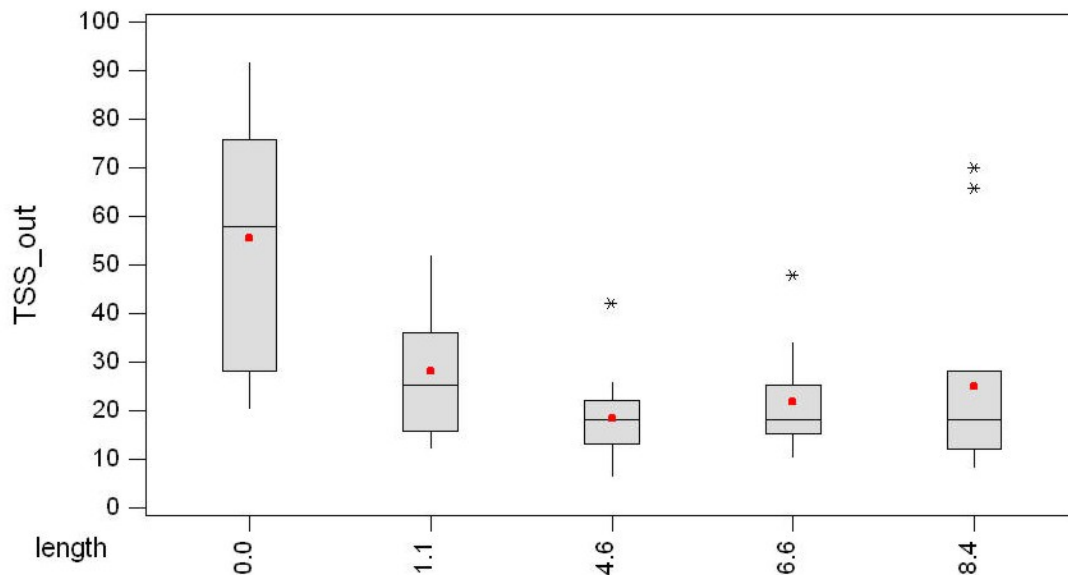

Filter strips also exhibit good removal of litter and other floatables because the water depth in these systems is well below the vegetation height and consequently these materials are not easily transported through them. Unfortunately little attenuation of peak runoff rates and volumes (particularly for larger events) is normally observed, depending on the soil properties. Therefore it may be prudent to follow the strips with another practice that can reduce flooding and channel erosion downstream.

### Siting Criteria

The use of buffer strips is limited to gently sloping areas where the vegetative cover is robust and diffuse, and where shallow flow characteristics are possible. The practical water quality benefits can be effectively eliminated with the occurrence of significant erosion or when flow concentration occurs across the vegetated surface. Slopes should not exceed 15 percent or be less than 1 percent. The vegetative surface should extend across the full width of the area being drained. The upstream boundary of the filter should be located contiguous to the developed area. Use of a level spreading device (vegetated berm, sawtooth concrete border, rock trench, etc) to facilitate overland sheet flow is not normally recommended because of maintenance considerations and the potential for standing water.

Filter strips are applicable in most regions, but are restricted in some situations because they consume a large amount of space relative to other practices. Filter strips are best suited to treating runoff from roads and highways, roof downspouts, small parking lots, and pervious surfaces. They are also ideal components of the "outer zone" of a stream buffer or as pretreatment to a structural practice. In arid areas, however, the cost of irrigating the grass on the practice will most likely outweigh its water quality benefits, although aesthetic considerations may be sufficient to overcome this constraint. Filter strips are generally impractical in ultra-urban areas where little pervious surface exists.

Some cold water species, such as trout, are sensitive to changes in temperature. While some treatment practices, such as wet ponds, can warm stormwater substantially, filter strips do not

are not expected to increase stormwater temperatures. Thus, these practices are good for protection of cold-water streams.

Filter strips should be separated from the ground water by between 2 and 4 ft to prevent contamination and to ensure that the filter strip does not remain wet between storms.

## Additional Design Guidelines

Filter strips appear to be a minimal design practice because they are basically no more than a grassed slope. In general the slope of the strip should not exceed 15fc% and the strip should be at least 15 feet long to provide water quality treatment. Both the top and toe of the slope should be as flat as possible to encourage sheet flow and prevent erosion. The top of the strip should be installed 2-5 inches below the adjacent pavement, so that vegetation and sediment accumulation at the edge of the strip does not prevent runoff from entering.

A major question that remains unresolved is how large the drainage area to a strip can be. Research has conclusively demonstrated that these are effective on roadside shoulders, where the contributing area is about twice the buffer area. They have also been installed on the perimeter of large parking lots where they performed fairly effectively; however much lower slopes may be needed to provide adequate water quality treatment.

The filter area should be densely vegetated with a mix of erosion-resistant plant species that effectively bind the soil. Native or adapted grasses, shrubs, and trees are preferred because they generally require less fertilizer and are more drought resistant than exotic plants. Runoff flow velocities should not exceed about 1 fps across the vegetated surface.

For engineered vegetative strips, the facility surface should be graded flat prior to placement of vegetation. Initial establishment of vegetation requires attentive care including appropriate watering, fertilization, and prevention of excessive flow across the facility until vegetation completely covers the area and is well established. Use of a permanent irrigation system may help provide maximal water quality performance.

In cold climates, filter strips provide a convenient area for snow storage and treatment. If used for this purpose, vegetation in the filter strip should be salt-tolerant (e.g., creeping bentgrass), and a maintenance schedule should include the removal of sand built up at the bottom of the slope. In arid or semi-arid climates, designers should specify drought-tolerant grasses to minimize irrigation requirements.

## Maintenance

Filter strips require mainly vegetation management; therefore little special training is needed for maintenance crews. Typical maintenance activities and frequencies include:

- Inspect strips at least twice annually for erosion or damage to vegetation, preferably at the end of the wet season to schedule summer maintenance and before major fall run-off to be sure the strip is ready for winter. However, additional inspection after periods of heavy run-off is most desirable. The strip should be checked for debris and litter and areas of sediment accumulation.
- Recent research on biofiltration swales, but likely applicable to strips (Colwell et al., 2000), indicates that grass height and mowing frequency have little impact on pollutant removal;

consequently, mowing may only be necessary once or twice a year for safety and aesthetics or to suppress weeds and woody vegetation.

- Trash tends to accumulate in strip areas, particularly along highways. The need for litter removal should be determined through periodic inspection but litter should always be removed prior to mowing.
- Regularly inspect vegetated buffer strips for pools of standing water. Vegetated buffer strips can become a nuisance due to mosquito breeding in level spreaders (unless designed to dewater completely in 48-72 hours), in pools of standing water if obstructions develop (e.g. debris accumulation, invasive vegetation), and/or if proper drainage slopes are not implemented and maintained.

### Cost

#### **Construction Cost**

Little data is available on the actual construction costs of filter strips. One rough estimate can be the cost of seed or sod, which is approximately 30¢ per ft<sup>2</sup> for seed or 70¢ per ft<sup>2</sup> for sod. This amounts to between \$13,000 and \$30,000 per acre of filter strip. This cost is relatively high compared with other treatment practices. However, the grassed area used as a filter strip may have been seeded or sodded even if it were not used for treatment. In these cases, the only additional cost is the design. Typical maintenance costs are about \$350/acre/year (adapted from SWRPC, 1991). This cost is relatively inexpensive and, again, might overlap with regular landscape maintenance costs.

The true cost of filter strips is the land they consume. In some situations this land is available as wasted space beyond back yards or adjacent to roadsides, but this practice is cost-prohibitive when land prices are high and land could be used for other purposes.

#### **Maintenance Cost**

Maintenance of vegetated buffer strips consists mainly of vegetation management (mowing, irrigation if needed, weeding) and litter removal. Consequently the costs are quite variable depending on the frequency of these activities and the local labor rate.

### References and Sources of Additional Information

Caltrans, 2002, BMP Retrofit Pilot Program Proposed Final Report, Rpt. CTSW-RT-01-050, California Dept. of Transportation, Sacramento, CA.

Center for Watershed Protection (CWP). 1996. *Design of Stormwater Filtering Systems*. Prepared for Chesapeake Research Consortium, Solomons, MD, and EPA Region V, Chicago, IL.

Desbonette, A., P. Pogue, V. Lee, and N. Wolff. 1994. *Vegetated Buffers in the Coastal Zone: A Summary Review and Bibliography*. Coastal Resources Center. University of Rhode Island, Kingston, RI.

Magette, W., R. Brinsfield, R. Palmer and J. Wood. 1989. Nutrient and Sediment Removal by Vegetated Filter Strips. *Transactions of the American Society of Agricultural Engineers* 32(2): 663–667.

Metzger, M. E., D. F. Messer, C. L. Beitia, C. M. Myers, and V. L. Kramer. 2002. The Dark Side Of Stormwater Runoff Management: Disease Vectors Associated With Structural BMPs. *Stormwater* 3(2): 24-39.

Southeastern Wisconsin Regional Planning Commission (SWRPC). 1991. *Costs of Urban Nonpoint Source Water Pollution Control Measures*. Technical report no. 31. Southeastern Wisconsin Regional Planning Commission, Waukesha, WI.

Yu, S., S. Barnes and V. Gerde. 1993. *Testing of Best Management Practices for Controlling Highway Runoff*. FHWA/VA 93-R16. Virginia Transportation Research Council, Charlottesville, VA.

### ***Information Resources***

Center for Watershed Protection (CWP). 1997. *Stormwater BMP Design Supplement for Cold Climates*. Prepared for U.S. Environmental Protection Agency Office of Wetlands, Oceans and Watersheds. Washington, DC.

Maryland Department of the Environment (MDE). 2000. *Maryland Stormwater Design Manual*. <http://www.mde.state.md.us/environment/wma/stormwatermanual>. Accessed May 22, 2001.

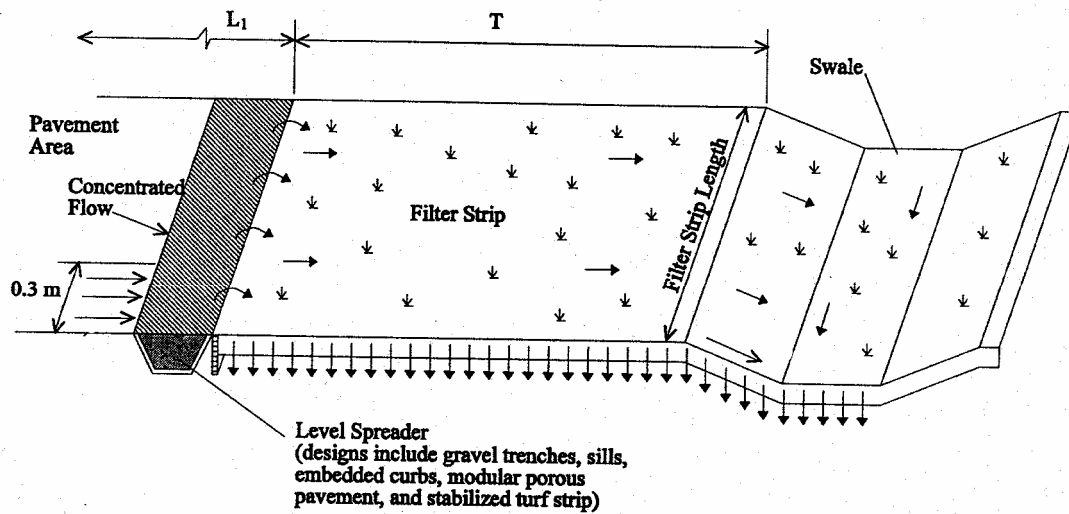



## Design Considerations

- Soil for Infiltration
- Tributary Area
- Slope
- Aesthetics
- Environmental Side-effects

## Description

The bioretention best management practice (BMP) functions as a soil and plant-based filtration device that removes pollutants through a variety of physical, biological, and chemical treatment processes. These facilities normally consist of a grass buffer strip, sand bed, ponding area, organic layer or mulch layer, planting soil, and plants. The runoff's velocity is reduced by passing over or through buffer strip and subsequently distributed evenly along a ponding area. Exfiltration of the stored water in the bioretention area planting soil into the underlying soils occurs over a period of days.

## California Experience

None documented. Bioretention has been used as a stormwater BMP since 1992. In addition to Prince George's County, MD and Alexandria, VA, bioretention has been used successfully at urban and suburban areas in Montgomery County, MD; Baltimore County, MD; Chesterfield County, VA; Prince William County, VA; Smith Mountain Lake State Park, VA; and Cary, NC.

## Advantages

- Bioretention provides stormwater treatment that enhances the quality of downstream water bodies by temporarily storing runoff in the BMP and releasing it over a period of four days to the receiving water (EPA, 1999).
- The vegetation provides shade and wind breaks, absorbs noise, and improves an area's landscape.

## Limitations

- The bioretention BMP is not recommended for areas with slopes greater than 20% or where mature tree removal would

## Targeted Constituents

<input checked="" type="checkbox"/>	Sediment	■
<input checked="" type="checkbox"/>	Nutrients	▲
<input checked="" type="checkbox"/>	Trash	■
<input checked="" type="checkbox"/>	Metals	■
<input checked="" type="checkbox"/>	Bacteria	■
<input checked="" type="checkbox"/>	Oil and Grease	■
<input checked="" type="checkbox"/>	Organics	■

### Legend (Removal Effectiveness)

- Low
- High
- ▲ Medium



be required since clogging may result, particularly if the BMP receives runoff with high sediment loads (EPA, 1999).

- Bioretention is not a suitable BMP at locations where the water table is within 6 feet of the ground surface and where the surrounding soil stratum is unstable.
- By design, bioretention BMPs have the potential to create very attractive habitats for mosquitoes and other vectors because of highly organic, often heavily vegetated areas mixed with shallow water.
- In cold climates the soil may freeze, preventing runoff from infiltrating into the planting soil.

### **Design and Sizing Guidelines**

- The bioretention area should be sized to capture the design storm runoff.
- In areas where the native soil permeability is less than 0.5 in/hr an underdrain should be provided.
- Recommended minimum dimensions are 15 feet by 40 feet, although the preferred width is 25 feet. Excavated depth should be 4 feet.
- Area should drain completely within 72 hours.
- Approximately 1 tree or shrub per 50 ft<sup>2</sup> of bioretention area should be included.
- Cover area with about 3 inches of mulch.

### ***Construction/Inspection Considerations***

Bioretention area should not be established until contributing watershed is stabilized.

### **Performance**

Bioretention removes stormwater pollutants through physical and biological processes, including adsorption, filtration, plant uptake, microbial activity, decomposition, sedimentation and volatilization (EPA, 1999). Adsorption is the process whereby particulate pollutants attach to soil (e.g., clay) or vegetation surfaces. Adequate contact time between the surface and pollutant must be provided for in the design of the system for this removal process to occur. Thus, the infiltration rate of the soils must not exceed those specified in the design criteria or pollutant removal may decrease. Pollutants removed by adsorption include metals, phosphorus, and hydrocarbons. Filtration occurs as runoff passes through the bioretention area media, such as the sand bed, ground cover, and planting soil.

Common particulates removed from stormwater include particulate organic matter, phosphorus, and suspended solids. Biological processes that occur in wetlands result in pollutant uptake by plants and microorganisms in the soil. Plant growth is sustained by the uptake of nutrients from the soils, with woody plants locking up these nutrients through the seasons. Microbial activity within the soil also contributes to the removal of nitrogen and organic matter. Nitrogen is removed by nitrifying and denitrifying bacteria, while aerobic bacteria are responsible for the decomposition of the organic matter. Microbial processes require oxygen and can result in depleted oxygen levels if the bioretention area is not adequately



aerated. Sedimentation occurs in the swale or ponding area as the velocity slows and solids fall out of suspension.

The removal effectiveness of bioretention has been studied during field and laboratory studies conducted by the University of Maryland (Davis et al, 1998). During these experiments, synthetic stormwater runoff was pumped through several laboratory and field bioretention areas to simulate typical storm events in Prince George's County, MD. Removal rates for heavy metals and nutrients are shown in Table 1.

<b>Pollutant</b>	<b>Removal Rate</b>
Total Phosphorus	70-83%
Metals (Cu, Zn, Pb)	93-98%
TKN	68-80%
Total Suspended Solids	90%
Organics	90%
Bacteria	90%

Results for both the laboratory and field experiments were similar for each of the pollutants analyzed. Doubling or halving the influent pollutant levels had little effect on the effluent pollutants concentrations (Davis et al, 1998).

The microbial activity and plant uptake occurring in the bioretention area will likely result in higher removal rates than those determined for infiltration BMPs.

### **Siting Criteria**

Bioretention BMPs are generally used to treat stormwater from impervious surfaces at commercial, residential, and industrial areas (EPA, 1999). Implementation of bioretention for stormwater management is ideal for median strips, parking lot islands, and swales. Moreover, the runoff in these areas can be designed to either divert directly into the bioretention area or convey into the bioretention area by a curb and gutter collection system.

The best location for bioretention areas is upland from inlets that receive sheet flow from graded areas and at areas that will be excavated (EPA, 1999). In order to maximize treatment effectiveness, the site must be graded in such a way that minimizes erosive conditions as sheet flow is conveyed to the treatment area. Locations where a bioretention area can be readily incorporated into the site plan without further environmental damage are preferred. Furthermore, to effectively minimize sediment loading in the treatment area, bioretention only should be used in stabilized drainage areas.

### Additional Design Guidelines

The layout of the bioretention area is determined after site constraints such as location of utilities, underlying soils, existing vegetation, and drainage are considered (EPA, 1999). Sites with loamy sand soils are especially appropriate for bioretention because the excavated soil can be backfilled and used as the planting soil, thus eliminating the cost of importing planting soil.

The use of bioretention may not be feasible given an unstable surrounding soil stratum, soils with clay content greater than 25 percent, a site with slopes greater than 20 percent, and/or a site with mature trees that would be removed during construction of the BMP.

Bioretention can be designed to be off-line or on-line of the existing drainage system (EPA, 1999). The drainage area for a bioretention area should be between 0.1 and 0.4 hectares (0.25 and 1.0 acres). Larger drainage areas may require multiple bioretention areas. Furthermore, the maximum drainage area for a bioretention area is determined by the expected rainfall intensity and runoff rate. Stabilized areas may erode when velocities are greater than 5 feet per second (1.5 meter per second). The designer should determine the potential for erosive conditions at the site.

The size of the bioretention area, which is a function of the drainage area and the runoff generated from the area is sized to capture the water quality volume.

The recommended minimum dimensions of the bioretention area are 15 feet (4.6 meters) wide by 40 feet (12.2 meters) long, where the minimum width allows enough space for a dense, randomly-distributed area of trees and shrubs to become established. Thus replicating a natural forest and creating a microclimate, thereby enabling the bioretention area to tolerate the effects of heat stress, acid rain, runoff pollutants, and insect and disease infestations which landscaped areas in urban settings typically are unable to tolerate. The preferred width is 25 feet (7.6 meters), with a length of twice the width. Essentially, any facilities wider than 20 feet (6.1 meters) should be twice as long as they are wide, which promotes the distribution of flow and decreases the chances of concentrated flow.

In order to provide adequate storage and prevent water from standing for excessive periods of time the ponding depth of the bioretention area should not exceed 6 inches (15 centimeters). Water should not be left to stand for more than 72 hours. A restriction on the type of plants that can be used may be necessary due to some plants' water intolerance. Furthermore, if water is left standing for longer than 72 hours mosquitoes and other insects may start to breed.

The appropriate planting soil should be backfilled into the excavated bioretention area. Planting soils should be sandy loam, loamy sand, or loam texture with a clay content ranging from 10 to 25 percent.

Generally the soil should have infiltration rates greater than 0.5 inches (1.25 centimeters) per hour, which is typical of sandy loams, loamy sands, or loams. The pH of the soil should range between 5.5 and 6.5, where pollutants such as organic nitrogen and phosphorus can be adsorbed by the soil and microbial activity can flourish. Additional requirements for the planting soil include a 1.5 to 3 percent organic content and a maximum 500 ppm concentration of soluble salts.

Soil tests should be performed for every 500 cubic yards (382 cubic meters) of planting soil, with the exception of pH and organic content tests, which are required only once per bioretention area (EPA, 1999). Planting soil should be 4 inches (10.1 centimeters) deeper than the bottom of the largest root ball and 4 feet (1.2 meters) altogether. This depth will provide adequate soil for the plants' root systems to become established, prevent plant damage due to severe wind, and provide adequate moisture capacity. Most sites will require excavation in order to obtain the recommended depth.

Planting soil depths of greater than 4 feet (1.2 meters) may require additional construction practices such as shoring measures (EPA, 1999). Planting soil should be placed in 18 inches or greater lifts and lightly compacted until the desired depth is reached. Since high canopy trees may be destroyed during maintenance the bioretention area should be vegetated to resemble a terrestrial forest community ecosystem that is dominated by understory trees. Three species each of both trees and shrubs are recommended to be planted at a rate of 2500 trees and shrubs per hectare (1000 per acre). For instance, a 15 foot (4.6 meter) by 40 foot (12.2 meter) bioretention area (600 square feet or 55.75 square meters) would require 14 trees and shrubs. The shrub-to-tree ratio should be 2:1 to 3:1.

Trees and shrubs should be planted when conditions are favorable. Vegetation should be watered at the end of each day for fourteen days following its planting. Plant species tolerant of pollutant loads and varying wet and dry conditions should be used in the bioretention area.

The designer should assess aesthetics, site layout, and maintenance requirements when selecting plant species. Adjacent non-native invasive species should be identified and the designer should take measures, such as providing a soil breach to eliminate the threat of these species invading the bioretention area. Regional landscaping manuals should be consulted to ensure that the planting of the bioretention area meets the landscaping requirements established by the local authorities. The designers should evaluate the best placement of vegetation within the bioretention area. Plants should be placed at irregular intervals to replicate a natural forest. Trees should be placed on the perimeter of the area to provide shade and shelter from the wind. Trees and shrubs can be sheltered from damaging flows if they are placed away from the path of the incoming runoff. In cold climates, species that are more tolerant to cold winds, such as evergreens, should be placed in windier areas of the site.

Following placement of the trees and shrubs, the ground cover and/or mulch should be established. Ground cover such as grasses or legumes can be planted at the beginning of the growing season. Mulch should be placed immediately after trees and shrubs are planted. Two to 3 inches (5 to 7.6 cm) of commercially-available fine shredded hardwood mulch or shredded hardwood chips should be applied to the bioretention area to protect from erosion.

## Maintenance

The primary maintenance requirement for bioretention areas is that of inspection and repair or replacement of the treatment area's components. Generally, this involves nothing more than the routine periodic maintenance that is required of any landscaped area. Plants that are appropriate for the site, climatic, and watering conditions should be selected for use in the bioretention cell. Appropriately selected plants will aid in reducing fertilizer, pesticide, water, and overall maintenance requirements. Bioretention system components should blend over time through plant and root growth, organic decomposition, and the development of a natural

soil horizon. These biologic and physical processes over time will lengthen the facility's life span and reduce the need for extensive maintenance.

Routine maintenance should include a biannual health evaluation of the trees and shrubs and subsequent removal of any dead or diseased vegetation (EPA, 1999). Diseased vegetation should be treated as needed using preventative and low-toxic measures to the extent possible. BMPs have the potential to create very attractive habitats for mosquitoes and other vectors because of highly organic, often heavily vegetated areas mixed with shallow water. Routine inspections for areas of standing water within the BMP and corrective measures to restore proper infiltration rates are necessary to prevent creating mosquito and other vector habitat. In addition, bioretention BMPs are susceptible to invasion by aggressive plant species such as cattails, which increase the chances of water standing and subsequent vector production if not routinely maintained.

In order to maintain the treatment area's appearance it may be necessary to prune and weed. Furthermore, mulch replacement is suggested when erosion is evident or when the site begins to look unattractive. Specifically, the entire area may require mulch replacement every two to three years, although spot mulching may be sufficient when there are random void areas. Mulch replacement should be done prior to the start of the wet season.

New Jersey's Department of Environmental Protection states in their bioretention systems standards that accumulated sediment and debris removal (especially at the inflow point) will normally be the primary maintenance function. Other potential tasks include replacement of dead vegetation, soil pH regulation, erosion repair at inflow points, mulch replenishment, unclogging the underdrain, and repairing overflow structures. There is also the possibility that the cation exchange capacity of the soils in the cell will be significantly reduced over time. Depending on pollutant loads, soils may need to be replaced within 5-10 years of construction (LID, 2000).

## Cost

### ***Construction Cost***

Construction cost estimates for a bioretention area are slightly greater than those for the required landscaping for a new development (EPA, 1999). A general rule of thumb (Coffman, 1999) is that residential bioretention areas average about \$3 to \$4 per square foot, depending on soil conditions and the density and types of plants used. Commercial, industrial and institutional site costs can range between \$10 to \$40 per square foot, based on the need for control structures, curbing, storm drains and underdrains.

Retrofitting a site typically costs more, averaging \$6,500 per bioretention area. The higher costs are attributed to the demolition of existing concrete, asphalt, and existing structures and the replacement of fill material with planting soil. The costs of retrofitting a commercial site in Maryland, Kettering Development, with 15 bioretention areas were estimated at \$111,600.

In any bioretention area design, the cost of plants varies substantially and can account for a significant portion of the expenditures. While these cost estimates are slightly greater than those of typical landscaping treatment (due to the increased number of plantings, additional soil excavation, backfill material, use of underdrains etc.), those landscaping expenses that would be required regardless of the bioretention installation should be subtracted when determining the net cost.

Perhaps of most importance, however, the cost savings compared to the use of traditional structural stormwater conveyance systems makes bioretention areas quite attractive financially. For example, the use of bioretention can decrease the cost required for constructing stormwater conveyance systems at a site. A medical office building in Maryland was able to reduce the amount of storm drain pipe that was needed from 800 to 230 feet - a cost savings of \$24,000 (PGDER, 1993). And a new residential development spent a total of approximately \$100,000 using bioretention cells on each lot instead of nearly \$400,000 for the traditional stormwater ponds that were originally planned (Rappahanock, ). Also, in residential areas, stormwater management controls become a part of each property owner's landscape, reducing the public burden to maintain large centralized facilities.

### ***Maintenance Cost***

The operation and maintenance costs for a bioretention facility will be comparable to those of typical landscaping required for a site. Costs beyond the normal landscaping fees will include the cost for testing the soils and may include costs for a sand bed and planting soil.

### **References and Sources of Additional Information**

Coffman, L.S., R. Goo and R. Frederick, 1999: Low impact development: an innovative alternative approach to stormwater management. Proceedings of the 26th Annual Water Resources Planning and Management Conference ASCE, June 6-9, Tempe, Arizona.

Davis, A.P., Shokouhian, M., Sharma, H. and Minami, C., "Laboratory Study of Biological Retention (Bioretention) for Urban Stormwater Management," *Water Environ. Res.*, 73(1), 5-14 (2001).

Davis, A.P., Shokouhian, M., Sharma, H., Minami, C., and Winogradoff, D. "Water Quality Improvement through Bioretention: Lead, Copper, and Zinc," *Water Environ. Res.*, accepted for publication, August 2002.

Kim, H., Seagren, E.A., and Davis, A.P., "Engineered Bioretention for Removal of Nitrate from Stormwater Runoff," *WEFTEC 2000 Conference Proceedings on CDROM Research Symposium, Nitrogen Removal*, Session 19, Anaheim CA, October 2000.

Hsieh, C.-h. and Davis, A.P. "Engineering Bioretention for Treatment of Urban Stormwater Runoff," *Watersheds 2002, Proceedings on CDROM Research Symposium*, Session 15, Ft. Lauderdale, FL, Feb. 2002.

Prince George's County Department of Environmental Resources (PGDER), 1993. Design Manual for Use of *Bioretention in Stormwater Management*. Division of Environmental Management, Watershed Protection Branch. Landover, MD.

U.S. EPA Office of Water, 1999. Stormwater Technology Fact Sheet: Bioretention. EPA 832-F-99-012.

Weinstein, N. Davis, A.P. and Veeramachaneni, R. "Low Impact Development (LID) Stormwater Management Approach for the Control of Diffuse Pollution from Urban Roadways," *5th International Conference Diffuse/Nonpoint Pollution and Watershed Management Proceedings*, C.S. Melching and Emre Alp, Eds. 2001 International Water Association

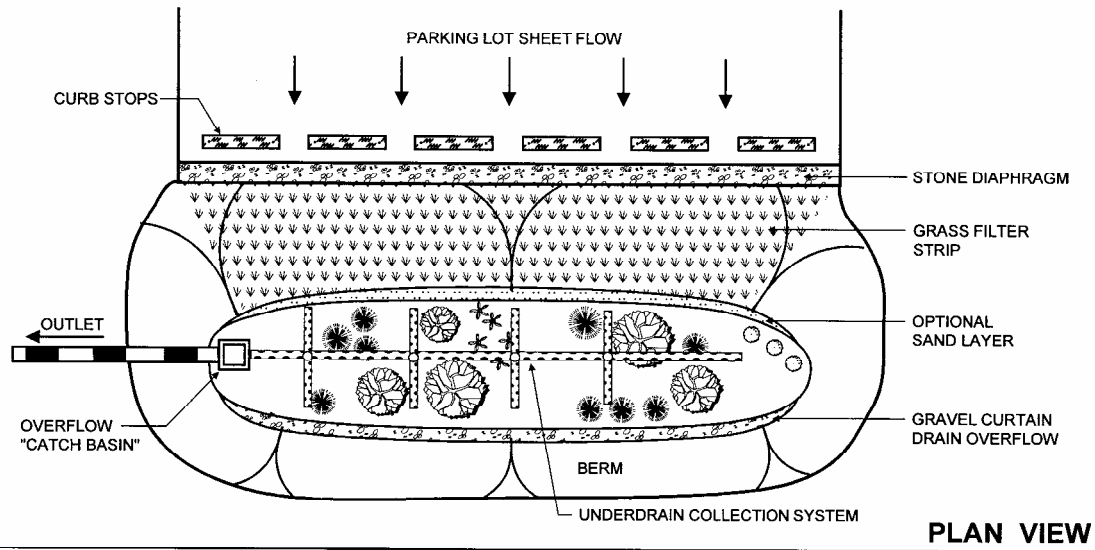

PLAN VIEW

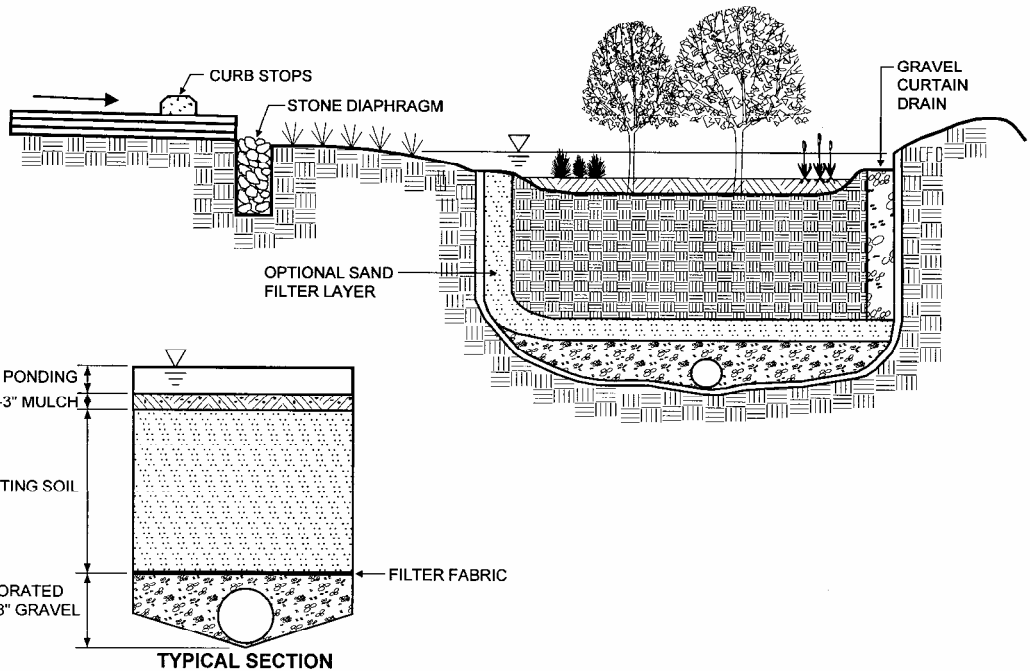

PROFILE

Schematic of a Bioretention Facility (MDE, 2000)



## Design Considerations

- Aesthetics
- Hydraulic Head

## Description

Stormwater media filters are usually two-chambered including a pretreatment settling basin and a filter bed filled with sand or other absorptive filtering media. As stormwater flows into the first chamber, large particles settle out, and then finer particles and other pollutants are removed as stormwater flows through the filtering media in the second chamber. There are a number of design variations including the Austin sand filter, Delaware sand filter, and multi-chambered treatment train (MCTT).

## California Experience

Caltrans constructed and monitored five Austin sand filters, two MCTTs, and one Delaware design in southern California. Pollutant removal was very similar for each of the designs; however operational and maintenance aspects were quite different. The Delaware filter and MCTT maintain permanent pools and consequently mosquito management was a critical issue, while the Austin style which is designed to empty completely between storms was less affected. Removal of the top few inches of sand was required at 3 of the Austin filters and the Delaware filter during the third year of operation; consequently, sizing of the filter bed is a critical design factor for establishing maintenance frequency.

## Advantages

- Relatively high pollutant removal, especially for sediment and associated pollutants.
- Widespread application with sufficient capture volume can provide significant control of channel erosion and enlargement caused by changes to flow frequency relationships resulting from the increase of impervious cover in a watershed.

## Limitations

## Targeted Constituents

<input checked="" type="checkbox"/>	Sediment	■
<input checked="" type="checkbox"/>	Nutrients	●
<input checked="" type="checkbox"/>	Trash	■
<input checked="" type="checkbox"/>	Metals	■
<input checked="" type="checkbox"/>	Bacteria	▲
<input checked="" type="checkbox"/>	Oil and Grease	■
<input checked="" type="checkbox"/>	Organics	■

### Legend (*Removal Effectiveness*)

- Low
- High
- ▲ Medium



- More expensive to construct than many other BMPs.
- May require more maintenance than some other BMPs depending upon the sizing of the filter bed.
- Generally require more hydraulic head to operate properly (minimum 4 feet).
- High solids loads will cause the filter to clog.
- Work best for relatively small, impervious watersheds.
- Filters in residential areas can present aesthetic and safety problems if constructed with vertical concrete walls.
- Certain designs (e.g., MCTT and Delaware filter) maintain permanent sources of standing water where mosquito and midge breeding is likely to occur.

#### **Design and Sizing Guidelines**

- Capture volume determined by local requirements or sized to treat 85% of the annual runoff volume.
- Filter bed sized to discharge the capture volume over a period of 48 hours.
- Filter bed 18 inches thick above underdrain system.
- Include energy dissipation in the inlet design to reduce resuspension of accumulated sediment.
- A maintenance ramp should be included in the design to facilitate access to the sedimentation and filter basins for maintenance activities (particularly for the Austin design).
- Designs that utilize covered sedimentation and filtration basins should be accessible to vector control personnel via access doors to facilitate vector surveillance and controlling the basins if needed.

#### ***Construction/Inspection Considerations***

- Tributary area should be completely stabilized before media is installed to prevent premature clogging.

#### **Performance**

The pollutant removal performance of media filters and other stormwater BMPs is generally characterized by the percent reduction in the influent load. This method implies a relationship between influent and effluent concentrations. For instance, it would be expected that a device that is reported to achieve a 75% reduction would have an effluent concentration equal to 25% of the influent concentrations. Recent work in California (Caltrans, 2002) on various sand filter designs indicates that this model for characterizing performance is inadequate. Figure 4 presents a graph relating influent and effluent TSS concentrations for the Austin full sedimentation design.



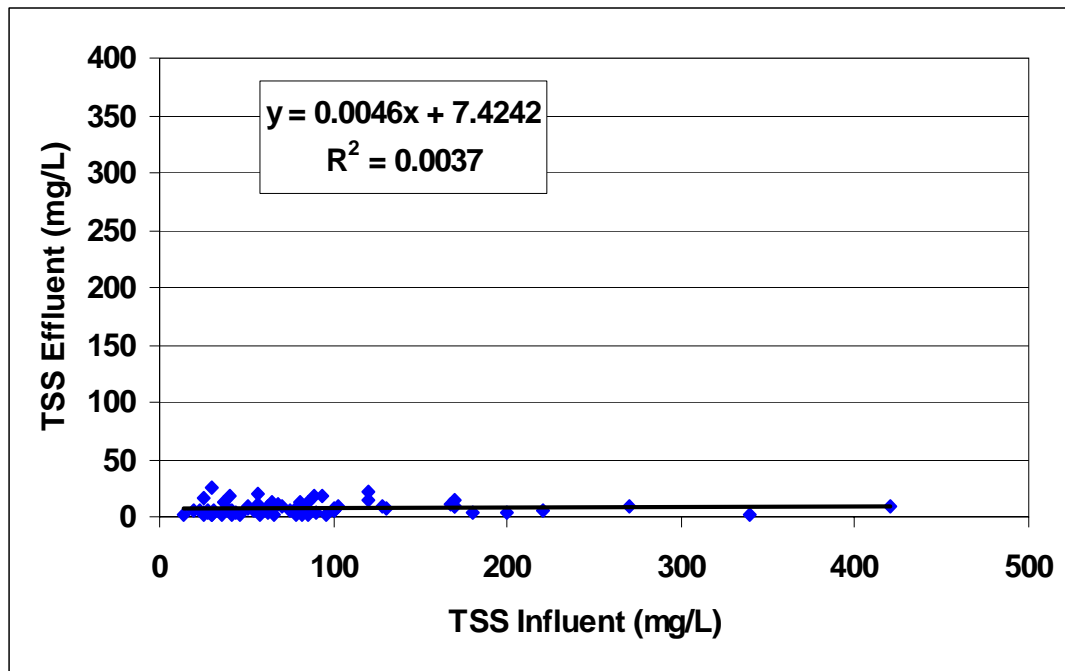

Figure 4  
Comparison of Influent and Effluent Concentrations for TSS

It is clearly evident that the effluent concentration is relative constant and independent of influent concentration. Consequently, the performance is more accurately characterized by the effluent concentration, which is about 7.5 mg/L. Constant effluent concentrations also are observed for all other particle related constituents such as particulate metals (total - dissolved) and particulate phosphorus.

The small uncertainty in the estimate of the mean effluent concentration highlights the very consistent effluent quality for TSS produced by sand filters. In addition, it demonstrates that a calculated percent reduction for TSS and other constituents with similar behavior for Austin sand filters is a secondary characteristic of the device and depends primarily on the specific influent concentrations observed. The distinction between a constant effluent quality and a percent reduction is extremely important to recognize if the results are to be used to estimate effluent quality from sand filters installed at other sites with different influent concentrations or for estimating compliance with water quality standards for storms with high concentrations of particulate constituents.

If the conventionally derived removal efficiency (90%) were used to estimate the TSS concentrations in the treated runoff from storms with high influent concentrations, the estimated effluent concentration would be too high. For instance, the storm with the highest observed influent concentration (420 mg/L) would be expected to have a concentration in the treated runoff of 42 mg/L, rather than the 10 mg/L that was measured. In fact, the TSS effluent concentrations for all events with influent concentrations greater than 200 mg/L were 10 mg/L or less.

The stable effluent concentration of a sand filter under very different influent TSS concentrations implies something about the properties of the influent particle size distribution. If one assumes that

only the smallest size fraction can pass through the filter, then the similarity in effluent concentrations suggests that there is little difference in the total mass of the smallest sized particles even when the total TSS concentration varies greatly. Further, the difference in TSS concentration must then be caused by changes in the relative amount of the larger size fractions. Further research is necessary to determine the range of particle size that is effectively removed in the filter and the portion of the size fraction of suspended solids that it represents in urban stormwater.

Sand filters are effective stormwater management practices for pollutant removal. Conventional removal rates for all sand filters and organic filters are presented in Table 1. With the exception of nitrates, which are always exported from filtering systems because of the conversion of ammonia and organic nitrogen to nitrate, they perform relatively well at removing pollutants.

	<b>Sand Filter (Glick et al, 1998)</b>	<b>Compost Filter System</b>		<b>Multi-Chamber Treatment Train</b>		
		<b>Stewart, 1992</b>	<b>Leif, 1999</b>	<b>Pitt et al., 1997</b>	<b>Pitt, 1996</b>	<b>Greb et al., 1998</b>
TSS	89	95	85	85	83	98
TP	59	41	4	80	-	84
TN	17	-	-	-	-	-
Nitrate	-76	-34	-95	-	14	-
Metals	72-86	61-88	44-75	65-90	91-100	83-89
Bacteria	65	-	-	-	-	-

From the few studies available, it is difficult to determine if organic filters necessarily have higher removal efficiencies than sand filters. The MCTT may have high pollutant removal for some constituents, although an evaluation of these devices by the California Department of Transportation indicated no significant difference for most conventional pollutants.

In addition to the relatively high pollutant removal in media filters, these devices, when sized to capture the channel forming storm volume, are highly effective at attenuating peak flow rates and reducing channel erosion.

**Siting Criteria**

In general, sand filters are preferred over infiltration practices, such as infiltration trenches, when contamination of groundwater with conventional pollutants is of concern. This usually occurs in areas where underlying soils alone cannot treat runoff adequately - or ground water tables are high. In most cases, sand filters can be constructed with impermeable basin or chamber bottoms, which help to collect, treat, and release runoff to a storm drainage system or directly to surface water with no contact between contaminated runoff and groundwater. In regions where evaporation exceeds rainfall and a wet pond would be unlikely to maintain the required permanent pool, a sand filtration system can be used.

The selection of a sand filter design depends largely on the drainage area's characteristics. For example, the Washington, D.C. and Delaware sand filter systems are well suited for highly impervious areas where land available for structural controls is limited, since both are installed underground. They have been used to treat runoff from parking lots, driveways, loading docks, service stations, garages, airport runways/taxiways, and storage yards. The Austin sand filtration system is more suited for large drainage areas that have both impervious and pervious surfaces. This system is located at grade and is used to treat runoff from any urban land use.

It is challenging to use most sand filters in very flat terrain because they require a significant amount of hydraulic head (about 4 feet), to allow flow through the system. One exception is the perimeter sand filter, which can be applied with as little as 2 feet of head.

Sand filters are best applied on relatively small sites (up to 25 acres for surface sand filters and closer to 2 acres for perimeter or underground filters). Filters have been used on larger drainage areas, of up to 100 acres, but these systems can clog when they treat larger drainage areas unless adequate measures are provided to prevent clogging, such as a larger sedimentation chamber or more intensive regular maintenance.

When sand filters are designed as a stand-alone practice, they can be used on almost any soil because they can be designed so that stormwater never infiltrates into the soil or interacts with the ground water. Alternatively, sand filters can be designed as pretreatment for an infiltration practice, where soils do play a role.

### Additional Design Guidelines

Pretreatment is a critical component of any stormwater management practice. In sand filters, pretreatment is achieved in the sedimentation chamber that precedes the filter bed. In this chamber, the coarsest particles settle out and thus do not reach the filter bed. Pretreatment reduces the maintenance burden of sand filters by reducing the potential for these sediments to clog the filter. When pretreatment is not provided designers should increase the size of the filter area to reduce the clogging potential. In sand filters, designers should select a medium sand as the filtering medium. A fine aggregate (ASTM C-33) that is intended for use in concrete is commonly specified.

Many guidelines recommend sizing the filter bed using Darcy's Law, which relates the velocity of fluids to the hydraulic head and the coefficient of permeability of a medium. The resulting equation, as derived by the city of Austin, Texas, (1996), is

$$A_f = WQV d / [k t (h+d)]$$

Where:

$A_f$  = area of the filter bed (ft<sup>2</sup>);

$d$  = depth of the filter bed (ft; usually about 1.5 feet, depending on the design);

$k$  = coefficient of permeability of the filtering medium (ft/day);

$t$  = time for the water quality volume to filter through the system (days; usually assumed to be 1.67 days); and

$h$  = average water height above the sand bed (ft; assumed to be one-half of the maximum head).

Typical values for  $k$ , as assembled by CWP (1996), are shown in Table 2.

<b>Filter Medium</b>	<b>Coefficient of Permeability (ft/day)</b>
Sand	3.5
Peat/Sand	2.75
Compost	8.7

The permeability of sand shown in Table 2 is extremely conservative, but is widely used since it is incorporated in the design guidelines of the City of Austin. When the sand is initially installed, the permeability is so high (over 100 ft/d) that generally only a portion of the filter area is required to infiltrate the entire volume, especially in a “full sedimentation” Austin design where the capture volume is released to the filter basin over 24 hours.

The preceding methodology results in a filter bed area that is oversized when new and the entire water quality volume is filtered in less than a day with no significant height of water on top of the sand bed. Consequently, the following simple rule of thumb is adequate for sizing the filter area. If the filter is preceded by a sedimentation basin that releases the water quality volume (WQV) to the filter over 24 hours, then

$$A_f = WQV/18$$

If no pretreatment is provided then the filter area is calculated more conservatively as:

$$A_f = WQV/10$$

Typically, filtering practices are designed as “off-line” systems, meaning that during larger storms all runoff greater than the water quality volume is bypassed untreated using a flow splitter, which is a structure that directs larger flows to the storm drain system or to a stabilized channel. One exception is the perimeter filter; in this design, all flows enter the system, but larger flows overflow to an outlet chamber and are not treated by the practice.

The Austin design variations are preferred where there is sufficient space, because they lack a permanent pool, which eliminates vector concerns. Design details of this variation are summarized below.

**Summary of Design Recommendations**

- (1) Capture Volume - The facility should be sized to capture the required water quality volume, preferably in a separate pretreatment sedimentation basin.

- (2) Basin Geometry – The water depth in the sedimentation basin when full should be at least 2 feet and no greater than 10 feet. A fixed vertical sediment depth marker should be installed in the sedimentation basin to indicate when 20% of the basin volume has been lost because of sediment accumulation. When a pretreatment sedimentation basin is provided the minimum average surface area for the sand filter ( $A_f$ ) is calculated from the following equation:

$$A_f = WQV/18$$

If no pretreatment is provided then the filter area is calculated as:

$$A_f = WQV/10$$

- (3) Sand and Gravel Configuration - The sand filter is constructed with 18 inches of sand overlying 6 inches of gravel. The sand and gravel media are separated by permeable geotextile fabric and the gravel layer is situated on geotextile fabric. Four-inch perforated PVC pipe is used to drain captured flows from the gravel layer. A minimum of 2 inches of gravel must cover the top surface of the PVC pipe. Figure 5 presents a schematic representation of a standard sand bed profile.
- (4) Sand Properties – The sand grain size distribution should be comparable to that of “washed concrete sand,” as specified for fine aggregate in ASTM C-33.
- (5) Underdrain Pipe Configuration – In an Austin filter, the underdrain piping should consist of a main collector pipe and two or more lateral branch pipes, each with a minimum diameter of 4 inches. The pipes should have a minimum slope of 1% (1/8 inch per foot) and the laterals should be spaced at intervals of no more than 10 feet. There should be no fewer than two lateral branch pipes. Each individual underdrain pipe should have a cleanout access location. All piping is to be Schedule 40 PVC. The maximum spacing between rows of perforations should not exceed 6 inches.
- (6) Flow Splitter - The inflow structure to the sedimentation chamber should incorporate a flow-splitting device capable of isolating the capture volume and bypassing the 25-year peak flow around the facility with the sedimentation/filtration pond full.

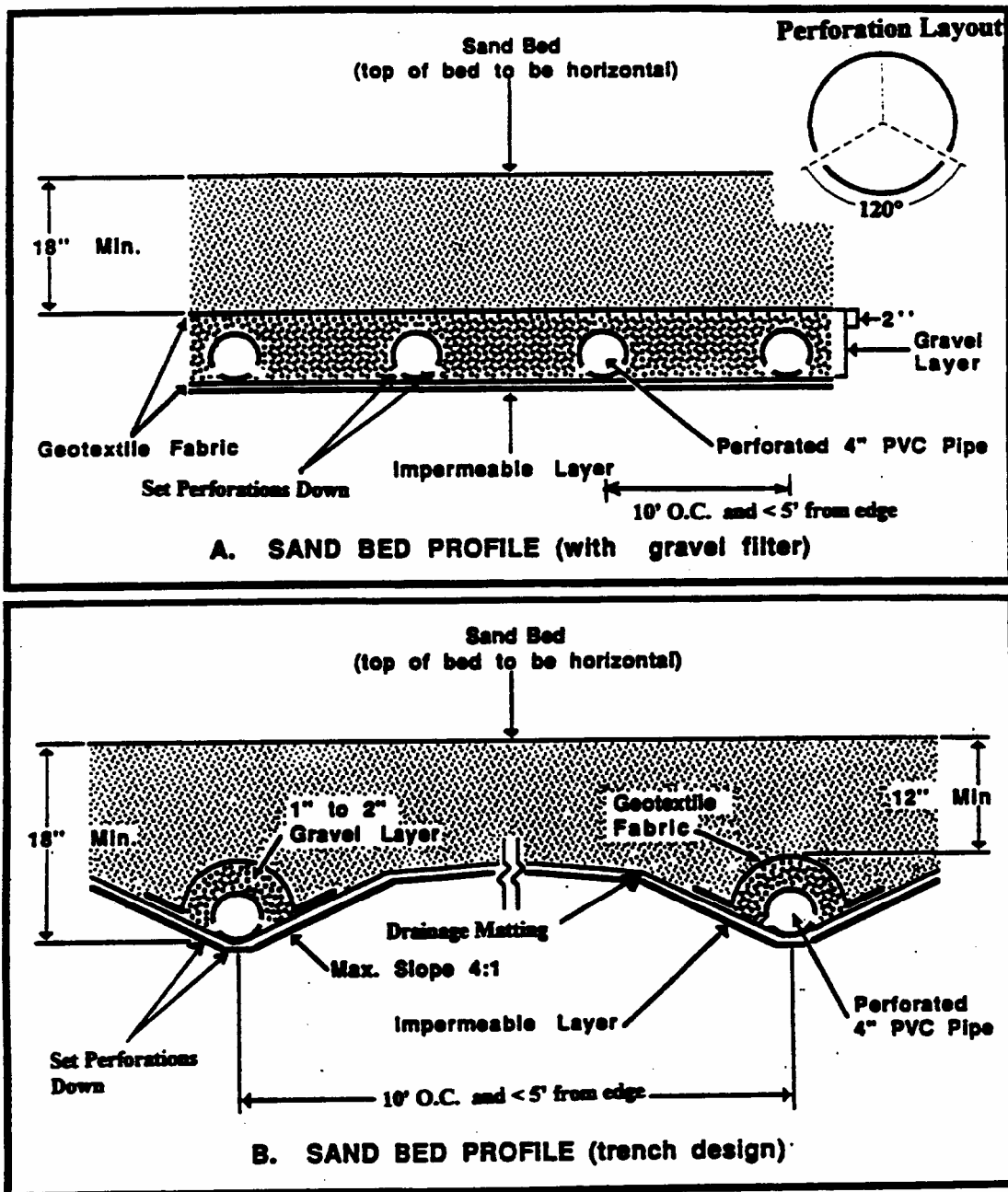

Figure 5  
Schematic of Sand Bed Profile

- (7) Basin Inlet – Energy dissipation is required at the sedimentation basin inlet so that flows entering the basin should be distributed uniformly and at low velocity in order to prevent resuspension and encourage quiescent conditions necessary for deposition of solids.
- (8) Sedimentation Pond Outlet Structure - The outflow structure from the sedimentation chamber should be (1) an earthen berm; (2) a concrete wall; or (3) a rock gabion. Gabion outflow structures should extend across the full width of the facility such that no short-circuiting of flows can occur. The gabion rock should be 4 inches in diameter. The

receiving end of the sand filter should be protected (splash pad, riprap, etc.) such that erosion of the sand media does not occur. When a riser pipe is used to connect the sedimentation and filtration basins (example in Figure 6), a valve should be included to isolate the sedimentation basin in case of a hazardous material spill in the watershed. The control for the valve must be accessible at all times, including when the basin is full. The riser pipe should have a minimum diameter of 6 inches with four 1-inch perforations per row. The vertical spacing between rows should be 4 inches (on centers).

- (9) Sand Filter Discharge – If a gabion structure is used to separate the sedimentation and filtration basins, a valve must be installed so that discharge from the BMP can be stopped in case runoff from a spill of hazardous material enters the sand filter. The control for the valve must be accessible at all times, including when the basin is full.

## Maintenance

Even though sand filters are generally thought of as one of the higher maintenance BMPs, in a recent California study an average of only about 49 hours a year were required for field activities. This was less maintenance than was required by extended detention basins serving comparable sized catchments. Most maintenance consists of routine removal of trash and debris, especially in Austin sand filters where the outlet riser from the sedimentation basin can become clogged.

Most data (i.e. Clark, 2001) indicate that hydraulic failure from clogging of the sand media occurs before pollutant breakthrough. Typically, only the very top of the sand becomes clogged while the rest remains in relative pristine condition as shown in Figure 7. The rate of clogging has been related to the TSS loading on the filter bed (Urbonas, 1999); however, the data are quite variable. Empirical observation of sites treating urban and highway runoff indicates that clogging of the filter occurs after 2 – 10 years of service. Presumably, this is related to differences in the type and amount of sediment in the catchment areas of the various installations. Once clogging occurs the top 2 – 3 inches of filter media is removed, which restores much, but not all, of the lost permeability. This removal of the surface layer can occur several times before the entire filter bed must be replaced. The cost of the removal of the surface layer is not prohibitive, generally ranging between \$2,000 (EPA Fact Sheet) and \$4,000 (Caltrans, 2002) depending on the size of the filter.

Media filters can become a nuisance due to mosquito and midge breeding in certain designs or if not regularly maintained. "Wet" designs (e.g., MCTT and Delaware filter) are more conducive to vectors than others (e.g., Austin filters) because they maintain permanent sources of standing water where breeding is likely to occur. Caltrans successfully excluded mosquitoes and midges from accessing the permanent water in the sedimentation basin of MCTT installations through use of a tight-fitting aluminum cover to seal vectors out. However, typical wet designs may require routine inspections and treatments by local mosquito and vector control agencies to suppress mosquito production. Vector habitats may also be created in "dry" designs when media filters clog, and/or when features such as level spreaders that hold water over 72 hours are included in the installation. Dry designs such as Austin filters should dewater completely (recommended 72 hour residence time or less) to prevent creating mosquito and other vector habitats. Maintenance efforts to prevent vector breeding in dry designs will need to focus on basic housekeeping practices such as removal of debris accumulations and vegetation management (in filter media) to prevent clogs and/or pools of standing water.

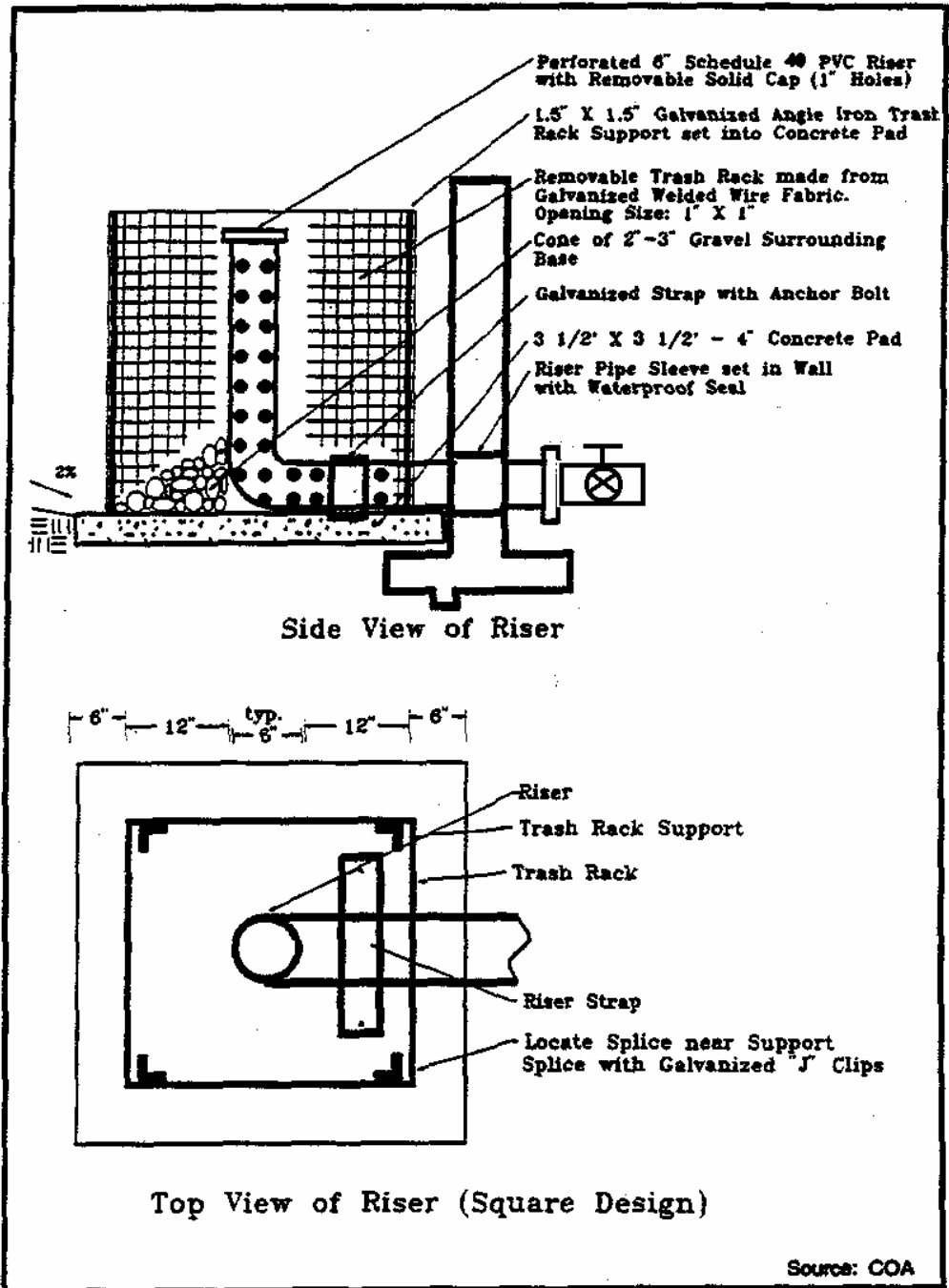

Figure 6  
Detail of Sedimentation Riser Pipe





Figure 7  
Formation of Clogging Crust on Filter Bed

Recommended maintenance activities and frequencies include:

- Inspections semi-annually for standing water, sediment, trash and debris, and to identify potential problems.
- Remove accumulated trash and debris in the sedimentation basin, from the riser pipe, and the filter bed during routine inspections.
- Inspect the facility once during the wet season after a large rain event to determine whether the facility is draining completely within 72 hr.
- Remove top 50 mm (2 in.) of sand and dispose of sediment if facility drain time exceeds 72 hr. Restore media depth to 450 mm (18 in.) when overall media depth drops to 300 mm (12 in.).
- Remove accumulated sediment in the sedimentation basin every 10 yr or when the sediment occupies 10 percent of the basin volume, whichever is less.

## Cost

### **Construction Cost**

There are few consistent published data on the cost of sand filters, largely because, with the exception of Austin, Texas, Alexandria, Virginia, and Washington, D.C., they have not been widely used. Furthermore, filters have such varied designs that it is difficult to assign a cost to filters in general. A study by Brown and Schueler (1997) was unable to find a statistically valid relationship between the volume of water treated in a filter and the cost of the practice. The EPA filter fact sheet indicates a cost for an Austin sand filter at \$18,500 (1997 dollars) for a 0.4 hectare- (1 acre-)

drainage area. However, the same design implemented at a 1.1 ha site by the California Department of Transportation, cost \$240,000. Consequently, there is a tremendous uncertainty about what the average construction cost might be.

It is important to note that, although underground and perimeter sand filters can be more expensive than surface sand filters, they consume no surface space, making them a relatively cost-effective practice in ultra-urban areas where land is at a premium.

Given the number of facilities installed in the areas that promote their use it should be possible to develop fairly accurate construction cost numbers through a more comprehensive survey of municipalities and developers that have implemented these filters.

**Maintenance Cost**

Annual costs for maintaining sand filter systems average about 5 percent of the initial construction cost (Schueler, 1992). Media is replaced as needed, with the frequency correlated with the solids loading on the filter bed. Currently the sand is being replaced in the D.C. filter systems about every 2 years, while an Austin design might last 3-10 years depending on the watershed characteristics. The cost to replace the gravel layer, filter fabric and top portion of the sand for D.C. sand filters is approximately \$1,700 (1997 dollars).

Caltrans estimated future maintenance costs for the Austin design, assuming a device sized to treat runoff from approximately 4 acres. These estimates are presented in Table 3 and assume a fully burdened hourly rate of \$44 for labor. This estimate is somewhat uncertain, since complete replacement of the filter bed was not required during the period that maintenance costs were recorded.

<b>Activity</b>	<b>Labor Hours</b>	<b>Equipment and Materials (\$)</b>	<b>Cost</b>
Inspections	4	0	176
Maintenance	36	125	1,706
Vector Control	0	0	0
Administration	3	0	132
Direct Costs	-	888	888
<b>Total</b>	<b>43</b>	<b>\$1,013</b>	<b>\$2,902</b>

**References and Sources of Additional Information**

Barton Springs/Edwards Aquifer Conservation District. 1996. *Final Report: Enhanced Roadway Runoff Best Management Practices*. City of Austin, Drainage Utility, LCRA, TDOT. Austin, TX. 200 pp.

Bell, W., L. Stokes, L.J. Gavan, and T.N. Nguyen. 1995. *Assessment of the Pollutant Removal Efficiencies of Delaware Sand Filter BMPs*. Final Report. Department of Transportation and

Environmental Services. Alexandria, VA. 140 pp. Also in Performance of Delaware Sand Filter Assessed. Watershed Protection Techniques. Center for Watershed Protection. Fall 1995. Vol. 2(1): 291–293.

Brown, W., and T. Schueler. 1997. *The Economics of Stormwater BMPs in the Mid-Atlantic Region*. Prepared for the Chesapeake Research Consortium, Edgewater, MD, by the Center for Watershed Protection, Ellicott City, MD.

Caltrans, 2002, *Proposed Final Report: BMP Retrofit Pilot Program*, California Dept. of Transportation Report CTSW-RT-01-050, Sacramento, CA.

Center for Watershed Protection (CWP). 1996. *Design of Stormwater Filtering Systems*. Prepared for the Chesapeake Research Consortium, Solomons, MD, and U.S. EPA Region 5, Chicago, IL, by the Center for Watershed Protection, Ellicott City, MD.

Center for Watershed Protection (CWP). 1997. Multi-Chamber Treatment Train developed for stormwater hot spots. *Watershed Protection Techniques* 2(3):445–449.

City of Austin, TX. 1990. *Removal Efficiencies of Stormwater Control Structures*. Final Report. Environmental Resource Management Division. 36 p. Also in: Developments in Sand Filter Technology to Improve Stormwater Runoff Quality. Watershed Protection Techniques. Center for Watershed Protection. Summer 1994. Vol. 1(2): 47–54.

City of Austin, TX. 1996. *Design of Water Quality Controls*. City of Austin, TX.

Clark, S.E., 2000, Urban Stormwater Filtration: Optimization of Design Parameters and a Pilot-Scale Evaluation, Ph.D. Dissertation, University of Alabama at Birmingham.

CSF Treatment Systems, Inc. (CSF). 1996. *Stormwater management promotional brochure*. CSF Treatment Systems, Inc., Portland, OR.

Curran, T. 1996. Peat Sand Efficiency Calculations for McGregor Park. Unpublished data. Lower Colorado River Authority. Austin, TX.

Galli, F. 1990. Peat-Sand Filters: *A Proposed Stormwater Management Practice for Urban Areas*. Metropolitan Washington Council of Governments, Washington, DC.

Glick, Roger, Chang, George C., and Barrett, Michael E., 1998, Monitoring and evaluation of stormwater quality control basins, in *Watershed Management: Moving from Theory to Implementation*, Denver, CO, May 3-6, 1998, pp. 369 – 376.

Greb, S., S. Corsi, and R. Waschbush. 1998. Evaluation of Stormceptor© and Multi-Chamber Treatment Train as Urban Retrofit Strategies. Presented at Retrofit Opportunities for Water Resource Protection in Urban Environments, A National Conference. The Westin Hotel, Chicago, IL, February 10–12, 1998.

Harper, H., and J. Herr. 1993. *Treatment Efficiency of Detention With Filtration Systems*. Environmental Research and Design, Inc. Final Report Submitted to Florida Department of Environmental Regulation. Orlando, FL. 164 pp.

- Horner, R.R. and Horner, C.R., 1999, Performance of a Perimeter (“Delaware”) Sand Filter in Treating Stormwater Runoff from a Barge Loading Terminal. *Proc. of the Comprehensive Stormwater and Aquatic Ecosystem Management Conf.*, Auckland, N.Z., Feb. 1999, pp. 183-192.
- Horner, R.R., and C.R. Horner. 1995. *Design, Construction and Evaluation of a Sand Filter Stormwater Treatment System*. Part II. Performance Monitoring. Report to Alaska Marine Lines, Seattle, WA. 38 p. Also in Performance of Delaware Sand Filter Assessed. Watershed Protection Techniques. Center for Watershed Protection. Fall 1995. Vol. 2(1): 291–293.
- Kebbin, Michael V., Barrett, Michael E., Malina, Joseph F., Jr., Charbeneau, Randall J, 1998, *The Effectiveness of Permanent Highway Runoff Controls: Sedimentation/Filtration Systems*, Research Report 2954-1, Center for Transportation Research, University of Texas at Austin.
- King County, Washington, Department of Natural Resources. 2000. *King County Surface Water Design Manual*. <http://splash.metrokc.gov/wlr/dss/manual.htm>. Last updated March 6, 2000. Accessed January 5, 2001.
- Leif, T. 1999. *Compost Stormwater Filter Evaluation*. Snohomish County, Washington, Department of Public Works, Everett, WA.
- Maryland Department of the Environment (MDE). 2000. *Maryland Stormwater Design Manual*. <http://www.mde.state.md.us/environment/wma/stormwatermanual>. Accessed May 22, 2001.
- Metzger, M. E., D. F. Messer, C. L. Beitia, C. M. Myers, and V. L. Kramer. 2002. The fvBMPs. *Stormwater* 3(2): 24-39.
- Pitt, R. 1996. The Control of Toxicants at Critical Source Areas. Presented at the ASCE/Engineering Foundation Conference, Snowbird, UT, August 1996.
- Pitt, R., M. Lilburn, and S. Burian. 1997. *Storm Drainage Design for the Future: Summary of Current U.S. EPA Research*. American Society of Civil Engineers Technical Conference, Gulf Shores, AL, July 1997.
- Robertson, B., R. Pitt, A. Ayyoubi, and R. Field. 1995. A Multi-Chambered Stormwater Treatment Train. In *Proceedings of the Engineering Foundation Conference: Stormwater NPDES-Related Monitoring Needs, Mt. Crested Butte, Colorado, August 7–12, 1994*, American Society of Civil Engineers, New York, New York.
- Schueler, T. 1994. Developments in sand filter technology to improve stormwater runoff quality. *Watershed Protection Techniques* 1(2):47–54.
- Schueler, T. 1997. Comparative Pollutant Removal Capability of Urban BMPs: A Reanalysis. *Watershed Protection Techniques* 2(4):515–520.
- Stewart, W. 1992. *Compost Stormwater Treatment System*. W&H Pacific Consultants. Draft Report. Portland, OR. Also in Innovative Leaf Compost System Used to Filter Runoff at Small Sites in the Northwest. *Watershed Protection Techniques*. Center for Watershed Protection. February 1994. Vol. 1(1): 13–14.

Urbonas, B.R, 1999, Design of a sand filter for stormwater quality enhancement, Water Environment Research, V. 71, No. 1, pp. 102-113.

U.S. EPA, 1999, Stormwater Technology Fact Sheet: Sand Filters, Report EPA 832-F-99-007 <http://www.epa.gov/owm/mtb/sandfiltr.pdf>, Office of Water, Washington, DC

Washington State Department of Ecology (DOE). 1992. *Stormwater Management Manual for the Puget Sound Basin*, Washington State Department of Ecology, Olympia, WA.

Watershed Management Institute (WMI). 1997. *Operation, Maintenance, and Management of Stormwater Management Systems*. Prepared for U.S. EPA Office of Water, Washington, DC, by Watershed Management Institute.

Welborn, C., and J. Veenhuis. 1987. *Effects of Runoff Controls on the Quantity and Quality of Urban Runoff in Two Locations in Austin, TX*. USGS Water Resources Investigations Report. 87-4004. 88 pp.

Young, G.K., et al., 1996, *Evaluation and Management of Highway Runoff Water Quality*, Publication No. FHWA-PD-96-032, U.S. Department of Transportation, Federal Highway Administration, Office of Environment and Planning.

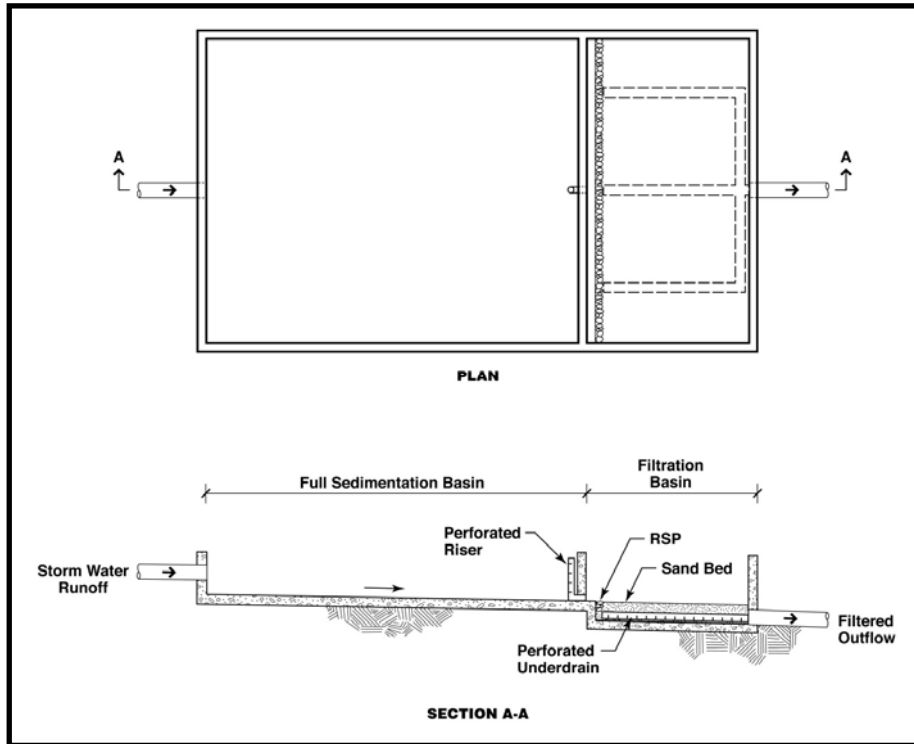

Schematic of the "Full Sedimentation" Austin Sand Filter

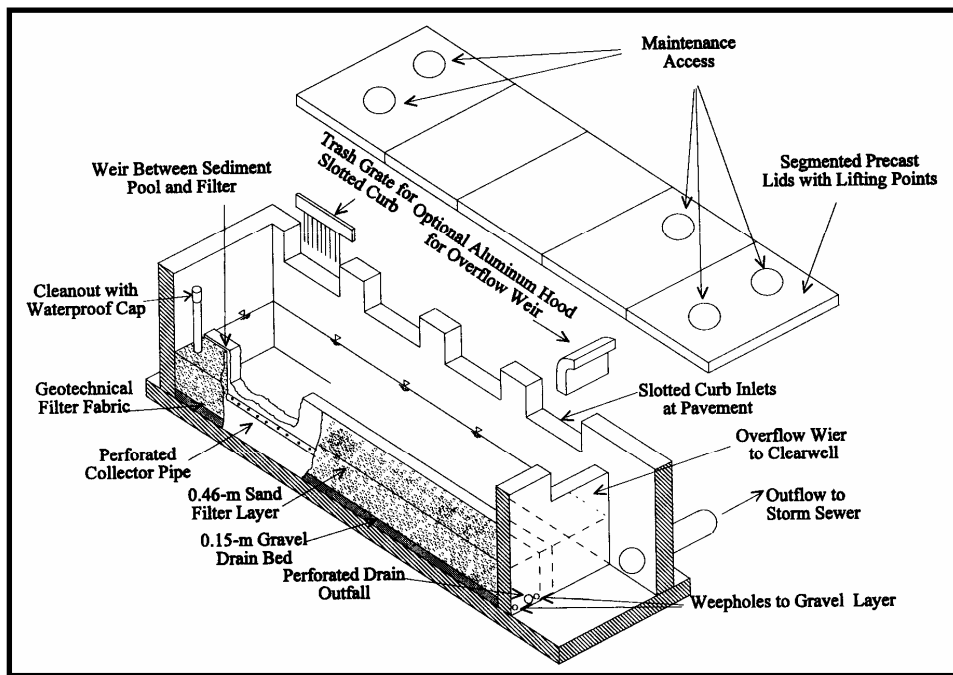

Schematic of a Delaware Sand Filter (Young et al., 1996)

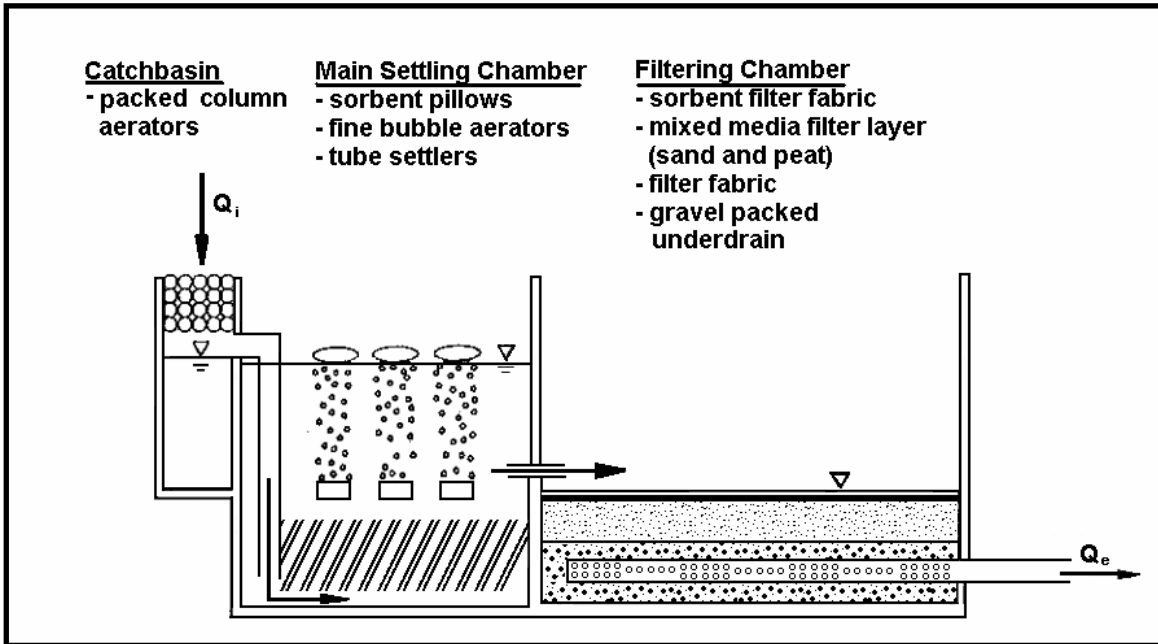

Schematic of a MCTT (Robertson et al., 1995)





## Description

Water quality inlets (WQIs), also commonly called trapping catch basins, oil/grit separators or oil/water separators, consist of one or more chambers that promote sedimentation of coarse materials and separation of free oil (as opposed to emulsified or dissolved oil) from stormwater. Some WQIs also contain screens to help retain larger or floating debris, and many of the newer designs also include a coalescing unit that helps promote oil/water separation. A typical WQI, as shown in the schematic, consists of a sedimentation chamber, an oil separation chamber, and a discharge chamber.

These devices are appropriate for capturing hydrocarbon spills, but provide very marginal sediment removal and are not very effective for treatment of stormwater runoff. WQIs typically capture only the first portion of runoff for treatment and are generally used for pretreatment before discharging to other best management practices (BMPs).

## California Experience

Caltrans investigated the use of coalescing plate oil/water separators at maintenance stations in Southern California. Twenty-two maintenance stations were originally considered for implementation of this technology; however, only one site appeared to have concentrations that were sufficiently high to warrant installation of an oil-water separator. Concentrations of free oil in stormwater runoff observed during the course of the study even from this site were too low for effective operation of this technology, and no free oil was ever captured by the device.

## Advantages

- Can provide spill control.

## Limitations

- WQIs generally provide limited hydraulic and residuals storage. Due to the limited storage, WQIs do not provide substantial stormwater improvement.
- Standing water in the devices can provide a breeding ground for mosquitoes.
- Certain designs maintain permanent sources of standing water where mosquito and other vector breeding may occur.

## Design and Sizing Guidelines

- Water quality inlets are most effective for spill control and should be sized accordingly.

## Design Considerations

- Area Required

## Targeted Constituents

<input checked="" type="checkbox"/>	Sediment	●
<input checked="" type="checkbox"/>	Nutrients	●
<input checked="" type="checkbox"/>	Trash	▲
<input checked="" type="checkbox"/>	Metals	●
<input checked="" type="checkbox"/>	Bacteria	●
<input checked="" type="checkbox"/>	Oil and Grease	▲
<input checked="" type="checkbox"/>	Organics	●

### Legend (*Removal Effectiveness*)

- Low
- High
- ▲ Medium



- Designs that utilize covered sedimentation and filtration basins should be accessible to vector control personnel via access doors to facilitate vector surveillance and controlling the basins if needed.

### Performance

WQIs are primarily utilized to remove sediment from stormwater runoff. Grit and sediment are partially removed by gravity settling within the first two chambers. A WQI with a detention time of 1 hour may expect to have 20 to 40 percent removal of sediments. Hydrocarbons associated with the accumulated sediments are also often removed from the runoff through this process. The WQI achieves slight, if any, removal of nutrients, metals and organic pollutants other than free petroleum products (Schueler, 1992).

A 1993 MWCOG study found that an average of less than 5 centimeters (2 inches) of sediments (mostly coarse-grained grit and organic matter) were trapped in the WQIs. Hydrocarbon and total organic carbon (TOC) concentrations of the sediments averaged 8,150 and 53,900 milligrams per kilogram, respectively. The mean hydrocarbon concentration in the WQI water column was 10 milligrams per liter. The study also indicated that sediment accumulation did not increase over time, suggesting that the sediments become re-suspended during storm events. The authors concluded that although the WQI effectively separates oil and grease from water, re-suspension of the settled matter appears to limit removal efficiencies. Actual removal only occurs when the residuals are removed from the WQI (Schueler 1992).

A 1990 report by API found that the efficiency of oil and water separation in a WQI is inversely proportional to the ratio of the discharge rate to the unit's surface area. Due to the small capacity of the WQI, the discharge rate is typically very high and the detention time is very short. For example, the MWCOG study found that the average detention time in a WQI is less than 0.5 hour. This can result in minimal pollutant settling (API, 1990). However, the addition of coalescing units in many current WQI units may increase oil/water separation efficiency. Most coalescing units are designed to achieve a specific outlet concentration of oil and grease (for example, 10-15 mg/L oil and grease).

Pollutant removal in stormwater inlets can be somewhat improved using inserts, which are promoted for removal of oil and grease, trash, debris, and sediment. Some inserts are designed to drop directly into existing catch basins, while others may require extensive retrofit construction.

### Siting Criteria

Oil/water separation units are often utilized in specific industrial areas, such as airport aprons, equipment washdown areas, or vehicle storage areas. In these instances, runoff from the area of concern will usually be diverted directly into the unit, while all other runoff is sent to the storm drain downstream from the oil/water separator. Oil/water separation tanks are often fitted with diffusion baffles at the inlets to prevent turbulent flow from entering the unit and resuspending settled pollutants.

### Additional Design Guidelines

Prior to WQI design, the site should be evaluated to determine if another BMP would be more cost-effective in removing the pollutants of concern. WQIs should be used when no other BMP is feasible. The WQI should be constructed near a storm drain network so that flow can be easily diverted to the WQI for treatment (NVPDC, 1992). Any construction activities within the

drainage area should be completed before installation of the WQI, and the drainage area should be revegetated so that the sediment loading to the WQI is minimized.

WQIs are most effective for small drainage areas. Drainage areas of 0.4 hectares (1 acre) or less are often recommended. WQIs are typically used in an off-line configuration (i.e., portions of runoff are diverted to the WQI), but they can be used as on-line units (i.e., receive all runoff). Generally, off-line units are designed to handle the first 1.3 centimeters (0.5 inches) of runoff from the drainage areas. Upstream isolation/diversion structures can be used to divert the water to the off-line structure (Schueler, 1992). On-line units receive higher flows that will likely cause increased turbulence and resuspension of settled material, thereby reducing WQI performance.

Oil/water separation tanks are often fitted with diffusion baffles at the inlets to prevent turbulent flow from entering the unit and resuspending settled pollutants. WQIs are available as pre-manufactured units or can be cast in place. Reinforced concrete should be used to construct below-grade WQIs. The WQIs should be water tight to prevent possible ground water contamination.

## Maintenance

Typical maintenance of WQIs includes trash removal if a screen or other debris capturing device is used, and removal of sediment using a vacuum truck. Operators need to be properly trained in WQI maintenance. Maintenance should include keeping a log of the amount of sediment collected and the date of removal. Some cities have incorporated the use of GIS systems to track sediment collection and to optimize future catch basin cleaning efforts.

One study (Pitt, 1985) concluded that WQIs can capture sediments up to approximately 60 percent of the sump volume. When sediment fills greater than 60 percent of their volume, catch basins reach steady state. Storm flows can then resuspend sediments trapped in the catch basin, and will bypass treatment. Frequent clean-out can retain the volume in the catch basin sump available for treatment of stormwater flows.

At a minimum, these inlets should be cleaned at least twice during the wet season. Two studies suggest that increasing the frequency of maintenance can improve the performance of catch basins, particularly in industrial or commercial areas. One study of 60 catch basins in Alameda County, California, found that increasing the maintenance frequency from once per year to twice per year could increase the total sediment removed by catch basins on an annual basis (Mineart and Singh, 1994). Annual sediment removed per inlet was 54 pounds for annual cleaning, 70 pounds for semi-annual and quarterly cleaning, and 160 pounds for monthly cleaning. For catch basins draining industrial uses, monthly cleaning increased total annual sediment collected to six times the amount collected by annual cleaning (180 pounds versus 30 pounds). These results suggest that, at least for industrial uses, more frequent cleaning of catch basins may improve efficiency.

BMPs designed with permanent water sumps, vaults, and/or catch basins (frequently installed below-ground) can become a nuisance due to mosquito and other vector breeding. Preventing mosquito access to standing water sources in BMPs (particularly below-ground) is the best prevention plan, but can prove challenging due to multiple entrances and the need to maintain the hydraulic integrity of the system. BMPs that maintain permanent standing water may require routine inspections and treatments by local mosquito and vector control agencies to

suppress mosquito production. Standing water in oil/water separators may contain sufficient floating hydrocarbons to prevent mosquito breeding, but this is not a reliable control alternative to vector exclusion or chemical treatment.

### Cost

A typical pre-cast catch basin costs between \$2,000 and \$3,000; however, oil/water separators can be much more expensive. The true pollutant removal cost associated with catch basins, however, is the long-term maintenance cost. A vactor truck, the most common method of catch basin cleaning, costs between \$125,000 and \$150,000. This initial cost may be high for smaller Phase II communities. However, it may be possible to share a vactor truck with another community. Typical vactor trucks can store between 10 and 15 cubic yards of material, which is enough storage for three to five catch basins. Assuming semi-annual cleaning, and that the vactor truck could be filled and material disposed of twice in one day, one truck would be sufficient to clean between 750 and 1,000 catch basins. Another maintenance cost is the staff time needed to operate the truck. Depending on the regulations within a community, disposal costs of the sediment captured in catch basins may be significant.

### References and Sources of Additional Information

American Petroleum Institute (API), 1990. *Monographs on Refinery Environmental Control - Management of Water Discharges (Design and Operation of Oil-Water Separators)*. Publication 421, First Edition.

Aronson, G., D. Watson, and W. Pisaro. *Evaluation of Catch Basin Performance for Urban Stormwater Pollution Control*. U.S. Environmental Protection Agency, Washington, DC.

Berg, V.H., 1991. *Water Quality Inlets (Oil/Grit Separators)*. Maryland Department of the Environment, Sediment and Stormwater Administration.

Lager, J., W. Smith, R. Finn, and E. Finnemore. 1977. *Urban Stormwater Management and Technology: Update and Users' Guide*. Prepared for U.S. Environmental Protection Agency. EPA-600/8-77-014. 313 pp.

Metropolitan Washington Council of Governments (MWCOC), 1993. *The Quality of Trapped Sediments and Pool Water Within Oil Grit Separators in Suburban Maryland*. Interim Report.

Metzger, M. E., D. F. Messer, C. L. Beitia, C. M. Myers, and V. L. Kramer. 2002. The Dark Side Of Stormwater Runoff Management: Disease Vectors Associated With Structural Bmps. *Stormwater* 3(2): 24-39.

Metzger, M. E., and S. Kluh. 2003. Surface Hydrocarbons Vs. Mosquito Breeding. *Stormwater* 4(1): 10.

Mineart, P., and S. Singh. 1994. *Storm Inlet Pilot Study*. Alameda County Urban Runoff Clean Water Program, Oakland, CA.

Northern Virginia Planning District Commission (NVPDC) and Engineers and Surveyors Institute, 1992. *Northern Virginia BMP Handbook*.

Pitt, R., and P. Bissonnette. 1984. *Bellevue Urban Runoff Program Summary Report*. U.S. Environmental Protection Agency, Water Planning Division, Washington, DC.

Pitt, R., M. Lilburn, S. Nix, S.R. Durrans, S. Burian, J. Voorhees, and J. Martinson. 2000. *Guidance Manual for Integrated Wet Weather Flow (WWF) Collection and Treatment Systems for Newly Urbanized Areas (New WWF Systems)*. U.S. Environmental Protection Agency, Office of Research and Development, Cincinnati, OH.

Schueler, T.R., 1992. *A Current Assessment of Urban Best Management Practices*. Metropolitan Washington Council of Governments.

U.S. EPA, 1999, Stormwater Technology Fact Sheet: Water Quality Inlets, EPA 832-F-99-029, Office of Water, Washington DC.

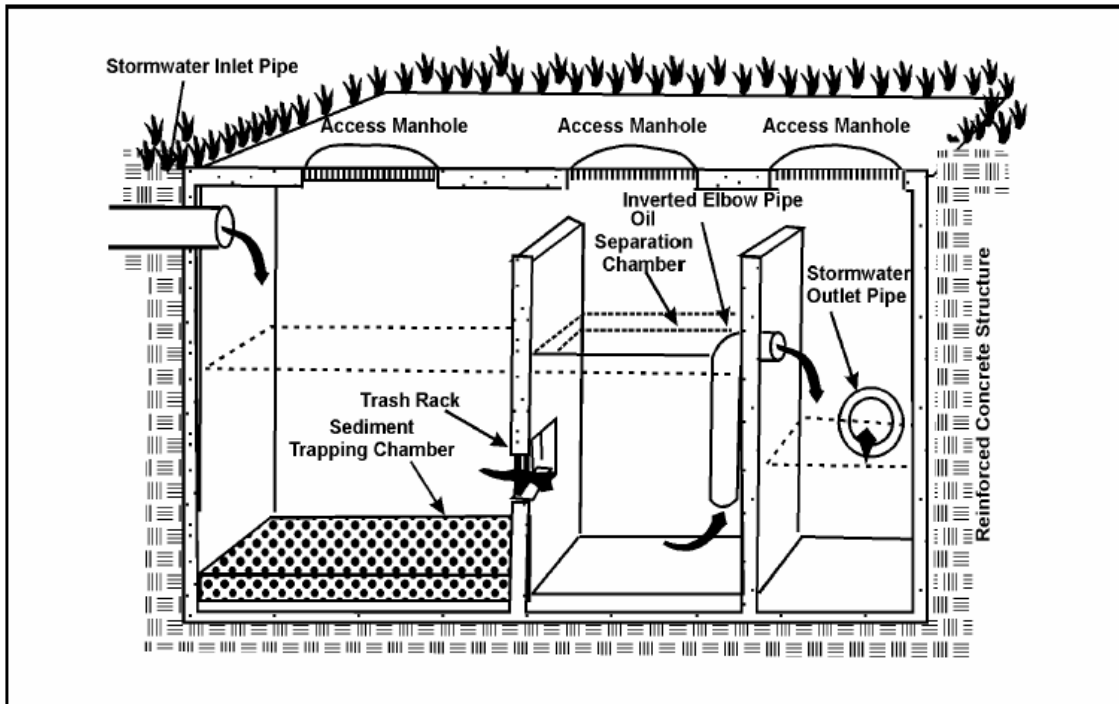

## Description

A multiple treatment system uses two or more BMPs in series. Some examples of multiple systems include: settling basin combined with a sand filter; settling basin or biofilter combined with an infiltration basin or trench; extended detention zone on a wet pond.

## California Experience

The research wetlands at Fremont, California are a combination of wet ponds, wetlands, and vegetated controls.

## Advantages

- BMPs that are less sensitive to high pollutant loadings, especially solids, can be used to pretreat runoff for sand filters and infiltration devices where the potential for clogging exists.
- BMPs which target different constituents can be combined to provide treatment for all constituents of concern.
- BMPs which use different removal processes (sedimentation, filtration, biological uptake) can be combined to improve the overall removal efficiency for a given constituent.
- BMPs in series can provide redundancy and reduce the likelihood of total system failure.

## Limitations

- Capital costs of multiple systems are higher than for single devices.
- Space requirements are greater than that required for a single technology.

## Design and Sizing Guidelines

Refer to individual treatment control BMP fact sheets.

## Performance

- Be aware that placing multiple BMPs in series does not necessarily result in combined cumulative increased performance. This is because the first BMP may already achieve part of the gain normally achieved by the second BMP. On the other hand, picking the right combination can often help optimize performance of the second BMP since the influent to the second BMP is of more consistent water quality, and thus more consistent performance, thereby allowing the BMP to achieve its highest performance.

## Design Considerations

- Area Required
- Slope
- Water Availability
- Hydraulic Head
- Environmental Side-effects

## Targeted Constituents

<input checked="" type="checkbox"/>	Sediment	■
<input checked="" type="checkbox"/>	Nutrients	●
<input checked="" type="checkbox"/>	Trash	■
<input checked="" type="checkbox"/>	Metals	■
<input checked="" type="checkbox"/>	Bacteria	▲
<input checked="" type="checkbox"/>	Oil and Grease	■
<input checked="" type="checkbox"/>	Organics	■

### Legend (*Removal Effectiveness*)

- Low
- High
- ▲ Medium



- When addressing multiple constituents through multiple BMPs, one BMP may optimize removal of a particular constituent, while another BMP optimizes removal of a different constituent or set of constituents. Therefore, selecting the right combination of BMPs can be very constructive in collectively removing multiple constituents.

## **Siting Criteria**

Refer to individual treatment control BMP fact sheets.

## **Additional Design Guidelines**

- When using two or more BMPs in series, it may be possible to reduce the size of BMPs.
- Existing pretreatment requirements may be able to be avoided when using some BMP combinations.

## **Maintenance**

Refer to individual treatment control BMP fact sheets.

## **Cost**

Refer to individual treatment control BMP fact sheets.

## **Resources and Sources of Additional Information**

Refer to individual treatment control BMP fact sheets.



## Description

A manufactured wetland is similar to public domain stormwater wetlands. In a manufactured wetland, gravel substrate and subsurface flow of the stormwater through the root systems force the vegetation to remove nutrients and dissolved pollutants from the stormwater.

Only one company currently manufactures a pre-engineered wetland: It consists of a standard module, about 9.5 feet in diameter and 4 feet in height. The module is constructed of recycled polyethylene. The number of units is varied to meet the design volume of the site.

## California Experience

There are currently only a few installations in California.

## Advantages

- Constructed wetlands remove dissolved pollutants unlike many of the other treatment technologies, whether manufactured or in the public domain.
- Gravel substrate and subsurface flow of the stormwater through the root systems forces the vegetation to remove nutrients and dissolved pollutants from the stormwater.
- Unlike standard constructed wetlands (TC-21), there is no standing water in the manufactured wetland between storms (after emptying with each storm). This minimizes but does not entirely eliminate the opportunity for mosquito breeding.
- Can be incorporated into the landscaping of the development.
- The gravel substrate likely provides a good environment for bacteria, facilitating the removal of nitrogen and the degradation of oil and greases, and other organic compounds.
- The gravel substrate can be augmented with media that is specifically effective at removing dissolved pollutants, increasing further the performance of the system.
- Vegetation is more easily harvested in comparison to a wet pond or standard constructed wetland (TC-21).
- Provides modest habitat for insects and other small invertebrates which in turn provide food for birds and other small animals.

## Design Considerations

- Drainage Area Size
- Potential Pretreatment Requirements

## Targeted Constituents

- Sediment
- Nutrients
- Trash
- Metals
- Bacteria
- Oil and Grease
- Organics

### *Removal Effectiveness*

See New Development and Redevelopment Handbook-Section 5.



**Limitations**

- Not likely suitable for drainage areas greater than an acre due to the number of units that is required for larger sites.
- May attract invasive wetland species
- May require irrigation during the dry season
- With an emptying time as much as 5 days, a breeding ground for mosquitoes may occur during and immediately following each storm
- If site development requirements of local government also includes detention for flow control, the drawdown characteristics of the system must be compatible with the detention system.
- Where many units are required, the pattern of circular plastic covers of the center wells may not be appealing.

**Design and Sizing Guidelines**

The unit consists of two concentric chambers, analogous to a doughnut. The inner chamber is open whereas the outer chamber is filled with gravel in which the wetland plants reside. The water enters a center well, moving in a circular motion around nearly the entire circumference of the well. Via floating surface skimmers the water then enters the outer chamber. The flow rate is controlled at the outlet with a valve. The substrate for the vegetation is small gravel. Gravel substrate encourages the wetland vegetation to use nutrients and metals in the stormwater. The concept of subsurface flow through gravel has its parentage with subsurface flow constructed wetlands used to treat wastewater.

The unit includes a burlap bag over the inlet to remove debris, and screens within the center well for the same purpose. However, the upstream drainage system is considered the primary remover of coarse solids and debris. If the drainage system lacks drain inlets with sumps where coarse sediments and floatables are removed, it is desirable to include a pretreatment unit for this purpose such as a manhole or wet vault of suitable size.

<b>Targeted Pollutant</b>	<b>Alternative Media</b>	<b>References</b>
Complex organics (e.g., pesticides)	Activated carbon	Metcalf and Eddy (2002), Minton (2002)
Petroleum hydrocarbons	Activated carbon, organoclay, granular polymer	Minton (2002)
Dissolved metals	Zeolite, activated carbon	Minton (2002), Groffman, et al. (1997), Netzer and Hughes (1984), Stormwater Management Inc. technical memos
Dissolved phosphorus	Blast furnace slag, iron-ore, iron wool, limestone, aluminum oxide, dolomite, iron-infused resin	James, et al. (1992), Minton (2002), Shapiro (1999), Ayoub, et al. (2001), Storm-water Management Inc memos

The design water quality volume is determined by local governments or sized so that 85% of the annual runoff volume is treated.

### ***Construction/Inspection Considerations***

Refer to manufacturer guidelines.

### **Performance**

There is little operating data for the manufactured wetland, although these data indicate very high removal efficiencies, similar to created stormwater wetlands. An advantage of wet ponds and standard constructed wetlands over most other treatment technologies is the removal of dissolved pollutants. However, this occurs only to the extent that the stormwater pollutants are able to diffuse into the soil where they are removed by the soil or the plants. Except for non-rooted plants, pollutant uptake by vegetation does not occur in the overlying wet pool (Minton, 2002). Placement of wetland plants in gravel with the stormwater flowing directly through the root system forces uptake by the vegetation. To maintain performance therefore requires annual or harvesting of the vegetation (See Maintenance). However, the removal of dissolved phosphorus, metals, and complex organics like pesticides in earthen-lined ponds and wetlands is primarily by chemical sorption or precipitation with the soil, not uptake by plants (Minton, 2002). Gravel substrate does not provide ideal conditions for these chemical processes. There are currently no operating data for the manufactured wetland with respect to the removal of dissolved pollutants and therefore whether uptake solely by plants is sufficient is unknown. It may be desirable to augment the gravel with media capable of removing dissolved pollutants. The supplemental media can be specific for the pollutant that is to be removed. Table 1 lists media that have been evaluated in either stormwater or wastewater constructed wetlands or filtration systems.

The gravel substrate likely provides a good environment for bacteria, facilitating the removal of nitrogen (its primary mechanism of removal) and the degradation of petroleum and other organic compounds. While this has been confirmed to occur in the manufactured product discussed here, experience with constructed wetlands used for wastewater treatment (Minton, 2002) suggests that it likely occurs

### **Siting Criteria**

While not stated by the manufacturer, the system is likely most appropriate for small drainage areas of an approximately an acre or less, given the number of units required per acre.

### **Additional Design Guidelines**

As noted previously, the number of units installed is the function of the volume of water to be treated: multiple units are installed in parallel with incoming stormwater split via a manifold. The storage volume of one unit is approximately 185 ft<sup>3</sup>. The recommended emptying rate is 0.25 gallons per minute (average). To illustrate sizing, assume a development site of one acre and the design event is 0.75 inches. The total volume of the design event is 2,722 cubic feet. Thus, a minimum of 15 units is required, ignoring throughput during the storm. At this rate, a unit drains in approximately 3.8 days.

However, the emptying time must be considered with respect to the inter-event time between storms. If the emptying time is too great there is a statistical probability of some water being present in the units when the next storm occurs. If so, the full volume of the design event is not treated over the long term. The manufacturer currently does not provide a design method that

considers this factor. The recommended approach is to use the method presented in TC-22 for Extended Detention systems inasmuch as the Storm Treat is a “fill-and-draw” system that functions like Extended Detention and should be expected to capture and treat the same stormwater volume over time.

Fewer units are possible if the upstream drainage system is able to store water, although this extends the emptying time. If a detention facility is required for flow control, it can provide the necessary storage and the number of wetland units is reduced, but not substantially given the need to drain the system in a timely fashion. Furthermore, if a detention facility is included it must control the release rate, not the manufactured wetland. This may require a more rapid release rate than recommended by the manufacturer. However, there are no data relating emptying rate with performance. Since the system also functions in effect as a horizontal filter, throughput rates higher than what is recommended by the manufacturer may be possible without a significant reduction in performance.

### **Maintenance**

To maximize the benefits of wetland vegetation in its removal of pollutants, the vegetation must be harvested each growth season. Harvesting is particularly important with respect to the removal of phosphorus and metals, less so nitrogen. Harvesting should occur by mid-summer before the plants begin to transfer phosphorus from the aboveground foliage to subsurface roots, or begin to lose metals that desorb during plant die-off. While not stated by the manufacturer, it is also desirable that every few years the entire plant mass including roots is harvested. This is because the belowground biomass constitutes a significant reservoir (possibly half) of the nutrients and metals that are removed from the stormwater by plants (Minton, 2002). Annual maintenance is typical.

If debris and floatable material is not effectively removed in the pretreatment unit, premature clogging of the debris bag may occur.

- Crop vegetation near end of each growth season to capture the nutrients and pollutants removed by the wetland vegetation.
- Inspect periodically to ensure that invasive species of wetland plants is not occurring
- Conduct inspection during the dry season to determine if irrigation of plants is necessary
- Clean center well periodically.

### **Cost**

Manufacturers provide costs for the units including delivery. Installation costs are generally on the order of 50 to 100 % of the manufacturer’s cost.

### ***Cost Considerations***

- If the drainage system lacks drain inlets with sumps where coarse sediments and floatables are removed, it is desirable to include a pretreatment unit for this purpose such as a manhole or wet vault of suitable size. This should be factored in the cost-analysis when comparing to other treatment BMPs. If already a requirement of the local government, a detention facility for flow control can serve this purpose.

- In comparison to public domain wet ponds (TC-20) and constructed wetlands (TC-21), vegetation harvesting is simpler, and therefore less costly.

## References and Sources of Additional Information

Ayoub, G.M., B. Koopman, and N. Pandya, 2001, Iron and aluminum hydroxy (oxide) coated filter media for low-concentration phosphorus removal, *Water Environ. Res.*, 73, 7, 478

Groffman, A., S. Peterson, D. Brookins, 1997, The removal of lead and other heavy metals from wastewater streams using zeolites, zeocarb, and other natural materials as a sorption media, presented to the 70th Annual Conference, Water Environment Federation, Alexandria, Virginia

James, B.R., M.C. Rabvenhorst, and G.A. Frigon, 1992, Phosphorus sorption by peat and sand amended with iron oxides or steel wool, *Water Environ. Res.*, 64, 699. Manufacturer's literature Metcalf and Eddy, Inc., 2002, *Wastewater Engineering: Treatment, Disposal, Reuse*, McGraw-Hill, New York, New York. Minton, G.R., 2002, *Stormwater Treatment: Biological, Chemical, and Engineering Principles*, RPA Press, Seattle, Washington, 416 pages. Netzer, A., and D.E. Hughes, 1984, Adsorption of copper, lead, and cobalt by activated carbon, *Water Res.*, 18, 927. Shapiro and Associates and the Bellevue Utilities Department, 1999, Lakemont stormwater treatment facility monitoring report, Bellevue, Washington.



## Description

Stormwater media filters are usually two-chambered including a pretreatment settling basin and a filter bed filled with sand or other absorptive filtering media. As stormwater flows into the first chamber, large particles settle out, and then finer particles and other pollutants are removed as stormwater flows through the filtering media in the second chamber.

There are currently three manufacturers of stormwater filter systems. Two are similar in that they use cartridges of a standard size. The cartridges are placed in vaults; the number of cartridges a function of the design flow rate. The water flows laterally (horizontally) into the cartridge to a centerwell, then downward to an underdrain system. The third product is a flatbed filter, similar in appearance to sand filters.

## California Experience

There are currently about 75 facilities in California that use manufactured filters.

## Advantages

- Requires a smaller area than standard flatbed sand filters, wet ponds, and constructed wetlands.
- There is no standing water in the units between storms, minimizing but does not entirely eliminate the opportunity for mosquito breeding.
- Media capable of removing dissolved pollutants can be selected.
- One system utilizes media in layers, allowing for selective removal of pollutants.
- The modular concept allows the design engineer to more closely match the size of the facility to the design storm.

## Limitations

- As some of the manufactured filter systems function at higher flow rates and/or have larger media than found in flatbed filters, the former may not provide the same level of performance as standard sand filters. However, the level of treatment may still be satisfactory.
- As with all filtration systems, use in catchments that have significant areas of non-stabilized soils can lead to premature clogging.

## Design Considerations

- Design Storm
- Media Type
- Maintenance Requirement

## Targeted Constituents

- Sediment
- Nutrients
- Trash
- Metals
- Bacteria
- Oil and Grease
- Organics

### Removal Effectiveness

See New Development and Redevelopment Handbook-Section 5.



## Design and Sizing Guidelines

There are currently three manufacturers of stormwater filter systems.

**Filter System A:** This system is similar in appearance to a slow-rate sand filter. However, the media is cellulose material treated to enhance its ability to remove hydrocarbons and other organic compounds. The media depth is 12 inches (30 cm). It operates at a very high rate, 20 gpm/ft<sup>2</sup> at peak flows. Normal operating rates are much lower assuming that the stormwater covers the entire bed at flows less than the peak rate. The system uses vortex separation for pretreatment. As the media is intended to remove sediments (with attached pollutants) and organic compounds, it would not be expected to remove dissolved pollutants such as nutrients and metals unless they are complexed with the organic compounds that are removed.

**Filter System B:** It uses a simple vertical filter consisting of 3 inch diameter, 30 inch high slotted plastic pipe wrapped with fabric. The standard fabric has nominal openings of 10 microns. The stormwater flows into the vertical filter pipes and out through an underdrain system. Several units are placed vertically at 1 foot intervals to give the desired capacity. Pretreatment is typically a dry extended detention basin, with a detention time of about 30 hours. Stormwater is retained in the basin by a bladder that is automatically inflated when rainfall begins. This action starts a timer which opens the bladder 30 hours later. The filter bay has an emptying time of 12 to 24 hours, or about 1 to 2 gpm/ft<sup>2</sup> of filter area. This provides a total elapsed time of 42 to 54 hours. Given that the media is fabric, the system does not remove dissolved pollutants. It does remove pollutants attached to the sediment that is removed.

**Filter System C:** The system use vertical cartridges in which stormwater enters radially to a center well within the filter unit, flowing downward to an underdrain system. Flow is controlled by a passive float valve system, which prevents water from passing through the cartridge until the water level in the vault rises to the top of the cartridge. Full use of the entire filter surface area and the volume of the cartridge is assured by a passive siphon mechanism as the water surface recedes below the top of the cartridge. A balance between hydrostatic forces assures a more or less equal flow potential across the vertical face of the filter surface. Hence, the filter surface receives suspended solids evenly. Absent the float valve and siphon systems, the amount of water treated over time per unit area in a vertical filter is not constant, decreasing with the filter height; furthermore, a filter would clog unevenly. Restriction of the flow using orifices ensures consistent hydraulic conductivity of the cartridge as a whole by allowing the orifice, rather than the media, whose hydraulic conductivity decreases over time, to control flow.

The manufacturer offers several media used singly or in combination (dual- or multi-media). Total media thickness is about 7 inches. Some media, such as fabric and perlite, remove only suspended solids (with attached pollutants). Media that also remove dissolved include compost, zeolite, and iron-infused polymer. Pretreatment occurs in an upstream unit and/or the vault within which the cartridges are located.

Water quality volume or flow rate (depending on the particular product) is determined by local governments or sized so that 85% of the annual runoff volume is treated.

## Construction/Inspection Considerations

- Inspect one or more times as necessary during the first wet season of operation to be certain that it is draining properly.



## Performance

The mechanisms of pollutant removal are essentially the same as with public domain filters (TC-40) if of a similar design. Whether removal of dissolved pollutants occurs depends on the media. Perlite and fabric do not remove dissolved pollutants, whereas for examples, zeolites, compost, activated carbon, and peat have this capability.

As most manufactured filter systems function at higher flow rates and have larger media than found in flatbed filters, they may not provide the same level of performance as standard sand filters. However, the level of treatment may still be satisfactory.

## Siting Criteria

There are no unique siting criteria.

## Additional Design Guidelines

Follow guidelines provided by the manufacturer.

## Maintenance

- Maintenance activities and frequencies are specific to each product. Annual maintenance is typical.
- Manufactured filters, like standard filters (TC-40), require more frequent maintenance than most standard treatment systems like wet ponds and constructed wetlands, typically annually for most sites.
- Pretreatment systems that may precede the filter unit should be maintained at a frequency specified for the particular process.

## Cost

Manufacturers provide costs for the units including delivery. Installation costs are generally on the order of 50 to 100 % of the manufacturer's costs.

### *Cost Considerations*

- Filters are generally more expensive to maintain than swales, ponds, and basins.
- The modularity of the manufactured systems allows the design engineer to closely match the capacity of the facility to the design storm, more so than with most other manufactured products.

## References and Sources of Additional Information

Minton, G.R., 2002, Stormwater Treatment: Biological, Chemical, and Engineering Principles, RPA Press, 416 pages.



## Description

Vortex separators: (alternatively, swirl concentrators) are gravity separators, and in principle are essentially wet vaults. The difference from wet vaults, however, is that the vortex separator is round, rather than rectangular, and the water moves in a centrifugal fashion before exiting. By having the water move in a circular fashion, rather than a straight line as is the case with a standard wet vault, it is possible to obtain significant removal of suspended sediments and attached pollutants with less space. Vortex separators were originally developed for combined sewer overflows (CSOs), where it is used primarily to remove coarse inorganic solids. Vortex separation has been adapted to stormwater treatment by several manufacturers.

## California Experience

There are currently about 100 installations in California.

## Advantages

- May provide the desired performance in less space and therefore less cost.
- May be more cost-effective pre-treatment devices than traditional wet or dry basins.
- Mosquito control may be less of an issue than with traditional wet basins.

## Limitations

- As some of the systems have standing water that remains between storms, there is concern about mosquito breeding.
- It is likely that vortex separators are not as effective as wet vaults at removing fine sediments, on the order 50 to 100 microns in diameter and less.
- The area served is limited by the capacity of the largest models.
- As the products come in standard sizes, the facilities will be oversized in many cases relative to the design treatment storm, increasing the cost.
- The non-steady flows of stormwater decreases the efficiency of vortex separators from what may be estimated or determined from testing under constant flow.
- Do not remove dissolved pollutants.

## Design Considerations

- Service Area
- Settling Velocity
- Appropriate Sizing
- Inlet Pipe Diameter

## Targeted Constituents

- Sediment ▲
- Nutrients ●
- Trash
- Metals ●
- Bacteria
- Oil and Grease
- Organics

Legend (*Removal Effectiveness*)

- Low
- High
- ▲ Medium



- A loss of dissolved pollutants may occur as accumulated organic matter (e.g., leaves) decomposes in the units.

### Design and Sizing Guidelines

The stormwater enters, typically below the effluent line, tangentially into the basin, thereby imparting a circular motion in the system. Due to centrifugal forces created by the circular motion, the suspended particles move to the center of the device where they settle to the bottom. There are two general types of vortex separation: free vortex and dampened (or impeded) vortex. Free vortex separation becomes dampened vortex separation by the placement of radial baffles on the weir-plate that impede the free vortex-flow pattern

It has been stated with respect to CSOs that the practical lower limit of vortex separation is a particle with a settling velocity of 12 to 16.5 feet per hour (0.10 to 0.14 cm/s). As such, the focus for vortex separation in CSOs has been with settleable solids generally 200 microns and larger, given the presence of the lighter organic solids. For inorganic sediment, the above settling velocity range represents a particle diameter of 50 to 100 microns. Head loss is a function of the size of the target particle. At 200 microns it is normally minor but increases significantly if the goal is to remove smaller particles.

The commercial separators applied to stormwater treatment vary considerably with respect to geometry, and the inclusion of radial baffles and internal circular chambers. At one extreme is the inclusion of a chamber within the round concentrator. Water flows initially around the perimeter between the inner and outer chambers, and then into the inner chamber, giving rise to a sudden change in velocity that purportedly enhances removal efficiency. The opposite extreme is to introduce the water tangentially into a round manhole with no internal parts of any kind except for an outlet hood. Whether the inclusion of chambers and baffles gives better performance is unknown. Some contend that free vortex, also identified as swirl concentration, creates less turbulence thereby increasing removal efficiency. One product is unique in that it includes a static separator screen.

- Sizing is based on the peak flow of the design treatment event as specified by local government.
- If an in-line facility, the design peak flow is four times the peak of the design treatment event.
- If an off-line facility, the design peak flow is equal to the peak of the design treatment event.
- Headloss differs with the product and the model but is generally on the order of one foot or less in most cases.

### ***Construction/Inspection Considerations***

No special considerations.

### Performance

Manufacturer's differ with respect to performance claims, but a general statement is that the manufacturer's design and rated capacity (cfs) for each model is based on and believed to achieve an aggregate reduction of 90% of all particles with a specific gravity of 2.65 (glacial sand) down to 150 microns, and to capture the floatables, and oil and grease. Laboratory tests of

two products support this claim. The stated performance expectation therefore implies that a lesser removal efficiency is obtained with particles less than 150 microns, and the lighter, organic settleables. Laboratory tests of one of the products found about 60% removal of 50 micron sand at the expected average operating flow rate

Experience with the use of vortex separators for treating combined sewer overflows (CSOs), the original application of this technology, suggests that the lower practical limit for particle removal are particles with a settling velocity of 12 feet per hour (Sullivan, 1982), which represents a particle diameter of 100 to 200 microns, depending on the specific gravity of the particle. The CSO experience therefore seems consistent with the limited experience with treating stormwater, summarized above

Traditional treatment technologies such as wet ponds and extended detention basins are generally believed to be more effective at removing very small particles, down to the range of 10 to 20 microns. Hence, it is intuitively expected that vortex separators do not perform as well as the traditional wet and dry basins, and filters. Whether this matters depends on the particle size distribution of the sediments in stormwater. If the distribution leans towards small material, there should be a marked difference between vortex separators and, say, traditional wet vaults. There are little data to support this conjecture

In comparison to other treatment technologies, such as wet ponds and grass swales, there are few studies of vortex separators. Only two of manufactured products currently available have been field tested. Two field studies have been conducted. Both achieved in excess of 80% removal of TSS. However, the test was conducted in the Northeast (New York state and Maine) where it is possible the stormwater contained significant quantities of deicing sand. Consequently, the influent TSS concentrations and particle size are both likely considerably higher than is found in California stormwater. These data suggest that if the stormwater particles are for the most part fine (i.e., less than 50 microns), vortex separators will not be as efficient as traditional treatment BMPs such as wet ponds and swales, if the latter are sized according to the recommendations of this handbook.

There are no equations that provide a straightforward determination of efficiency as a function of unit configuration and size. Design specifications of commercial separators are derived from empirical equations that are unique and proprietary to each manufacturer. However, some general relationships between performance and the geometry of a separator have been developed. CSO studies have found that the primary determinants of performance of vortex separators are the diameters of the inlet pipe and chamber with all other geometry proportional to these two.

Sullivan et al. (1982) found that performance is related to the ratios of chamber to inlet diameters,  $D_2/D_1$ , and height between the inlet and outlet and the inlet diameter,  $H_1/D_1$ , shown in Figure 3. The relationships are: as  $D_2/D_1$  approaches one, the efficiency decreases; and, as the  $H_1/D_1$  ratio decreases, the efficiency decreases. These relationships may allow qualitative comparisons of the alternative designs of manufacturers. Engineers who wish to apply these concepts should review relevant publications presented in the References.

## Siting Criteria

There are no particularly unique siting criteria. The size of the drainage area that can be served by vortex separators is directly related to the capacities of the largest models.

**Additional Design Guidelines**

Vortex separators have two capacities if positioned as in-line facilities, a treatment capacity and a hydraulic capacity. Failure to recognize the difference between the two may lead to significant under sizing; i.e., too small a model is selected. This observation is relevant to three of the five products. These three technologies all are designed to experience a unit flow rate of about 24 gallons/square foot of separator footprint at the peak of the design treatment event. This is the horizontal area of the separator zone within the container, not the total footprint of the unit. At this unit flow rate, laboratory tests by these manufacturers have established that the performance will meet the general claims previously described. However, the units are sized to handle 100 gallons/square foot at the peak of the hydraulic event. Hence, in selecting a particular model the design engineer must be certain to match the peak flow of the design event to the stated treatment capacity, not the hydraulic capacity. The former is one-fourth the latter. If the unit is positioned as an off-line facility, the model selected is based on the capacity equal to the peak of the design treatment event.

**Maintenance**

Maintenance consists of the removal of accumulated material with an eductor truck. It may be necessary to remove and dispose the floatables separately due to the presence of petroleum product.

***Maintenance Requirements***

Remove all accumulated sediment, and litter and other floatables, annually, unless experience indicates the need for more or less frequent maintenance.

**Cost**

Manufacturers provide costs for the units including delivery. Installation costs are generally on the order of 50 to 100 % of the manufacturer's cost. For most sites the units are cleaned annually.

***Cost Considerations***

The different geometry of the several manufactured separators suggests that when comparing the costs of these systems to each other, that local conditions (e.g., groundwater levels) may affect the relative cost-effectiveness.

**References and Sources of Additional Information**

Field, R., 1972, The swirl concentrator as a combined sewer overflow regulator facility, EPA/R2-72-008, U.S. Environmental Protection Agency, Washington, D.C.

Field, R., D. Averill, T.P. O'Connor, and P. Steel, 1997, Vortex separation technology, Water Qual. Res. J. Canada, 32, 1, 185

Manufacturers technical materials

Sullivan, R.H., et al., 1982, Design manual – swirl and helical bend pollution control devices, EPA-600/8-82/013, U.S. Environmental Protection Agency, Washington, D.C.

Sullivan, R.H., M.M. Cohn, J.E. Ure, F.F. Parkinson, and G. Caliana, 1974, Relationship between diameter and height for the design of a swirl concentrator as a combined sewer overflow regulator, EPA 670/2-74-039, U.S. Environmental Protection Agency, Washington, D.C.

Sullivan, R.H., M.M. Cohn, J.E. Ure, F.F. Parkinson, and G. Caliana, 1974, The swirl concentrator as a grit separator device, EPA670/2-74-026, U.S. Environmental Protection Agency, Washington, D.C.

Sullivan, R.H., M.M. Cohn, J.E. Ure, F.F. Parkinson, and G. Caliana, 1978, Swirl primary separator device and pilot demonstration, EPA600/2-78-126, U.S. Environmental Protection Agency, Washington, D.C.





## Description

A wet vault is a vault with a permanent water pool, generally 3 to 5 feet deep. The vault may also have a constricted outlet that causes a temporary rise of the water level (i.e., extended detention) during each storm. This live volume generally drains within 12 to 48 hours after the end of each storm.

## California Experience

There are currently several hundred stormwater treatment facilities in California that use manufactured wet vaults currently in operation in California.

## Advantages

- Internal baffling and other design features such as bypasses may increase performance over traditional wet vaults and/or reduce the likelihood of resuspension and loss of sediments or floatables during high flows.
- Head loss is modest.

## Limitations

- Concern about mosquito breeding in standing water
- The area served is limited by the capacity of the largest models.
- As the products come in standard sizes, the facilities will be oversized in many cases relative to the design treatment storm, increasing the cost.
- Do not remove dissolved pollutants.
- A loss of dissolved pollutants may occur as accumulated organic matter (e.g., leaves) decomposes in the units.

## Design and Sizing Guidelines

Water quality volume or flow rate (depending on the particular product) is determined by local governments or sized so that 85% of the annual runoff volume is treated. There are three general configurations of wet vaults currently available, differing with the particular manufacturer.

**Vault System A:** This system consists of two standard precast manholes, the size varying to achieve the desired capacity. Stormwater enters the first (primary) manhole where coarse solids are removed. The stormwater flows from the first to the second (storage) manhole, carrying floatables where they are captured and retained. Further sedimentation occurs in this second manhole. The off-line serves as a storage reservoir for

## Design Considerations

- Hydraulic Capacity
- Sediment Accumulation

## Targeted Constituents

- Sediment
- Nutrients
- Trash
- Metals
- Bacteria
- Oil and Grease
- Organics

### Removal Effectiveness

See New Development and Redevelopment Handbook-Section 5.



floatables as stormwater flows through at flow rates less than the design flow. A patented device controls the flow into the storage manhole. All flows above the stated treatment flow rate bypass through the device. The bypass prevents resuspension or loss of sediment and floatables that have accumulated in the second manhole. It is important to recognize that has storage of accumulated sediment occurs directly in the operating area of the manholes; treatment efficiency will decline over time given the reduction in treatment volume

The manufacturer currently provides 4 models, with treatment capacities (flow rate above which bypass occurs) from 2.4 to 21.8 cfs. The hydraulic capacities range from 10 to 100 cfs. As such, all stormwater achieves at least partial treatment through essentially all but the most extreme storm flows since some settling occurs in the first manhole. The manufacturer provides information on the total system (water) volume, sediment capacity, and floatable capacities. The size of the storage manhole can be varied with each of the four models to increase storage capacity as desired, following recommendations of the manufacturer. The footprint of this system ranges from about 200 to 350 ft<sup>2</sup>, with heights of about 11.5 to 13.5 feet (excluding minimum soil cover and access port extenders), depending on the model. Head loss ranges from 5 to 12 inches, depending on the model. Sediment and floatable capacities range up to 201 cf and 150 gallons, respectively. The recommended point of maintenance is when about 25% of the wet pool volume is supplanted by sediment. The affect of the accumulation of sediment on performance is not given

**Vault System B:** This wet vault has outward appearance of a standard, rectangular wet vault, but with its own unique design for internal baffles. Included is an entrance baffle, presumably to reduce the energy of the flow entering the unit. Baffles are also affixed to the floor, purportedly to reduce resuspension of settled sediments improve performance. A floating sorbent pad may be placed near the outlet to remove free oil floating on the surface. The vault includes both a permanent wet pool, 3 feet in depth, and live storage volume that is filled during each storm. The live storage volume is accomplished by restricting the outlet. The system is modular: that is, it consists of standard units that are added to increase the length, thereby providing the desired volume. Presumably for very large sites there is a practical total length. Further capacity could be accomplished by having two or more vaults in parallel. The capacity of the system is therefore essentially unlimited, Being modular may allow the design engineer to more closely match facility size to the design event.

**Vault System C:** This system is like System A, but differs in two primary respects. The Stormceptor module consists of only one circular structure. Hence, standard precast manholes can be used for the smaller models but larger models are non-standard sizes. Like System A, System C has an internal bypass, involving a unique design. The purpose of the bypass is to prevent resuspension of previously suspended material. All stormwater up to the bypass rate is diverted downward into the center well where removal occurs. Flows in excess of the treatment capacity are diverted directly across the top of the device to the outlet. According to the manufacturer there is also some storage capacity for floatables immediately beneath the bypass structure.

Twelve models are available. The treatment capacity of each is not indicated for the Stormceptor as it is a function of the removal efficiency specified by the designer. The manufacturer provides a methodology for the calculation of efficiency as a function of flow rate (see Design Guidelines). Hydraulic capacities range up to approximately 63 cfs. The head requirement is a function of the model and desired hydraulic flow rate, ranging up to 21 inches.

Diameters range from 4 to 12 feet, and minimum heights up to about 13 feet plus the diameter of the incoming pipe. Sediment and floatable capacities range up to 1,470 cf and 3,055 gallons, respectively. The recommended point of maintenance is when about 15% of the wet pool volume is supplanted by sediment. The affect of the accumulation of sediment on performance is not given but can be estimated using the manufacturer's sizing methodology.

### ***Construction/Inspection Considerations***

Refer to guidelines provided by the manufacturer.

### **Performance**

A manufactured wet vault can be expected to perform similarly to large catch basins in that its wet volume (dead storage) is similar to that determined by methodology provided in TC-20 for wet ponds. Hence, the engineer should compare the volume of the model s/he intends to select to what the volume of a constructed wet vault would be for the site. Conceivably, manufactured vaults may give better performance than standard catch basins, given the inclusion of design elements that are intended to minimize resuspension. Given this benefit, it could be argued that manufactured wet vaults can be smaller than traditional catch basins, to achieve similar performance. However, there are no data indicating the incremental benefit of the particular design elements of each manufactured product.

### **Siting Criteria**

There are no unique siting criteria. The size of the drainage area that can be served by a manufactured wet vault is directly related to the capacities of the largest models.

### **Additional Design Guidelines**

Refer to guidelines of the manufacturers.

### **Maintenance**

Maintenance consists of the removal of accumulated material with an eductor truck. It may be necessary to remove and dispose the floatables separately due to the presence of petroleum product. Annual maintenance is typical.

It is important to recognize that as storage of accumulated sediment occurs directly in the operating area of the wet vault, treatment efficiency will decline over time given the reduction in treatment volume. Whether this is significant depends on the design capacity. If the total volume of the wet pool is similar to that determined by the method on TC-20, the effect on performance is minor.

### ***Maintenance Requirements***

- Each manufacturer provides storage capacities with respect to sediments and floatables, with recommendations on the frequency of cleaning as a function of the percentage of the volume in the unit that has been filled by these materials.
- The recommended frequency of cleaning differs with the manufacturer, ranging from one to two years. It is prudent to inspect the unit twice during the first wet season of operation, setting the cleaning frequency accordingly.

## Cost

Manufacturers provide costs for the units including delivery. Installation costs are generally on the order of 50 to 100 % of the manufacturer's cost.

### ***Cost Considerations***

- The different geometries of the several manufactured separators suggest that when comparing the costs of these systems to each other, that local conditions (e.g., groundwater levels) may affect the relative cost-effectiveness.
- Subsurface facilities are more expensive to construct than surface facilities of similar size. However, the added cost of construction is in many developments offset by the value of continued use of the land.
- Some of the manufactured vaults may be less expensive to maintain than public domain vaults as the former may be cleaned without the need for confined space entry.
- Subsurface facilities do not require landscaping, reducing maintenance costs accordingly.

### **References and Sources of Additional Information**

Manufacturers literature.

## Description

Drain inserts are manufactured filters or fabric placed in a drop inlet to remove sediment and debris. There are a multitude of inserts of various shapes and configurations, typically falling into one of three different groups: socks, boxes, and trays. The sock consists of a fabric, usually constructed of polypropylene. The fabric may be attached to a frame or the grate of the inlet holds the sock. Socks are meant for vertical (drop) inlets. Boxes are constructed of plastic or wire mesh. Typically a polypropylene “bag” is placed in the wire mesh box. The bag takes the form of the box. Most box products are one box; that is, the setting area and filtration through media occur in the same box. Some products consist of one or more trays or mesh grates. The trays may hold different types of media. Filtration media vary by manufacturer. Types include polypropylene, porous polymer, treated cellulose, and activated carbon.

## California Experience

The number of installations is unknown but likely exceeds a thousand. Some users have reported that these systems require considerable maintenance to prevent plugging and bypass.

## Advantages

- Does not require additional space as inserts as the drain inlets are already a component of the standard drainage systems.
- Easy access for inspection and maintenance.
- As there is no standing water, there is little concern for mosquito breeding.
- A relatively inexpensive retrofit option.

## Limitations

Performance is likely significantly less than treatment systems that are located at the end of the drainage system such as ponds and vaults. Usually not suitable for large areas or areas with trash or leaves than can plug the insert.

## Design and Sizing Guidelines

Refer to manufacturer’s guidelines. Drain inserts come in many configurations but can be placed into three general groups: socks, boxes, and trays. The sock consists of a fabric, usually constructed of polypropylene. The fabric may be attached to a frame or the grate of the inlet holds the sock. Socks are meant for vertical (drop) inlets. Boxes are constructed of plastic or wire mesh. Typically a polypropylene “bag” is placed in the wire mesh box. The bag takes the form of the box. Most box products are

## Design Considerations

- Use with other BMPs
- Fit and Seal Capacity within Inlet

## Targeted Constituents

- Sediment
- Nutrients
- Trash
- Metals
- Bacteria
- Oil and Grease
- Organics

### Removal Effectiveness

See New Development and Redevelopment Handbook-Section 5.



one box; that is, the setting area and filtration through media occurs in the same box. One manufacturer has a double-box. Stormwater enters the first box where setting occurs. The stormwater flows into the second box where the filter media is located. Some products consist of one or more trays or mesh grates. The trays can hold different types of media. Filtration media vary with the manufacturer: types include polypropylene, porous polymer, treated cellulose, and activated carbon.

### ***Construction/Inspection Considerations***

Be certain that installation is done in a manner that makes certain that the stormwater enters the unit and does not leak around the perimeter. Leakage between the frame of the insert and the frame of the drain inlet can easily occur with vertical (drop) inlets.

### **Performance**

Few products have performance data collected under field conditions.

### **Siting Criteria**

It is recommended that inserts be used only for retrofit situations or as pretreatment where other treatment BMPs presented in this section area used.

### **Additional Design Guidelines**

Follow guidelines provided by individual manufacturers.

### **Maintenance**

Likely require frequent maintenance, on the order of several times per year.

### **Cost**

- The initial cost of individual inserts ranges from less than \$100 to about \$2,000. The cost of using multiple units in curb inlet drains varies with the size of the inlet.
- The low cost of inserts may tend to favor the use of these systems over other, more effective treatment BMPs. However, the low cost of each unit may be offset by the number of units that are required, more frequent maintenance, and the shorter structural life (and therefore replacement).

### **References and Sources of Additional Information**

Hrachovec, R., and G. Minton, 2001, Field testing of a sock-type catch basin insert, Planet CPR, Seattle, Washington

Interagency Catch Basin Insert Committee, Evaluation of Commercially-Available Catch Basin Inserts for the Treatment of Stormwater Runoff from Developed Sites, 1995

Larry Walker Associates, June 1998, NDMP Inlet/In-Line Control Measure Study Report

Manufacturers literature

Santa Monica (City), Santa Monica Bay Municipal Stormwater/Urban Runoff Project - Evaluation of Potential Catch basin Retrofits, Woodward Clyde, September 24, 1998

Woodward Clyde, June 11, 1996, Parking Lot Monitoring Report, Santa Clara Valley Nonpoint Source Pollution Control Program.





# Section 6

## Long-term Maintenance of BMPs

### 6.1 Introduction

The long-term performance of BMPs hinges on ongoing and proper maintenance. In order for this to occur, detailed maintenance plans are needed that include specific maintenance activities and frequencies for each type of BMP. In addition, these should include indicators for assessing when “as needed” maintenance activities are required. The fact sheets included in this volume contain the basic information needed to develop these maintenance plans, but municipalities and other regulatory agencies also need to identify the responsible party and potentially to address funding requirements. The following discussion is based primarily on data developed by Horner et al. (1994) and information available at <http://www.stormwatercenter.net/>

### 6.2 Critical Regulatory Components

Critical regulatory components identified by Horner et al. (1994) include:

- Regulations should officially designate a responsible party, frequently the development site owner, to have ultimate responsibility for the continued maintenance of stormwater facilities. This official designation provides the opportunity for appropriate preparation and budgeting prior to actually assuming responsibilities. It also facilitates enforcement or other legal remedies necessary to address compliance or performance problems once the facility has been constructed.
- Regulations should clearly state the inspection and maintenance requirements. Inspection and maintenance requirements should also comply with all applicable statutes and be based on the needs and priorities of the individual measure or facility. A clear presentation will help owners and builders comply, and inspectors enforce requirements.
- Regulations should contain comprehensive requirements for documenting and detailing maintenance. A facility operation and maintenance manual should be prepared containing accurate and comprehensive drawings or plans of the completed facility and detailed descriptions and schedules of inspection and maintenance.
- The regulations should delineate the procedure for maintenance noncompliance. This process should provide informal, discretionary measures to deal with periodic, inadvertent noncompliance and formal and severe measures to address chronic noncompliance or performance problems. In either case, the primary goal of enforcement is to maintain an effective BMP – the enforcement action should not become an end in itself.
- Regulations should also address the possibility of total default by the owner or builder by providing a way to complete construction and continue maintenance. For example, the public might assume maintenance responsibility. If so, the designated public agency must be alerted and possess the necessary staffing, equipment, expertise, and funding to assume this responsibility. Default can be addressed through bonds and other performance

guarantees obtained before the project is approved and construction begins. These bonds can then be used to fund the necessary maintenance activities.

- The regulations must recognize that adequate and secure funding is needed for facility inspection and maintenance, and provide for such funding.

## 6.3 Enforcement Options

A public agency will sometimes need to compel those responsible for facility construction or maintenance to fulfill their obligations. Therefore, the maintenance program must have enforcement options for quick corrective action. Rather than a single enforcement measure, the program should have a variety of techniques, each with its own degree of formality and legal weight. The inspection program should provide for nonconforming performance and even default, and contain suitable means to address all stages.

Prior to receiving construction approval, the developer or builder can be forced to provide performance guarantees. The public agency overseeing the construction can use these guarantees, usually a performance bond or other surety in an amount equal to some fraction of the facility's construction cost, to fund maintenance activities.

Enforcement of maintenance requirements can be accomplished through a stormwater maintenance agreement, which is a formal contract between a local government and a property owner designed to guarantee that specific maintenance functions are performed in exchange for permission to develop that property (<http://www.stormwatercenter.net/>). Local governments benefit from these agreements in that responsibility for regular maintenance of the BMPs can be placed upon the property owner or other legally recognized party, allowing agency staff more time for plan review and inspection.

## 6.4 Maintenance Agreements

Maintenance agreements can be an effective tool for ensuring long-term maintenance of on-site BMPs. The most important aspect of creating these maintenance agreements is to clearly define the responsibilities of each party entering into the agreement. Basic language that should be incorporated into an agreement includes the following:

### 1. Performance of Routine Maintenance

Local governments often find it easier to have a property owner perform all maintenance according to the requirements of a Design Manual. Other communities require that property owners do aesthetic maintenance (i.e., mowing, vegetation removal) and implement pollution prevention plans, but elect to perform structural maintenance and sediment removal themselves.

### 2. Maintenance Schedules

Maintenance requirements may vary, but usually governments require that all BMP owners perform at least an annual inspection and document the maintenance and repairs performed. An annual report must then be submitted to the government, who may then choose to perform an inspection of the facility.

### **3. Inspection Requirements**

Local governments may obligate themselves to perform an annual inspection of a BMP, or may choose to inspect when deemed necessary instead. Local governments may also wish to include language allowing maintenance requirements to be increased if deemed necessary to ensure proper functioning of the BMP.

### **4. Access to BMPs**

The agreement should grant permission to a local government or its authorized agent to enter onto property to inspect BMPs. If deficiencies are noted, the government should then provide a copy of the inspection report to the property owner and provide a timeline for repair of these deficiencies.

### **5. Failure to Maintain**

In the maintenance agreement, the government should repeat the steps available for addressing a failure to maintain situation. Language allowing access to BMPs cited as not properly maintained is essential, along with the right to charge any costs for repairs back to the property owner. The government may wish to include deadlines for repayment of maintenance costs, and provide for liens against property up to the cost of the maintenance plus interest.

### **6. Recording Of The Maintenance Agreement**

An important aspect to the recording of the maintenance agreement is that the agreement be recorded into local deed records. This helps ensure that the maintenance agreement is bound to the property in perpetuity.

Finally, some communities elect to include easement requirements into their maintenance agreements. While easement agreements are often secured through a separate legal agreement, recording public access easements for maintenance in a maintenance agreement reinforces a local government's right to enter and inspect a BMP.

Examples of maintenance agreements include several available on the web at <http://www.stormwatercenter.net/>

## **6.5 Public Funding Sources**

If local agencies are willing to assume responsibility for stormwater BMPs, it is essential to identify the long-term funding sources. Several of these are described below:

### **General Tax Revenues**

Tax revenues are an obvious source of funding, particularly for the long-term inspection and maintenance of existing runoff and drainage facilities. The benefits and protection to the public from continued safe and effective operation of the facility justifies using revenues from general funds.

To use tax revenues, particularly from a general fund, the inspection and maintenance program must annually compete with all other programs included in the government's annual operating budget. This inconsistent and unreliable funding makes securing a long-term financial

commitment to inspection and maintenance difficult and subject to political pressures. Nevertheless, tax revenues remain a popular funding source because the collection and disbursement system is already in place and familiar.

### **Utility Charges**

Using utility charges to fund inspection and maintenance is a somewhat recent application of an already established financing technique. In addition, several municipalities and counties throughout the country have runoff management, drainage, and flood control authorities or districts to provide residents with runoff related services.

Using utility charge financing has several advantages. By addressing only runoff needs and benefits, utility funding avoids competing with other programs and needs. Utility funding also demonstrates a direct link between the funding and the services it provides. This approach can require an entirely new operating system and organization that needs legal authorization to exist, operate, and assess charges. The effort required to create such an entity can deter many, although the continued success of established authorities and growth of new ones have done much to allay concerns over the effort required.

In a runoff utility, the user charges are often based on the need for services rather than the benefits derived from them. While charges are based on actual costs to inspect and maintain runoff facilities and measures within the service area, the assessed rate structure should relate to site characteristics. These include property area size, extent of impervious coverage, and other factors with a direct and demonstrable effect on runoff. To be fair, the rate structure should also remain simple and understandable to the ratepayer.

To finance the stormwater utility in Prince William County, Virginia, residential and nonresidential owners of developed property pay based on the amount of impervious area (rooftops, paved areas, etc.) on their property. Residents pay \$10.38 billed twice a year (\$20.76 total annual fee) for detached single-family homes. Town home and condominium owners will pay \$7.785 billed twice a year (\$15.57 total annual fee). Nonresidential property owners pay \$0.84 per 1,000 ft<sup>2</sup> of impervious area per month. Fee adjustments or credits may be available if a stormwater management system is already in place. The fee will be on the real estate bills.

Fees for the stormwater utility in Austin, Texas are higher with residential users billed \$5.79/mo, while commercial users pay \$94.62/mo/acre of impervious cover. These fees cover not only maintenance of existing BMPs, but also capital improvement projects related to the drainage infrastructure.

### **Permit Fees**

Collecting permit fees to finance runoff inspection and maintenance is a long standing funding procedure. Most governmental entities, local, county, and state, can establish and collect fees and other charges to obtain operating funds for programs and services. Many inspection services, most notably the construction inspection of both ESC measures and permanent drainage and runoff management facilities, are financed at least in part through fees collected by permitting agencies. Unlike taxes or some utility charges, inspection costs are borne by those who need them.

The permit fee collection program should have a demonstrable link to the runoff management or drainage systems. The public agency should demonstrate a direct link between the permit fees collected and the permitted project. One method is using dedicated accounts for individual projects and facilities. Finally, the rate structure should reflect site characteristics such as area size or imperviousness that directly relate to the measure or facility by affecting runoff or erosion.

### **Dedicated Contributions**

Public agencies at times have used developer contributions to fund long-term facility maintenance. This approach is particularly appropriate in single-family residential subdivisions, where numerous individual property owners served by a single runoff facility can result in confusion over who has maintenance responsibility.

The exact funding technique depends on many factors, including community attitude and knowledge, economic and political viability, and program needs and costs. Some techniques, including permit fees and dedicated contributions, may be more appropriate for short-term activities, such as construction inspection. Other utility charges and specialized tax revenues may apply to all phases of an inspection and maintenance program but require considerable effort and special legal authorization to operate.



# Section 7

## Glossary and List of Acronyms

### 7.1 Glossary

**303(d) Listed:** Water bodies listed as impaired as per Section 303(d) of the 1972 Clean Water Act.

**Best Management Practices (BMPs):** Includes schedules of activities, prohibitions of practices, maintenance procedures, and other management practices to prevent, eliminate, or reduce the pollution of waters of the receiving waters. BMPs also include treatment requirements, operating procedures, and practices to control plant site runoff spillage or leaks, sludge or waste disposal, or drainage from raw material storage.

**Catch Basin (Also known as Inlet):** Box-like underground concrete structure with openings in curbs and gutters designed to collect runoff from streets and pavement.

**Clean Water Act (CWA):** (33 U.S.C. 1251 et seq.) requirements of the NPDES program are defined under Sections 307, 402, 318 and 405 of the CWA.

**Construction Activity:** Includes clearing, grading, excavation, and contractor activities that result in soil disturbance.

**Construction General Permit:** A National Pollutant Discharge Elimination System (NPDES) permit issued by the State Water Resources Control Board for the discharge of stormwater associated with construction activity from soil disturbance of five acres or more. Threshold lowered to one acre beginning October 10, 2003. Construction General Permit No. CAS000002.

**Denuded:** Land stripped of vegetation or land that has had its vegetation worn down due to the impacts from the elements or humans.

**Detention:** The capture and subsequent release of stormwater runoff from the site at a slower rate than it is collected, the difference being held in temporary storage.

**Discharge:** A release or flow of stormwater or other substance from a conveyance system or storage container. Broader – includes release to storm drains, etc.

**Effluent Limits:** Limitations on amounts of pollutants that may be contained in a discharge. Can be expressed in a number of ways including as a concentration, as a concentration over a time period (e.g., 30-day average must be less than 20 mg/l), or as a total mass per time unit, or as a narrative limit.

**Erosion:** The wearing away of land surface by wind or water. Erosion occurs naturally from weather or runoff but can be intensified by land-clearing practices related to farming, new development, redevelopment, road building, or timber cutting.

**Facility:** Is a collection of industrial processes discharging stormwater associated with industrial activity within the property boundary or operational unit.

**Grading:** The cutting or filling of the land surface to a desired slope or elevation.

**Hazardous Waste:** A waste or combination of wastes that, because of its quantity, concentration, or physical, chemical or infectious characteristics, may either cause or significantly contribute to an increase in mortality or an increase in serious irreversible illness; or pose a substantial present or potential hazard to human health or the environment when improperly treated, stored, transported, disposed of or otherwise managed. Possesses at least one of four characteristics (ignitability, corrosivity, reactivity, or toxicity) or appears on special EPA or state lists. Regulated under the federal Resource Conservation and Recovery Act and the California Health and Safety Code.

**Illicit Discharges:** Any discharge to a municipal separate storm sewer that is not in compliance with applicable laws and regulations as discussed in this document.

**Industrial General Permit:** A National Pollutant Discharge Elimination System (NPDES) Permit (No. CAS000001) issued by the State Water Resources Control Board for discharge of stormwater associated with industrial activity. Board Order 97-03-DWQ.

**Inlet:** An entrance into a ditch, storm drain, or other waterway.

**Integrated Pest Management (IPM):** An ecosystem-based strategy that focuses on long-term prevention of pests or their damage through a combination of techniques such as biological control, habitat manipulation, modification of cultural practices, and use of resistant varieties. Pesticides are used only after monitoring indicates they are needed according to established guidelines, and treatments are made with the goal of removing only the target organism.

**Municipal Separate Storm Sewer System (MS4):** A conveyance or system of conveyances (including roads with drainage systems, municipal streets, catch basins, curbs, gutters, ditches, man-made channels, or storm drains): (i) designed or used for collecting or conveying storm water; (ii) which is not a combined sewer; and (iii) which is not part of a Publicly Owned Treatment Works (POTW) as defined at Title 40 of the Code of Federal Regulations (CFR) 122.2. A “Small MS4” is defined as an MS4 that is not a permitted MS4 under the Phase I regulations. This definition of a Small MS4 applies to MS4 operated within cities and counties as well as governmental facilities that have a system of storm sewers.

**Non-Stormwater Discharge:** Any discharge to municipal separate storm sewer that is not composed entirely of stormwater.

**Nonpoint Source Pollution:** Pollution that does not come from a point source. Nonpoint source pollution originates from aerial diffuse sources that are mostly related to land use.

**Notice of Intent (NOI):** A formal notice to SWRCB submitted by the owner of an industrial site or construction site that said owner seeks coverage under a General Permit for discharges associated with industrial and construction activities. The NOI provides information on the



owner, location, type of project, and certifies that the owner will comply with the conditions of the construction General Permit.

**Notice of Termination (NOT):** Formal notice to SWRCB submitted by owner/ developer that a construction project is complete.

**NPDES Permit:** NPDES is an acronym for National Pollutant Discharge Elimination System. NPDES is the national program for administering and regulating Sections 307, 318, 402, and 405 of the Clean Water Act (CWA). In California, the State Water Resources Control Board (SWRCB) has issued a General Permit for stormwater discharges associated with industrial activities (see Appendix A).

**Outfall:** The end point where storm drains discharge water into a waterway.

**Point Source:** Any discernible, confined, and discrete conveyance from which pollutants are or may be discharged. This term does not include return flows from irrigated agriculture or agricultural stormwater runoff.

**Pollutant:** Generally, any substance introduced into the environment that adversely affects the usefulness of a resource.

**Pollution Prevention (P2):** Practices and actions that reduce or eliminate the generation of pollutants.

**Precipitation:** Any form of rain or snow.

**Pretreatment:** Treatment of waste stream before it is discharged to a collection system.

**Reclaim (water reclamation):** Planned use of treated effluent that would otherwise be discharged without being put to direct use.

**Retention:** The storage of stormwater to prevent it from leaving the development site.

**Reuse (water reuse):** (see Reclaim)

**Runoff:** Water originating from rainfall, melted snow, and other sources (e.g., sprinkler irrigation) that flows over the land surface to drainage facilities, rivers, streams, springs, seeps, ponds, lakes, and wetlands.

**Run-on:** Off site stormwater surface flow or other surface flow which enters your site.

**Scour:** The erosive and digging action in a watercourse caused by flowing water.

**Secondary Containment:** Structures, usually dikes or berms, surrounding tanks or other storage containers, designed to catch spilled materials from the storage containers.

**Sedimentation:** The process of depositing soil particles, clays, sands, or other sediments that were picked up by runoff.

**Sediments:** Soil, sand, and minerals washed from land into water, usually after rain, that collect in reservoirs, rivers, and harbors, destroying fish nesting areas and clouding the water, thus preventing sunlight from reaching aquatic plants. Farming, mining, and building activities without proper implementation of BMPs will expose sediment materials, allowing them to be washed off the land after rainfalls.

**Significant Materials:** Includes, but not limited to, raw materials; fuels; materials such as solvents, detergents, and plastic pellets; finished materials such as metallic products; raw materials used in food processing or production; hazardous substances designed under Section 101(14) of CERLCA; any chemical the facility is required to report pursuant to Section 313 of Title III of SARA; fertilizers; pesticides; and waste products such as ashes, slag, and sludge that have the potential to be released with stormwater discharges.

**Significant Quantities:** The volume, concentrations, or mass of a pollutant in stormwater discharge that can cause or threaten to cause pollution, contamination, or nuisance that adversely impact human health or the environment and cause or contribute to a violation of any applicable water quality standards for receiving water.

**Source Control BMPs:** Operational practices that reduce potential pollutants at the source.

**Source Reduction (also source control):** The technique of stopping and/ or reducing pollutants at their point of generation so that they do not come into contact with stormwater.

**Storm Drains:** Above- and below-ground structures for transporting stormwater to streams or outfalls for flood control purposes.

**Stormwater:** Defined as urban runoff and snowmelt runoff consisting only of those discharges, which originate from precipitation events. Stormwater is that portion of precipitation that flows across a surface to the storm drain system or receiving waters.

**Stormwater Discharge Associated with Industrial Activity:** Discharge from any conveyance which is used for collecting and conveying stormwater from an area that is directly related to manufacturing, processing, or raw materials storage activities at an industrial plant.

**Stormwater Pollution Control Plan (SWPCP):** A less formal plan than the SWPPP that addresses the implementation of BMPs at facilities/businesses not covered by a general permit but that have the potential to discharge pollutants.

**Stormwater Pollution Prevention Plan (SWPPP):** A written plan that documents the series of phases and activities that, first, characterizes your site, and then prompts you to select and carry out actions which prevent the pollution of stormwater discharges.

**Treatment Control BMPs:** Treatment methods to remove pollutants from stormwater.

**Toxicity:** Adverse responses of organisms to chemicals or physical agents ranging from mortality to physiological responses such as impaired reproduction or growth anomalies.

**Turbidity:** Describes the ability of light to pass through water. The cloudy appearance of water caused by suspended and colloidal matter (particles).

## 7.2 Acronyms

AASHTO	American Association of State Highway and Transportation Officials
AC	Asphalt Concrete
ADL	Aerially Deposited Lead
AIMP	Impervious Area
AINF	Infiltration Area
ANSI	American National Standards Institute
APHA	American Public Health Association
APWA	American Public Works Association
ARS	Agricultural Research Service
AQMD	Air Quality Management District
ASTM	American Society for Testing Materials
AWWA	American Water Works Association
BAT	Best Available Technology (economically available)
BCT	Best Conventional Technology (pollution control)
BFP	Bonded Fiber Matrix
BMPs	Best Management Practices
BOD	Biological Oxygen Demand
CA	Contractor Activities
CAL-EPA	California Environmental Protection Agency
CAL-OSHA	California Division of Occupational Safety and Health Administration
CASQA	California Stormwater Quality Association
CCR	California Code of Regulations

*Section 7  
Glossary and List of Acronyms*

CCS	Cellular Confinement System
CEQA	California Environmental Quality Act
CERCLA	Comprehensive Environmental Response Compensation and Liability Act
CFR	Code of Federal Register
CMA	Congestion Management Program
COE	U.S. Army Corps of Engineers
CPI	Coalescing Plate Interceptor
CWA	Clean Water Act (Federal Water Pollution Control Act of 1972 as amended in 1987)
DCIA	Directly Connected Impervious Area
DTSC	California Department of Toxic Substances Control
EEC	Effect Effluent Concentration
EIR	Environmental Impact Report
EMC	Event Mean Concentration
EOS	Equivalent Opening Size
ESA	Environmentally Sensitive Area
ESC	Erosion and Sedimentation Control
FEMA	Federal Emergency Management Agency
FHWA	Federal Highway Administration
GIS	Geographical Information System
Hazmat	Hazardous Material
HSG	Hydrologic Soil Groups
IPM	Integrated Pest Management
JURMP	Jurisdictional Urban Runoff Management Program
MEP	Maximum Extent Practicable

<b>MS4</b>	<b>Municipal Separate Storm Sewer System</b>
<b>MSDS</b>	<b>Material Safety Data Sheet</b>
<b>MSHA</b>	<b>Mine Safety and Health Administration</b>
<b>NMFS</b>	<b>National Marine Fisheries Service</b>
<b>NOAA</b>	<b>National Oceanographic and Atmospheric Administration</b>
<b>NOI</b>	<b>Notice of Intent</b>
<b>NPDES</b>	<b>National Pollution Discharge Elimination System</b>
<b>NPS</b>	<b>Nonpoint Source</b>
<b>NRC</b>	<b>National Response Center</b>
<b>NRCS</b>	<b>Natural Resources Conservation Service</b>
<b>NSF</b>	<b>National Science Foundation</b>
<b>NURP</b>	<b>National Urban Runoff Program</b>
<b>O&amp;G</b>	<b>Oil and Grease</b>
<b>O&amp;M</b>	<b>Operations and Maintenance</b>
<b>OSDS</b>	<b>On-site Disposal System</b>
<b>OSHA</b>	<b>Occupational Safety and Health Administration</b>
<b>P2</b>	<b>Pollution Prevention</b>
<b>PAHs</b>	<b>Polyaromatic Hydrocarbons</b>
<b>PAM</b>	<b>Polyacrylamide</b>
<b>PCBs</b>	<b>Polychlorinated Biphenyls</b>
<b>PCC</b>	<b>Portland Concrete Cement</b>
<b>PPT</b>	<b>Pollution Prevention Team</b>
<b>POTW</b>	<b>Publicly Owned Treatment Works</b>
<b>PSD</b>	<b>Particle Size Distribution</b>
<b>RCRA</b>	<b>Resource Conservation and Recovery Act</b>

*Section 7  
Glossary and List of Acronyms*

<b>RWQCB</b>	<b>Regional Water Quality Control Board</b>
<b>SAP</b>	<b>Sampling and Analysis Plan</b>
<b>SARA</b>	<b>Superfund Amendments and Reauthorization Act</b>
<b>SIC</b>	<b>Standard Industrial Classification</b>
<b>SPCC</b>	<b>Spill Prevention Control and Countermeasure</b>
<b>SUSMP</b>	<b>Standard Urban Stormwater Mitigation Plan</b>
<b>SWMP</b>	<b>Stormwater Management Program</b>
<b>SWPCP</b>	<b>Stormwater Pollution Control Plan</b>
<b>SWPPP</b>	<b>Stormwater Pollution Prevention Plan</b>
<b>SWRCB</b>	<b>State Water Resource Control Board</b>
<b>TMDL</b>	<b>Total Maximum Daily Load</b>
<b>TOC</b>	<b>Total Organic Carbon</b>
<b>TSS</b>	<b>Total Suspended Solids</b>
<b>UFC</b>	<b>Uniform Fire Code</b>
<b>USACE</b>	<b>United States Army Corps of Engineers</b>
<b>USDA</b>	<b>United States Department of Agriculture</b>
<b>USDOT</b>	<b>United States Department of Transportation</b>
<b>USEPA</b>	<b>United States Environmental Protection Agency</b>
<b>WEF</b>	<b>Water Environment Federation</b>

**Appendix A**  
**Channel Impacts from Watershed Changes**





# Appendix A

## Channel Impacts from Watershed Changes

Channels are formed, maintained, and altered by the water and sediment they carry.

Channel equilibrium involves the interplay of four basic factors:

- Sediment discharge ( $Q_s$ )
- Sediment particle size ( $D_{50}$ )
- Streamflow ( $Q_w$ )
- Stream slope ( $S$ )

Lane (1955) showed this relationship qualitatively as:

$$Q_s \cdot D_{50} \propto Q_w \cdot S$$

This equation is shown here as a balance with sediment load on one weighing pan and streamflow on the other.

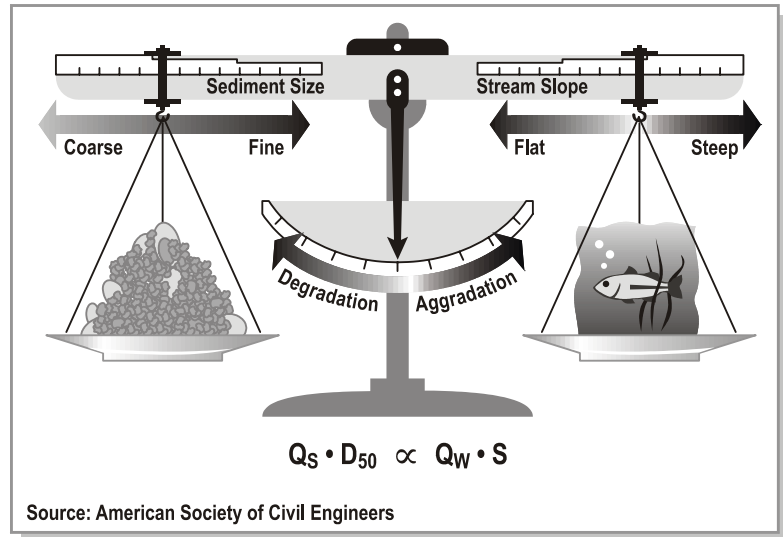

The hook holding the sediment pan can slide along the horizontal arm to adjust according to sediment size. The hook holding the streamflow side can adjust according to stream slope.

Channel equilibrium occurs when all four variables are in balance. If a change occurs, the balance will temporarily be tipped and equilibrium lost. If one variable changes, one or more of the other variables must increase or decrease proportionally if equilibrium is to be maintained. For example, if channel slope is increased (e.g., by channel straightening) and streamflow remains the same, either the sediment load or the size of the particles must also increase. Likewise, if flow is increased (e.g., by an inter-basin transfer) and the slope stays the same, sediment load or sediment particle size has to increase to maintain channel equilibrium. Under these examples' conditions, a stream seeking a new equilibrium will tend to erode more of its banks and bed, transporting larger particle sizes and a greater sediment load.

Alluvial streams that are free to adjust to changes in these four variables generally do so and re-establish new equilibrium conditions. Non-alluvial streams such as bedrock or artificial, concrete channels are unable to follow Lane's relationship because of their inability to adjust the sediment size and quantity variables.

The stream balance equation is useful for making qualitative predictions concerning channel impacts due to changes in runoff or sediment loads from the watershed. Quantitative

predictions, however, require the use of more complex equations. Sediment transport equations, for example, are used to compare sediment load and energy in the stream. If excess energy is left over after the load is moved, channel adjustment occurs as the stream picks up more load by eroding its banks or scouring its bed.

**Appendix B**  
**General Applicability of Effluent**  
**Probability Method**



# Appendix B

## General Applicability of Effluent Probability Method

Some researchers have experienced concerns about the general applicability of this technique and whether or not it should be considered the standard approach for quantifying BMP efficiency. To illustrate potential issues, plots have been developed for TSS from Austin style sand filters.

Figure 1 (Scale is a little unusual in that divisions are 10, 25, 50, 100, 250...) is a plot of the TSS data, which implies that one could expect an effluent concentration of about 25 mg/L, when the influent concentration is about 400 mg/L, or 1 mg/L when the influent concentration is about 25 mg/L. This would be equivalent to a constant percent removal of about 94%. This interpretation is based on the implied relationship between influent and effluent quality that the rank order of influent and effluent concentrations is highly correlated as indicated by the arrows in Figure 1. That is, the highest influent concentration is from the same event as the highest effluent concentration.

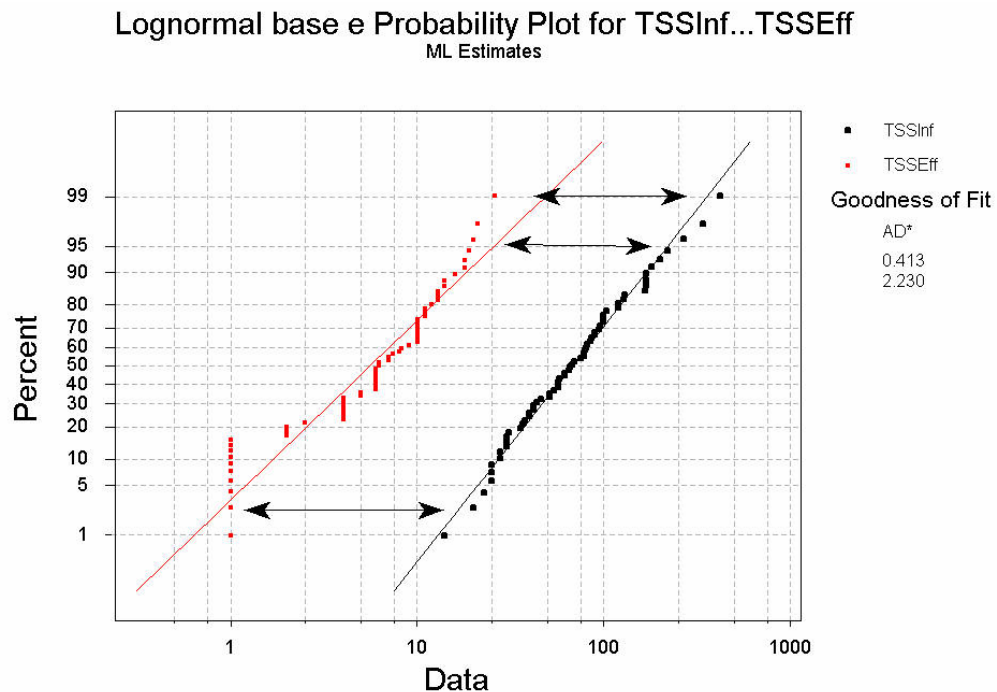

**Figure 1**  
**Implied Meaning of the Probability Plot Method**

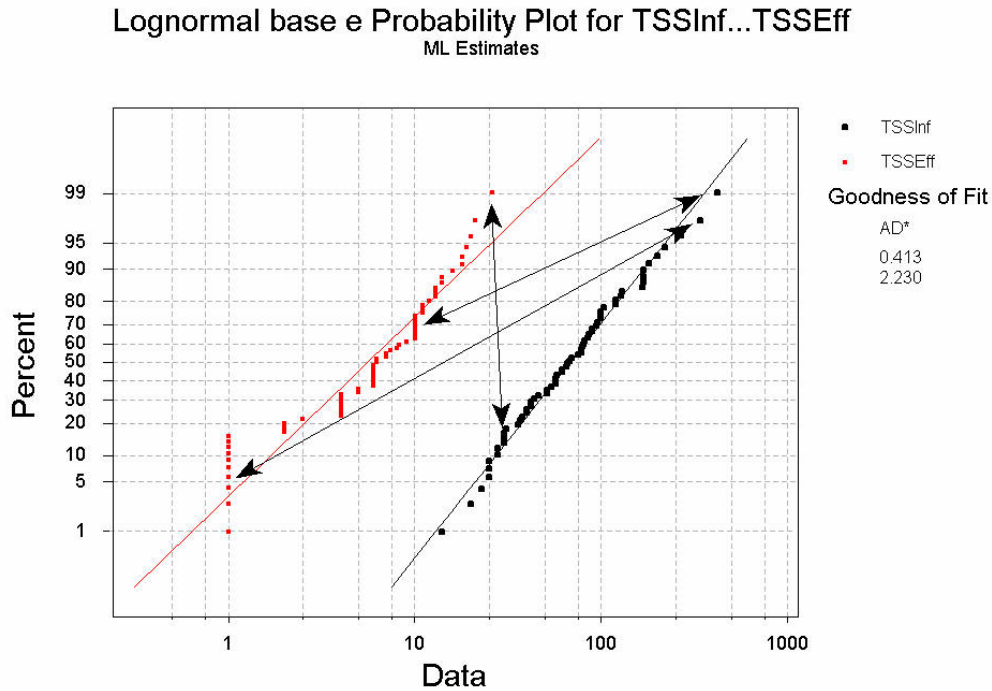

**Figure 2**  
**Probability Plot showing Actual Paired Values**

This assumption is not valid for this data set. As shown in Figure 2, the arrows connect the actual paired values, so that one can see that high influent concentrations may be associated with effluent concentrations that are at or near the lowest levels observed in the study.

The paired values are plotted in Figure 3, which indicates no statistical relationship between influent and effluent concentrations – not unusual for sand filters. This type of plot indicates much more clearly that the effluent concentration is relatively constant at about 7.5 mg/L, regardless of influent concentration. This regression on EMCs, which is similar to the ROL described in the protocol seems to meet most of the requirements for linear regression, concerning residuals, etc., and better defines the expected behavior. It may be more suitable to perform the regression on concentrations, since the impact of amount of infiltration, which is a function of storm volume and antecedent moisture conditions is eliminated. In the past, the rejection of regression as a potential methodology was based on the results of single study, rather than widespread application on a number of technologies and sites. In this example, regression has been applied to a number of Caltrans BMP technologies and sites. An example where influent and effluent concentrations are correlated is shown in Figure 4 for TKN (with 90% confidence interval for mean and individual predictions).

(Note: 95% statistical certainty is a common threshold in studies to determine significance; however, because of the high variability in stormwater and the paucity of data, a 90% confidence interval has been used. It may be appropriate to raise that level as more data become available for analysis.)

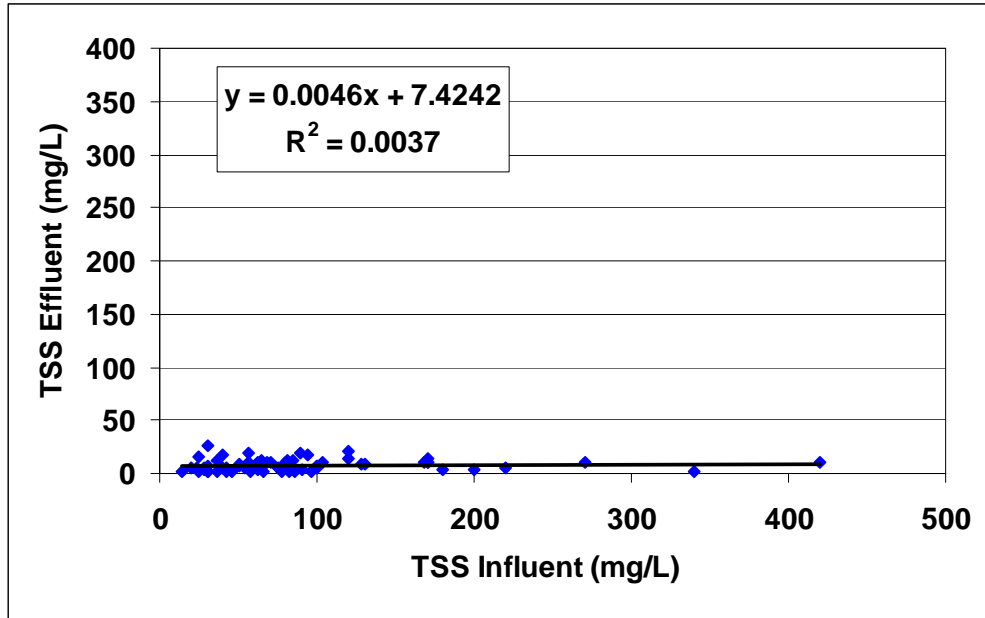

Figure 3  
Relationship between Influent and Effluent TSS Concentrations

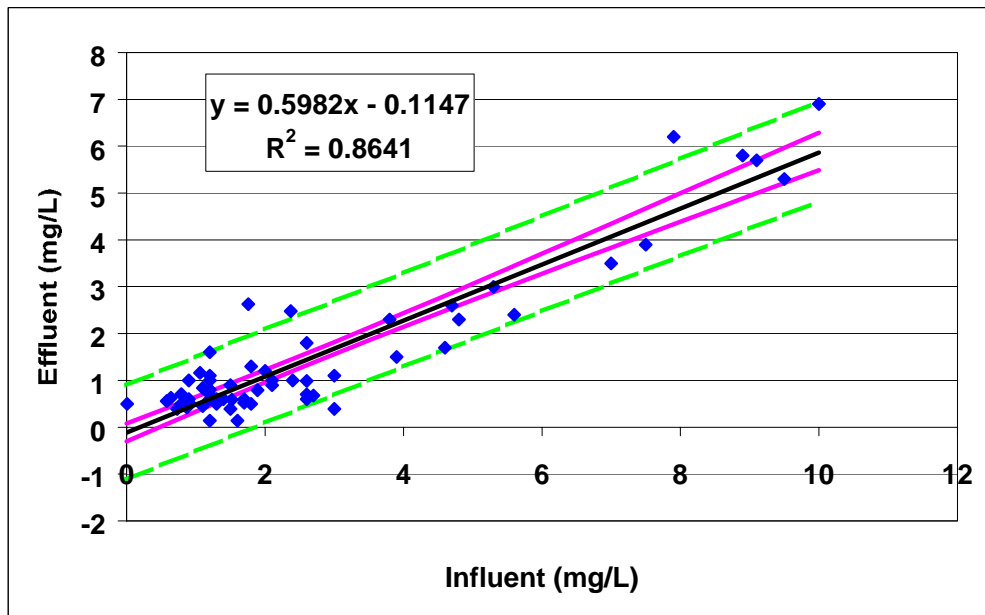

Figure 4  
Relationship between Influent and Effluent TKN Concentrations

Another concern is that the effluent probability plot alone does not necessarily provide sufficient information for BMP selection. In Texas and other areas, there are regulations that require removal of 80% of the TSS resulting from development. Using the effluent probability plot alone, it may be difficult to see how one would determine if a BMP was capable of meeting this standard or other performance standard.





**Appendix C**  
**Comparison of Effluent Concentrations**  
**of Additional Metals**



# Appendix C

## Comparison of Effluent Concentrations of Additional Metals

Graphs comparing effluent concentrations produced by several types of treatment BMPs for TSS, Nitrogen, Zinc, and Fecal Coliform, are included in 5.3.1. Graphs for other metals and phosphorus are provided below.

Appendix C  
 Comparison of Effluent Concentrations of Additional Metals

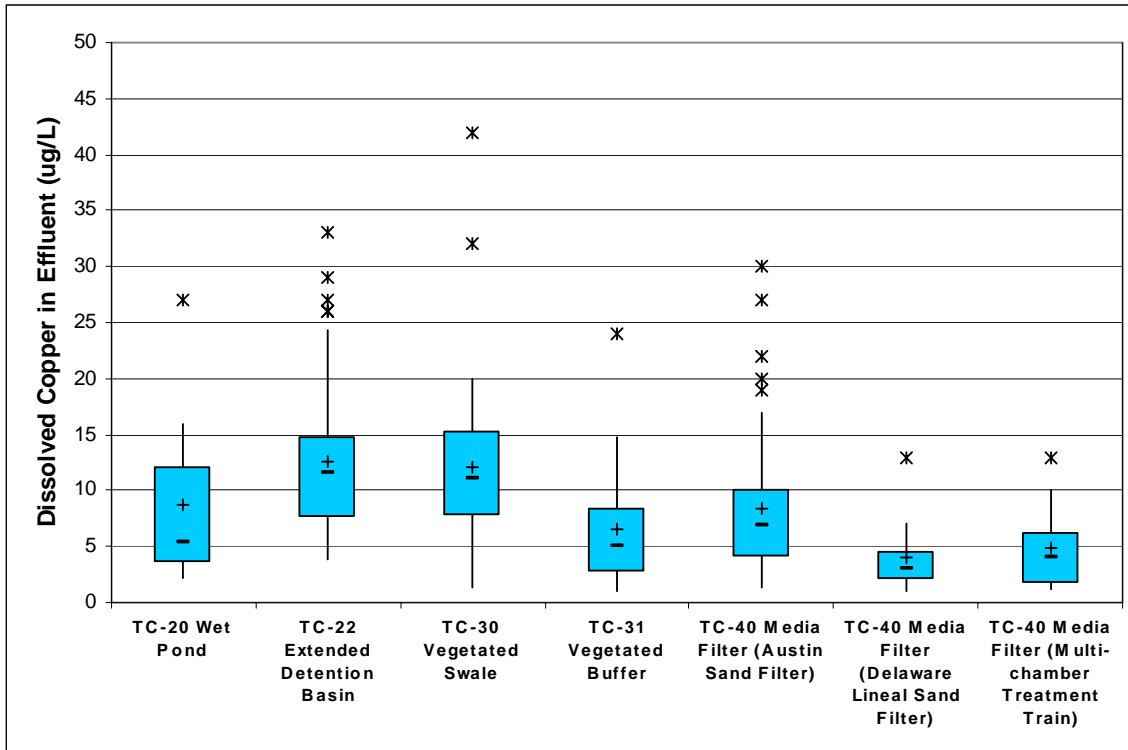

Dissolved Copper in Effluent

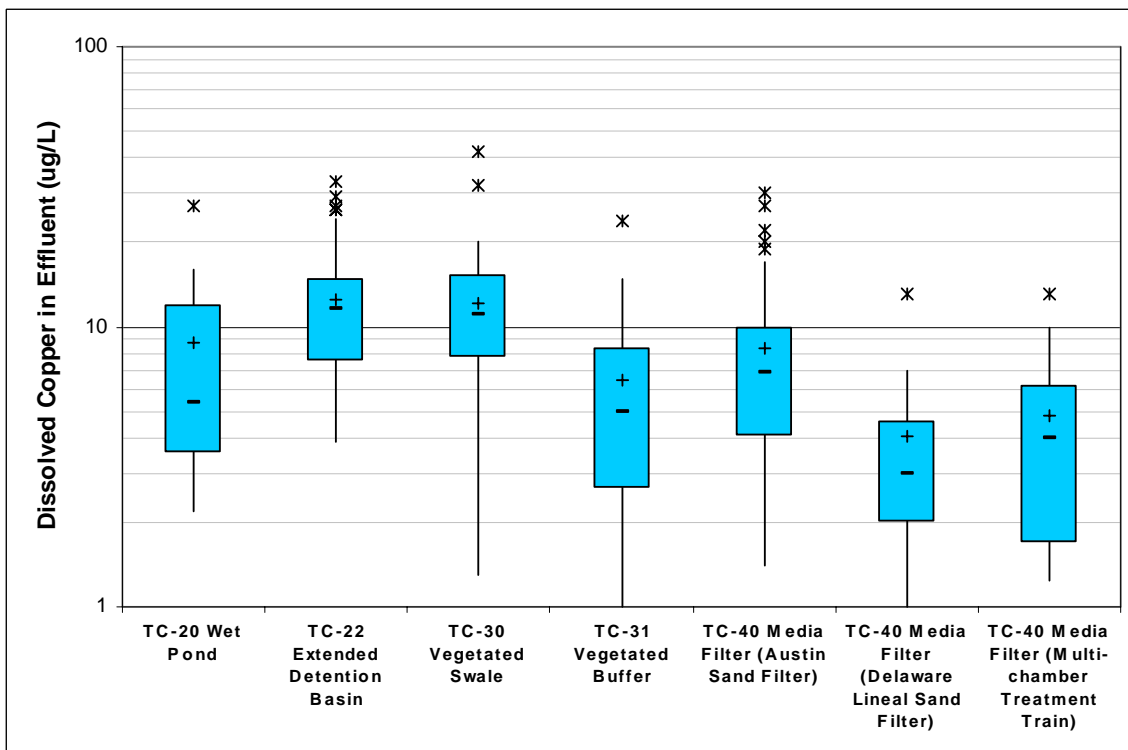

Dissolved Copper in Effluent (log format)

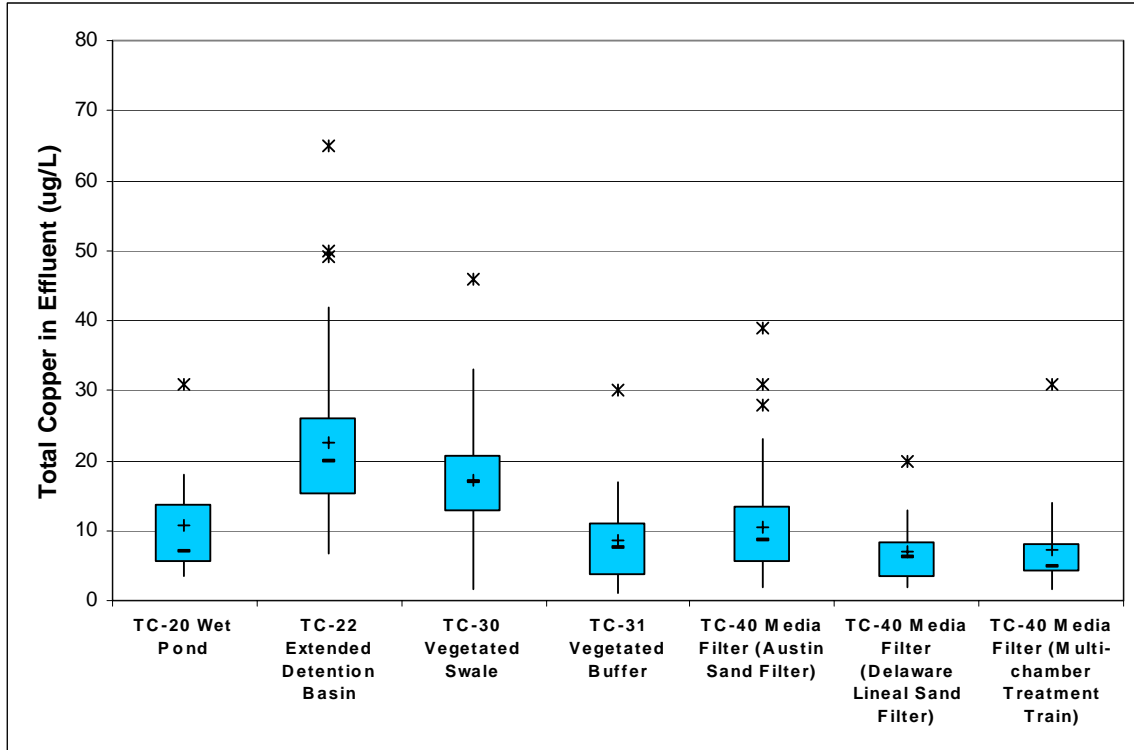

Total Copper in Effluent

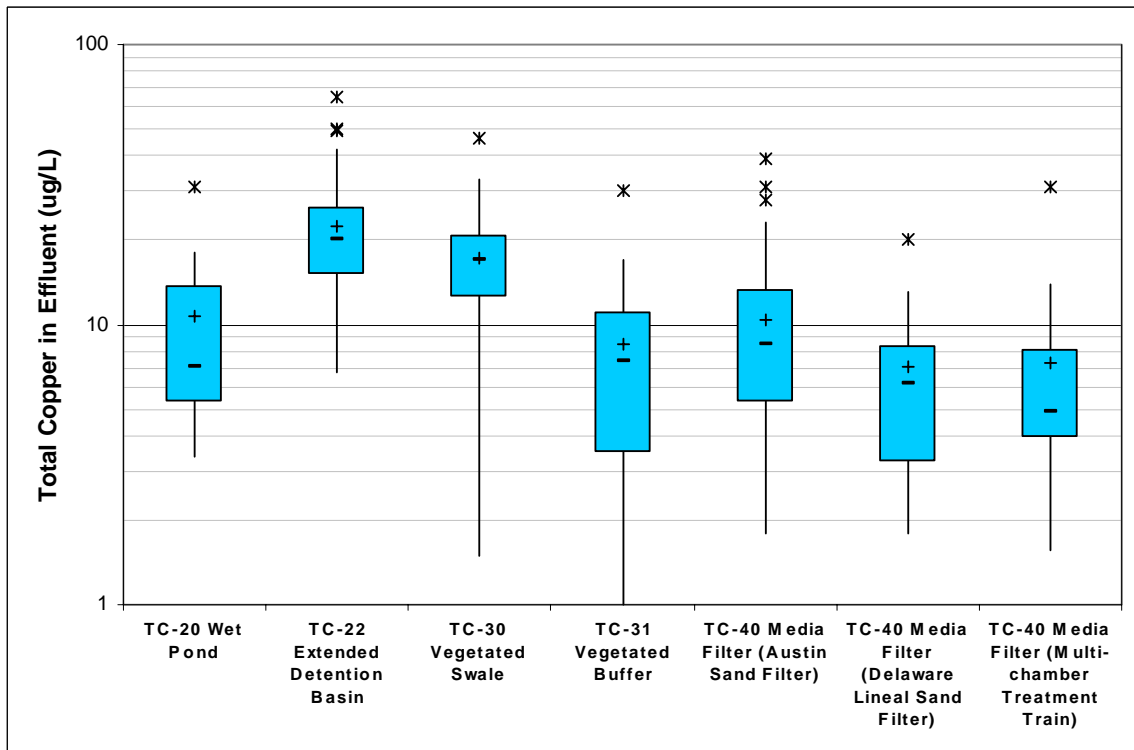

Total Copper in Effluent (log format)

Appendix C  
 Comparison of Effluent Concentrations of Additional Metals

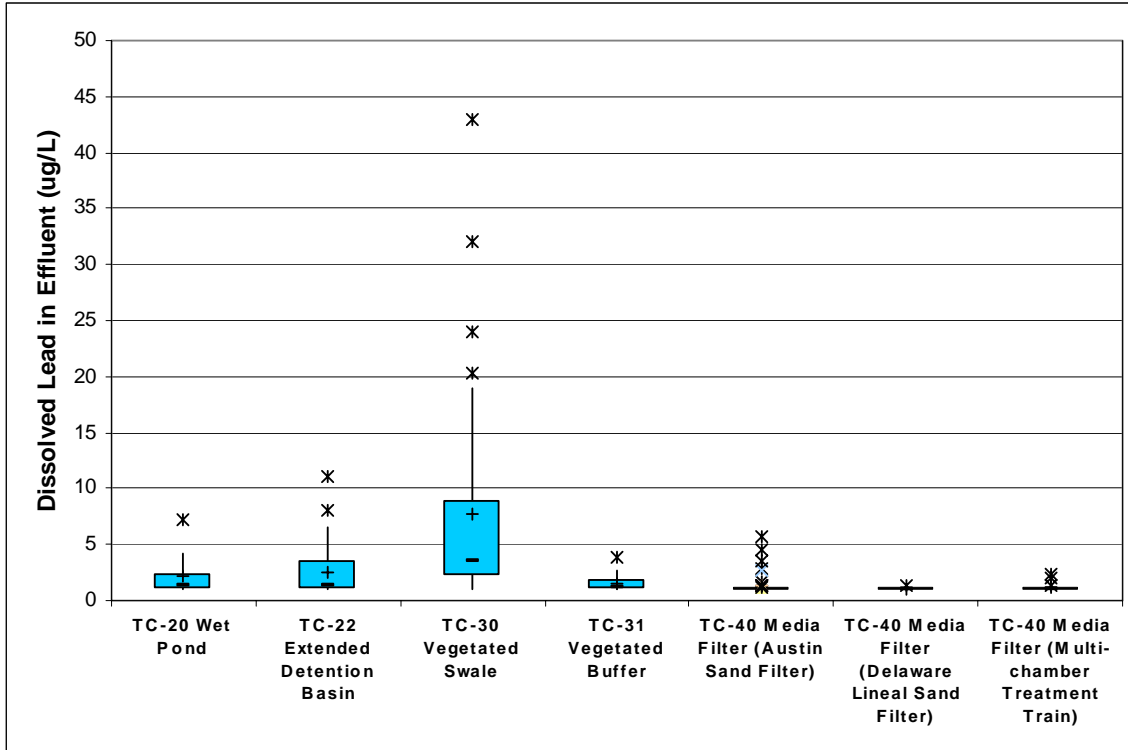

Dissolved Lead in Effluent

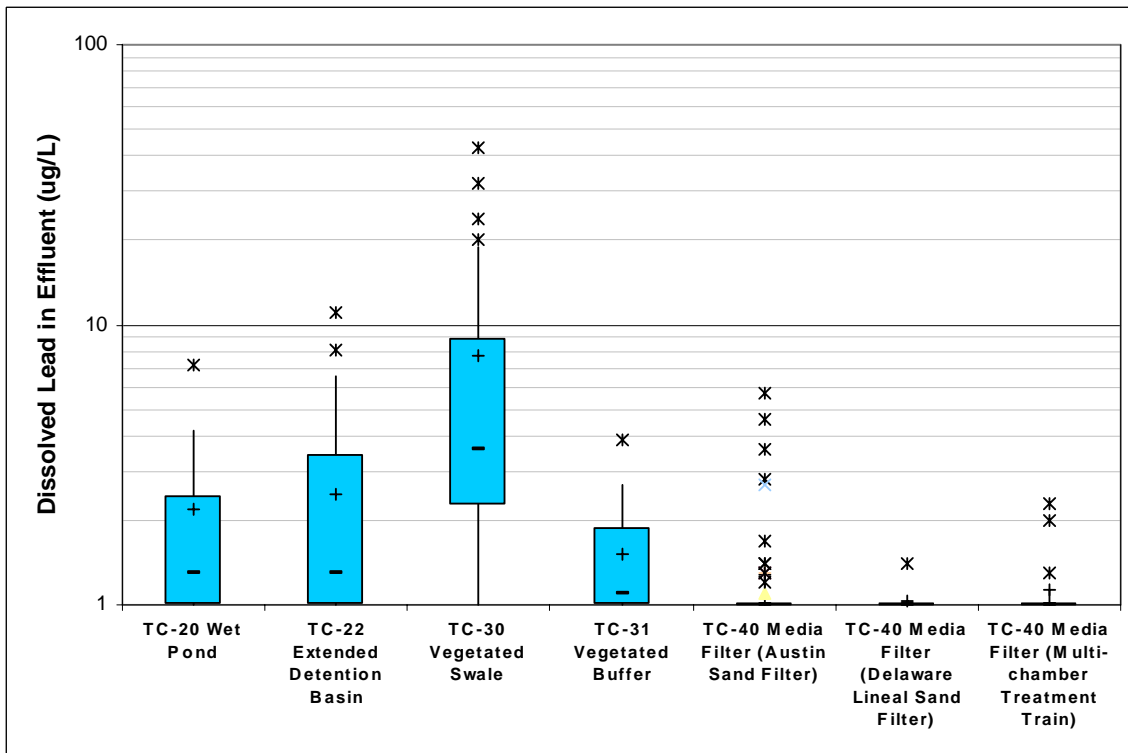

Dissolved Lead in Effluent (log format)

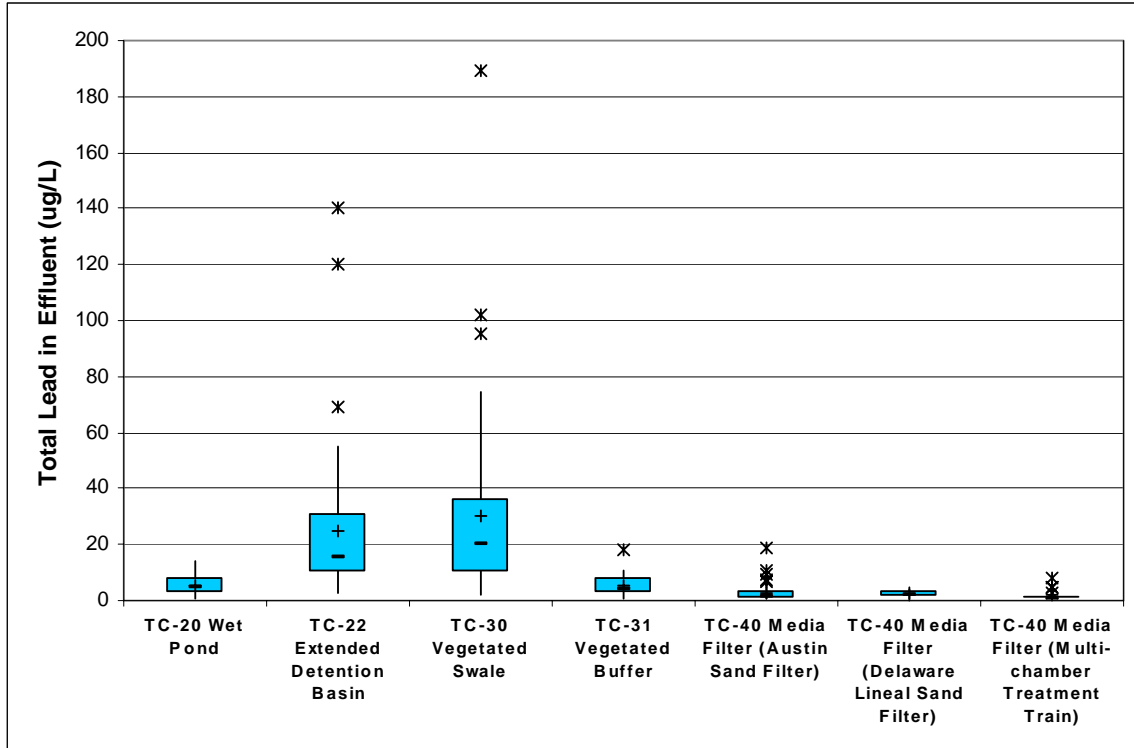

Total Lead in Effluent

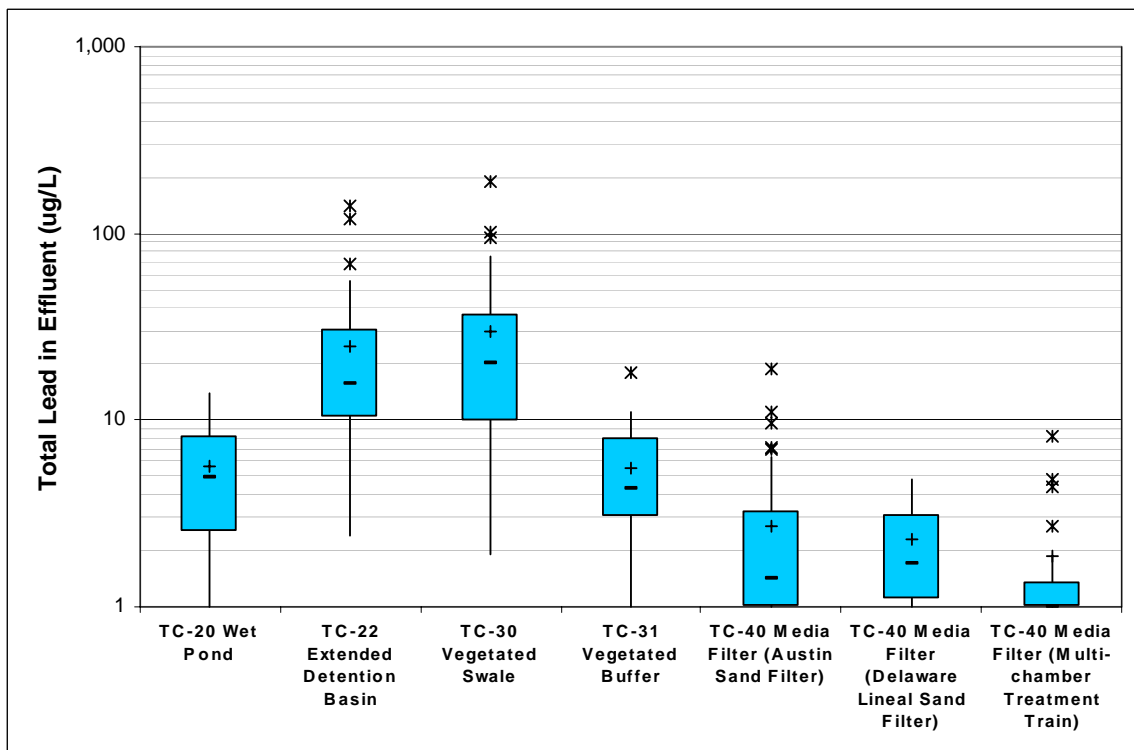

Total Lead in Effluent (log format)

Appendix C  
 Comparison of Effluent Concentrations of Additional Metals

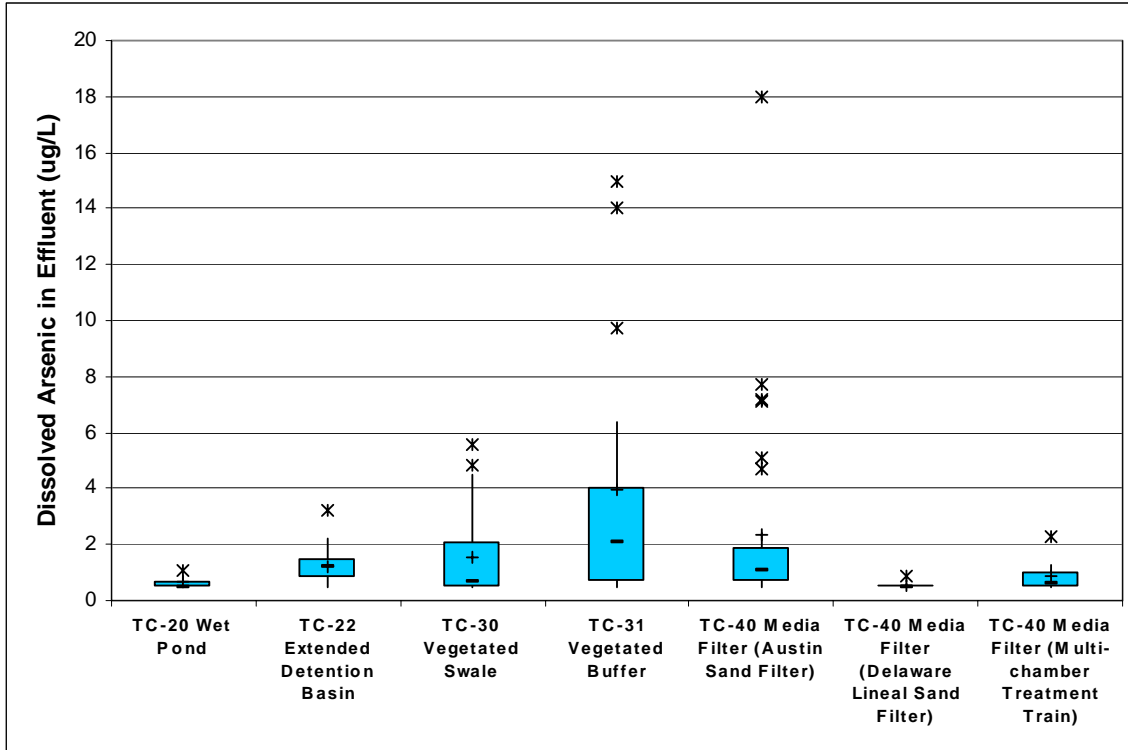

Dissolved Arsenic in Effluent

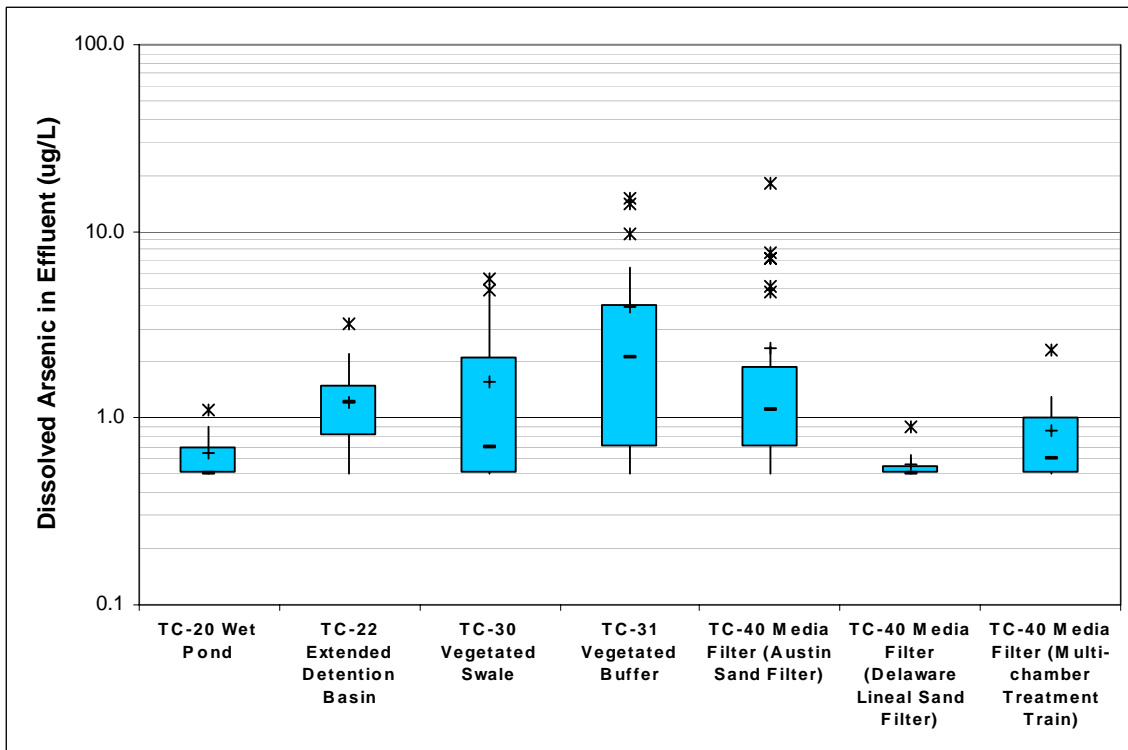

Dissolved Arsenic in Effluent (log format)



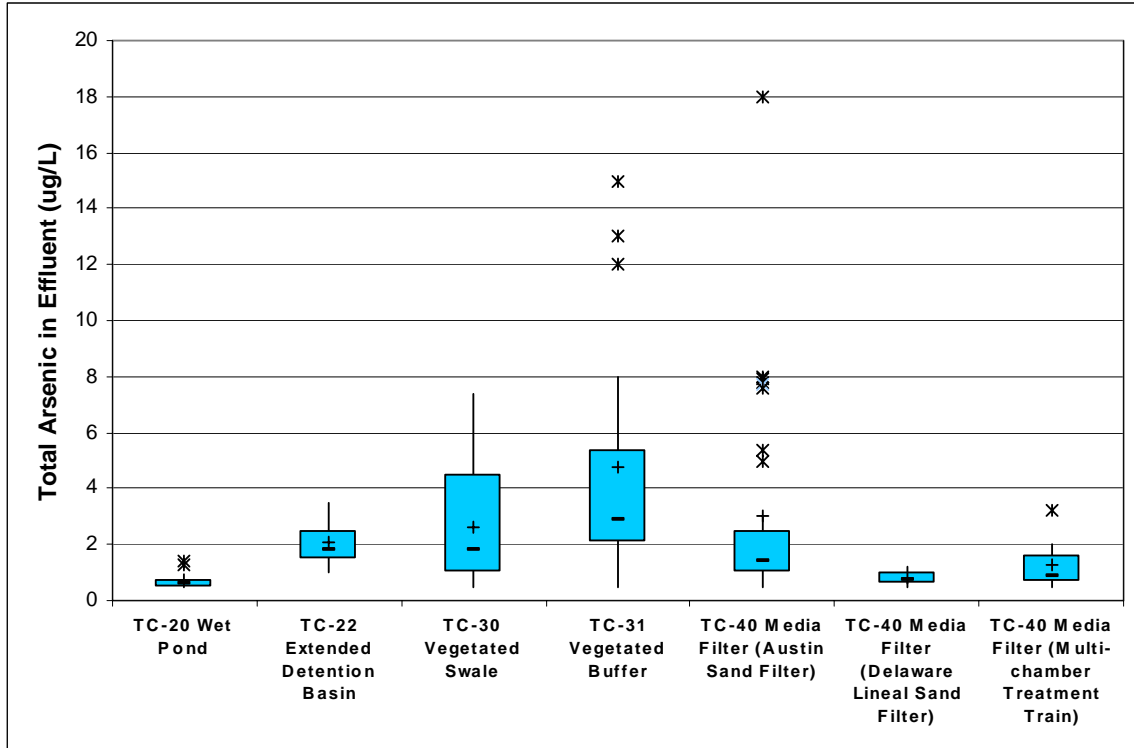

Total Arsenic in Effluent

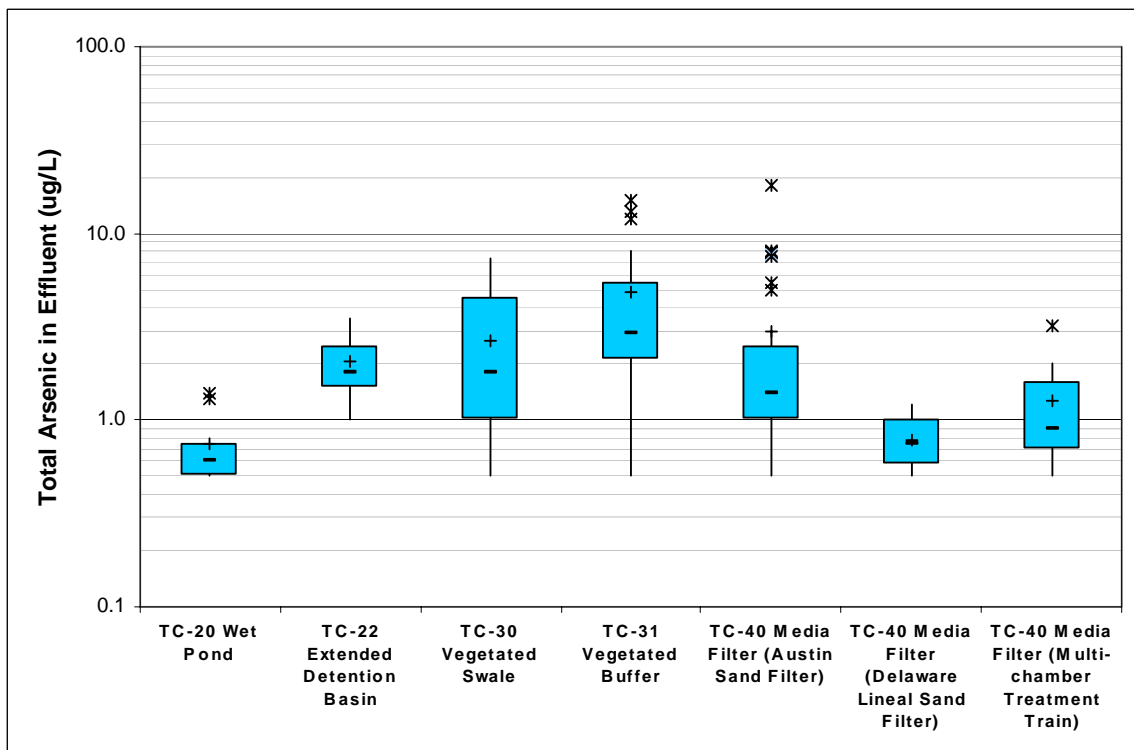

Total Arsenic in Effluent (log format)

Appendix C  
 Comparison of Effluent Concentrations of Additional Metals

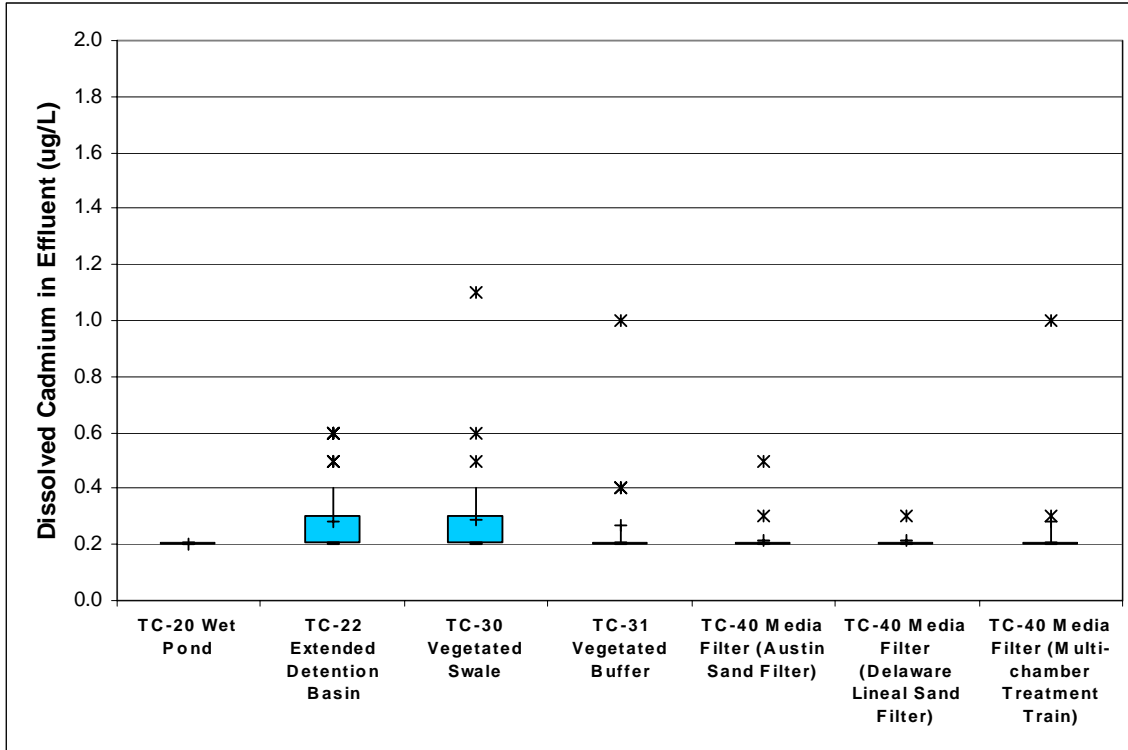

Dissolved Cadmium in Effluent

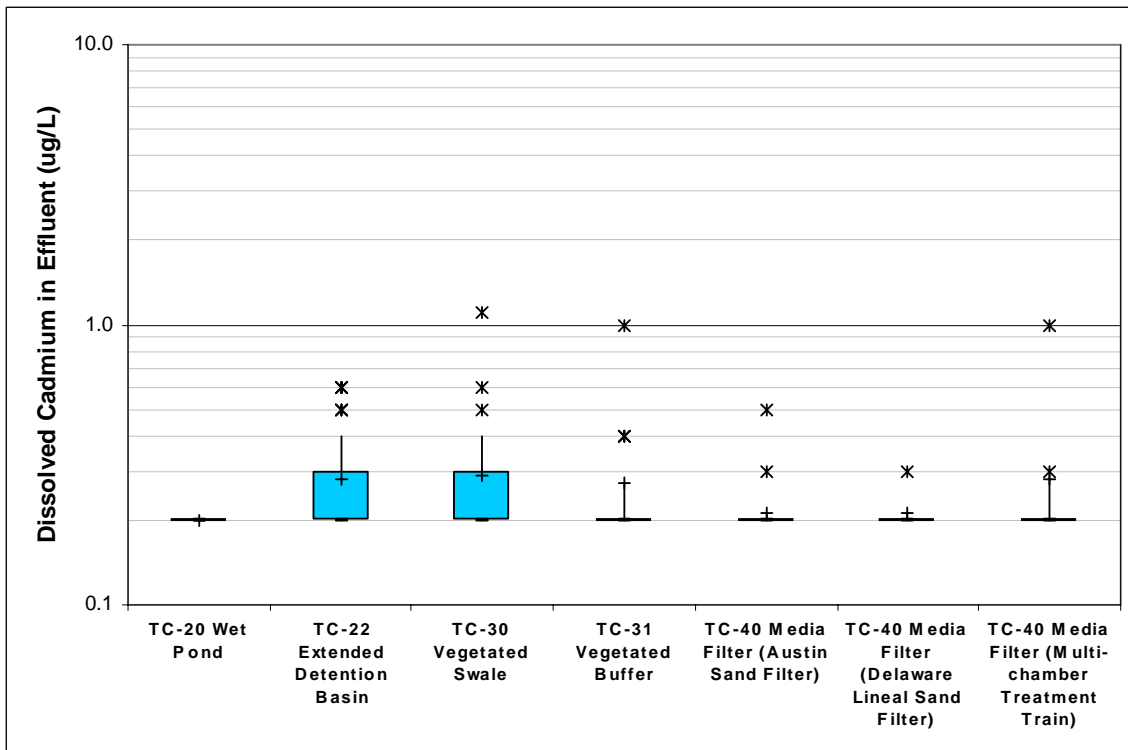

Dissolved Cadmium in Effluent (log format)

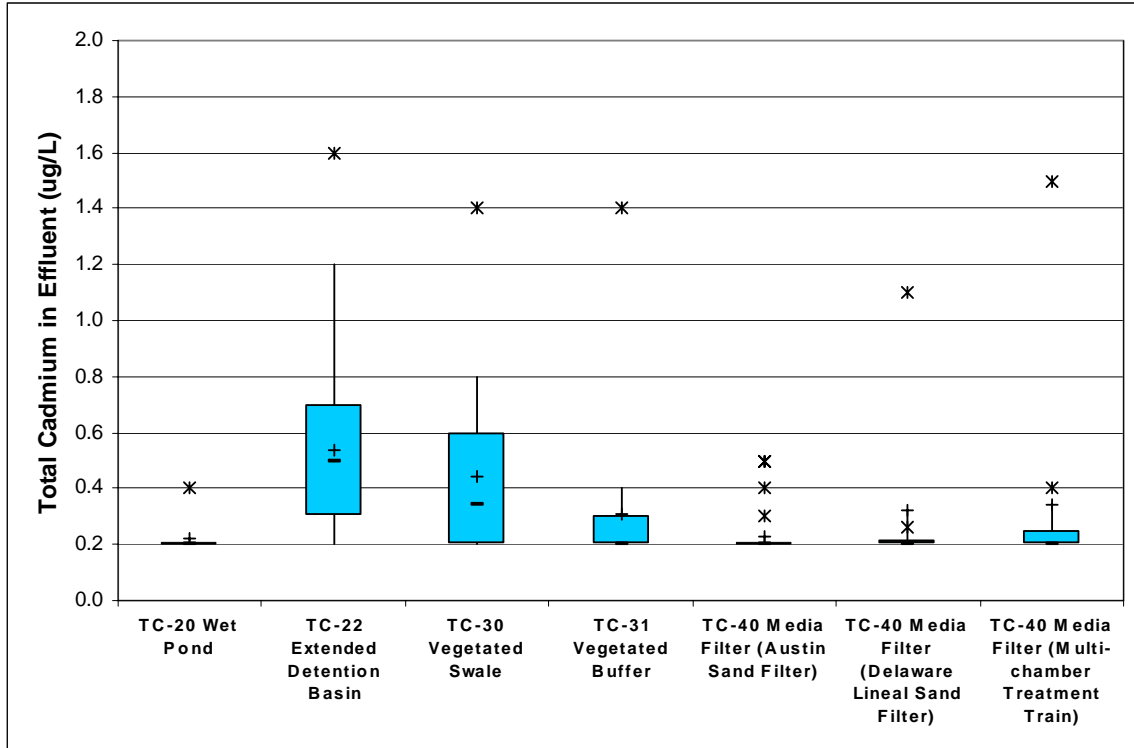

Total Cadmium in Effluent

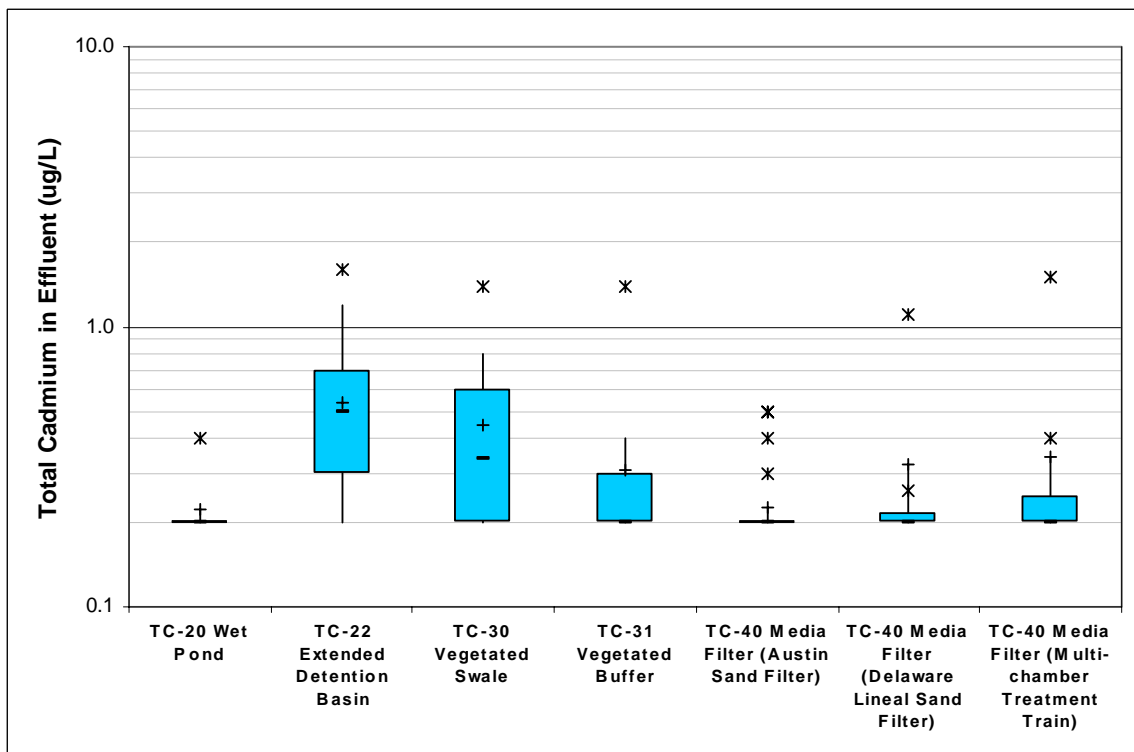

Total Cadmium in Effluent (log format)

Appendix C  
 Comparison of Effluent Concentrations of Additional Metals

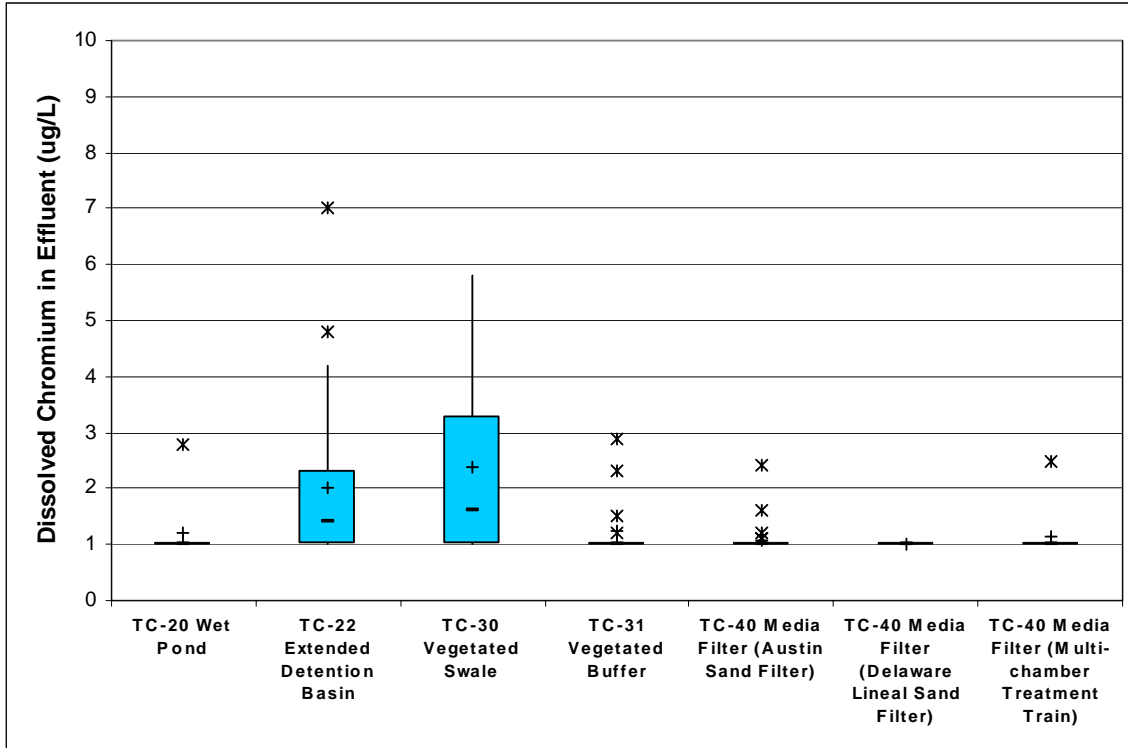

Dissolved Chromium in Effluent

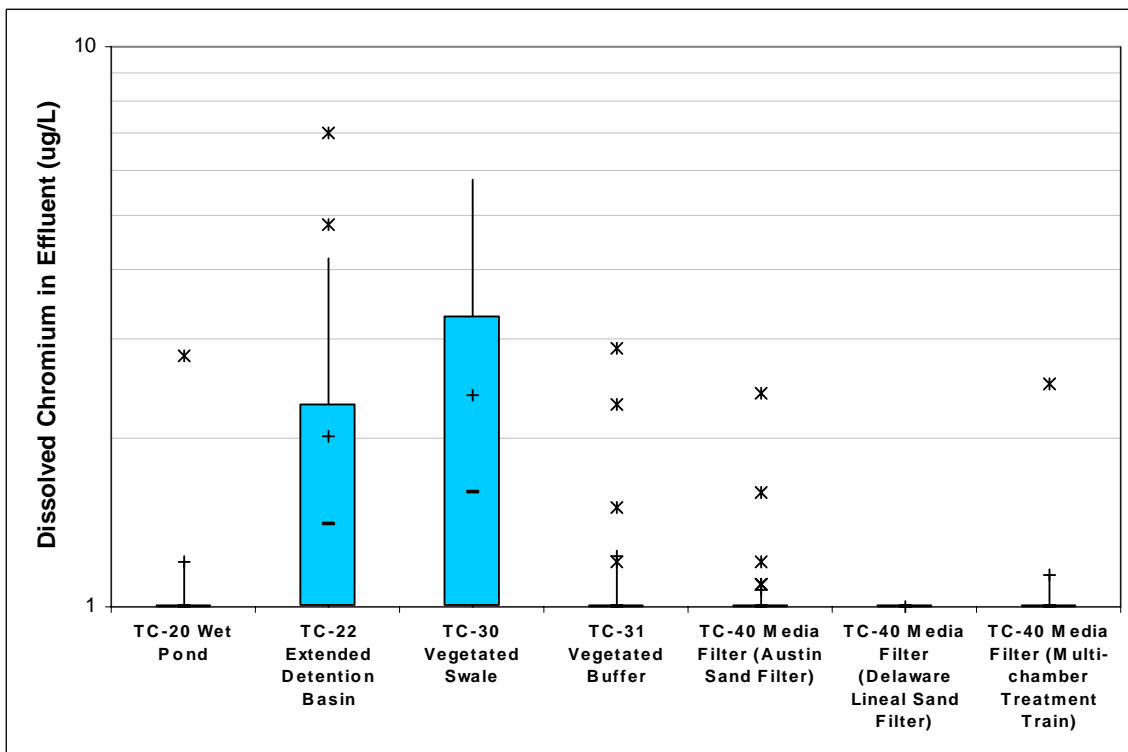

Dissolved Chromium in Effluent (log format)

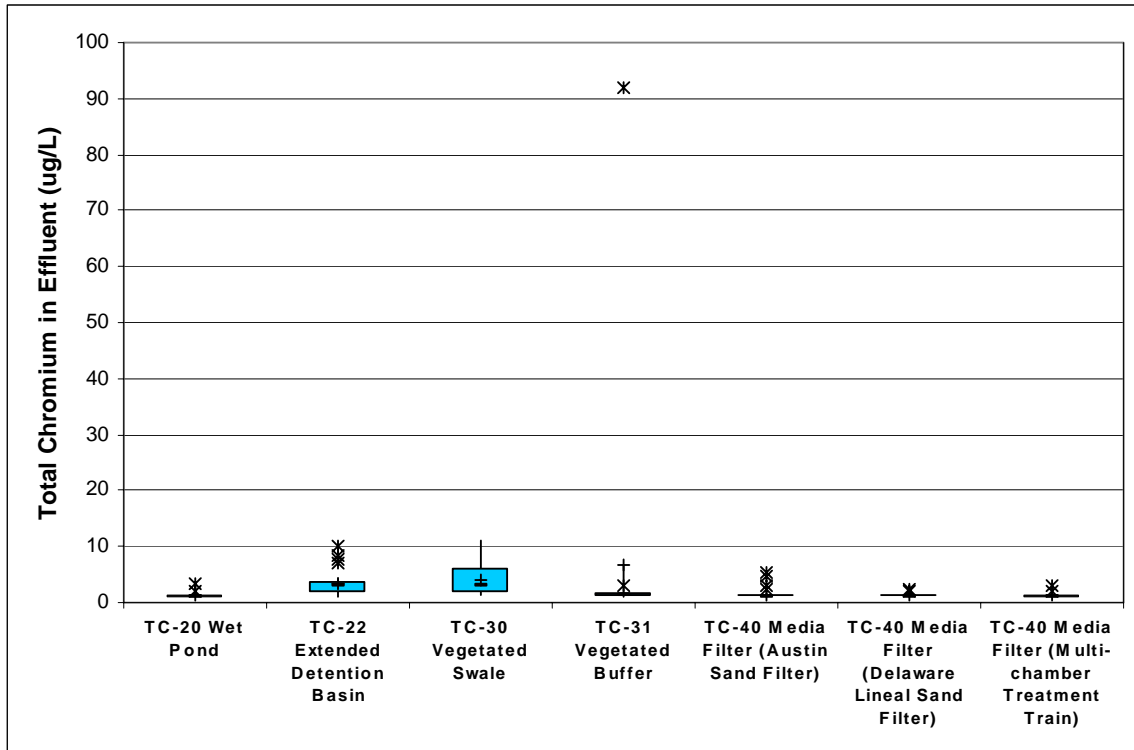

Total Chromium in Effluent

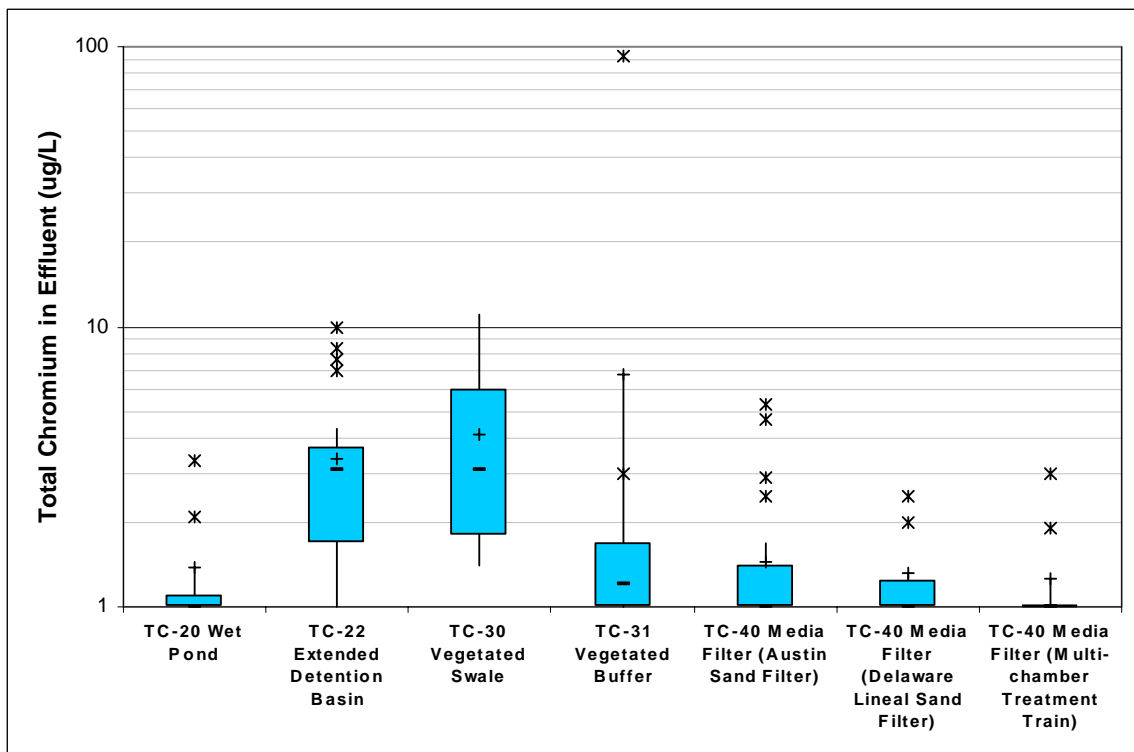

Total Chromium in Effluent (log format)

Appendix C  
 Comparison of Effluent Concentrations of Additional Metals

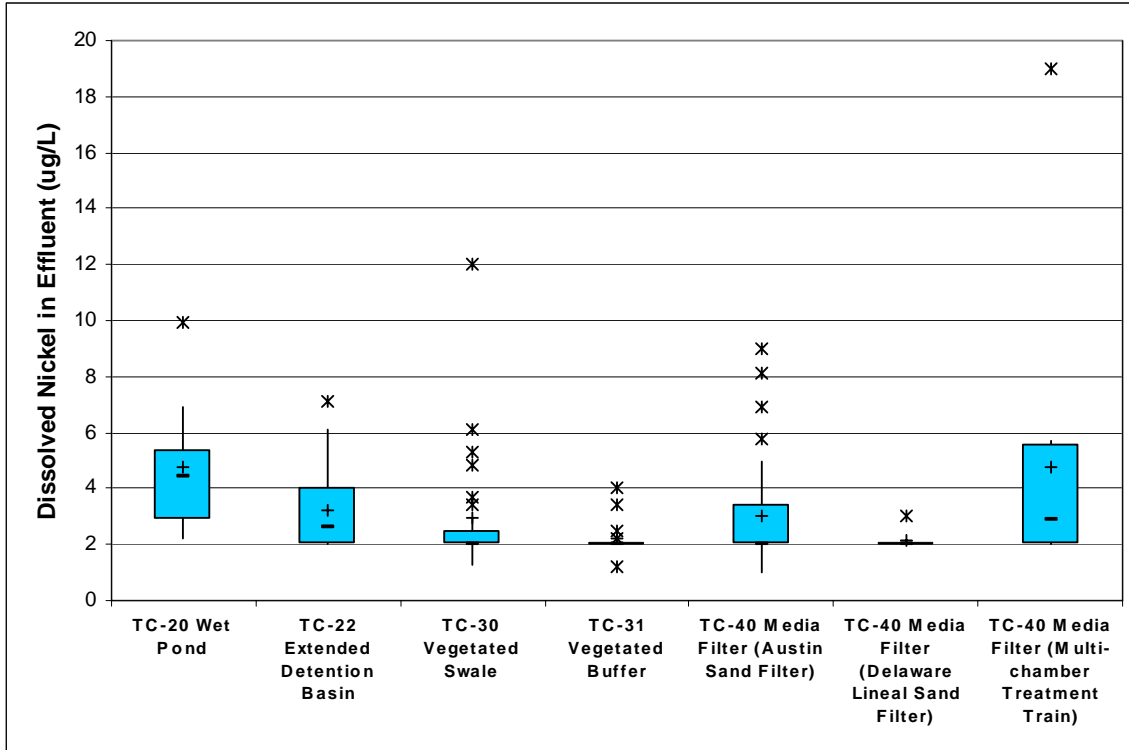

Dissolved Nickel in Effluent

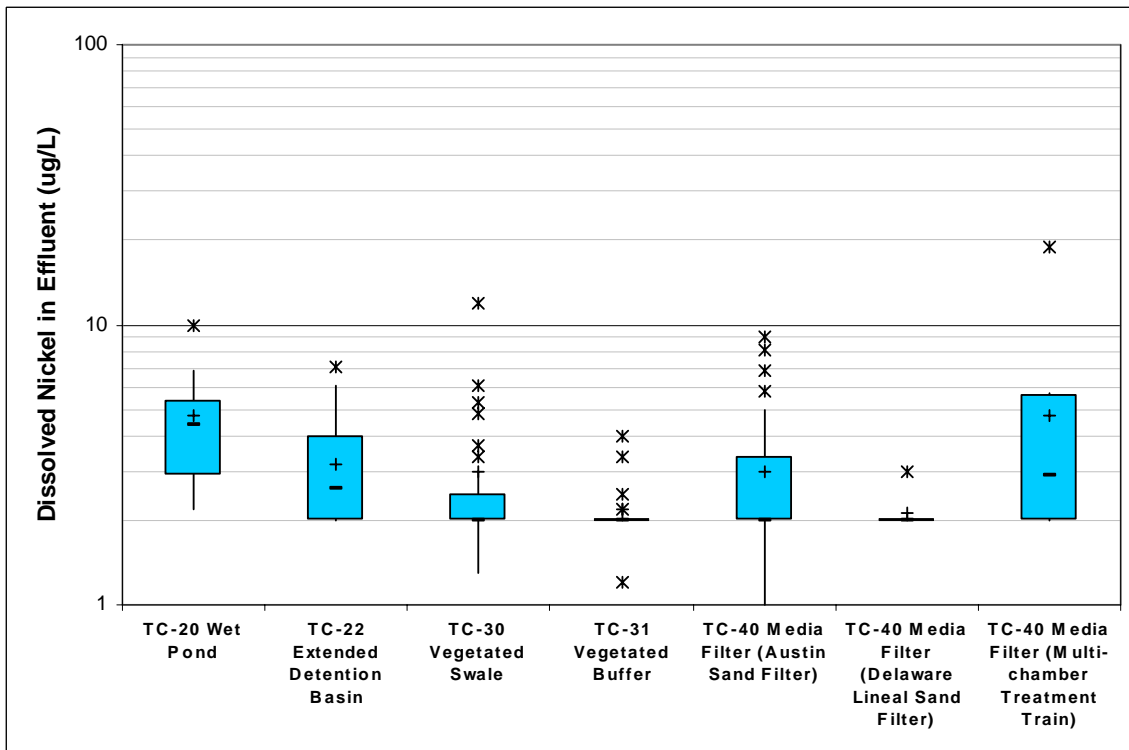

Dissolved Nickel in Effluent (log format)

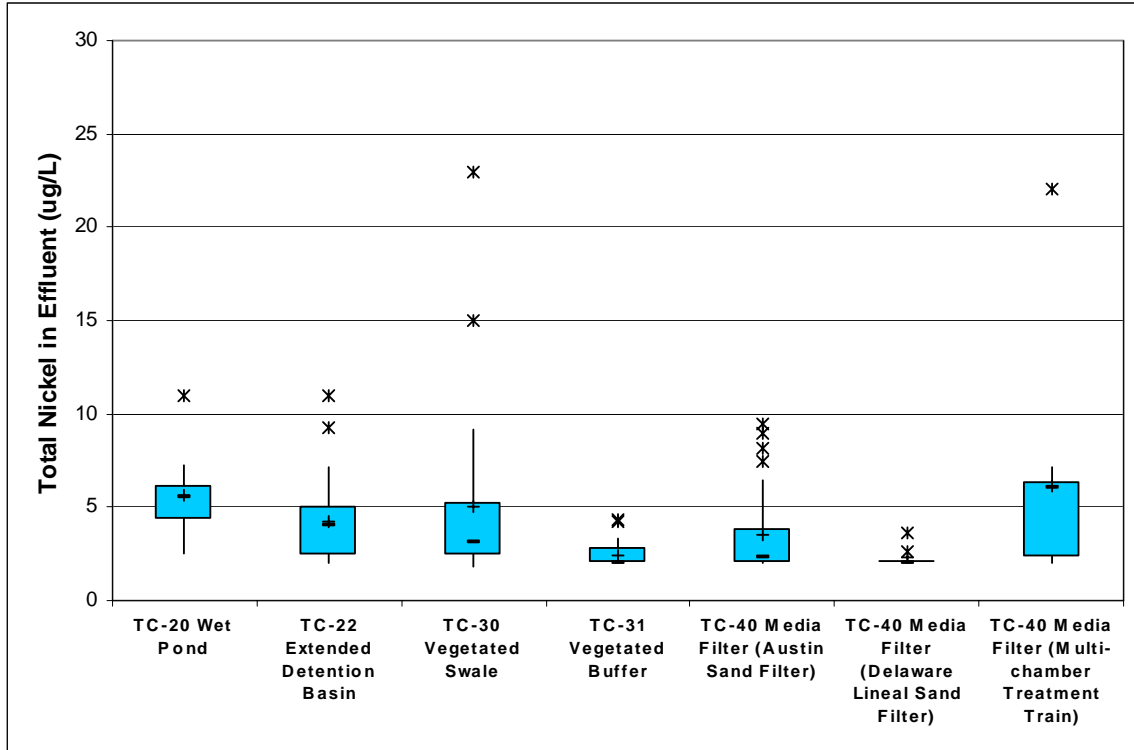

Total Nickel in Effluent

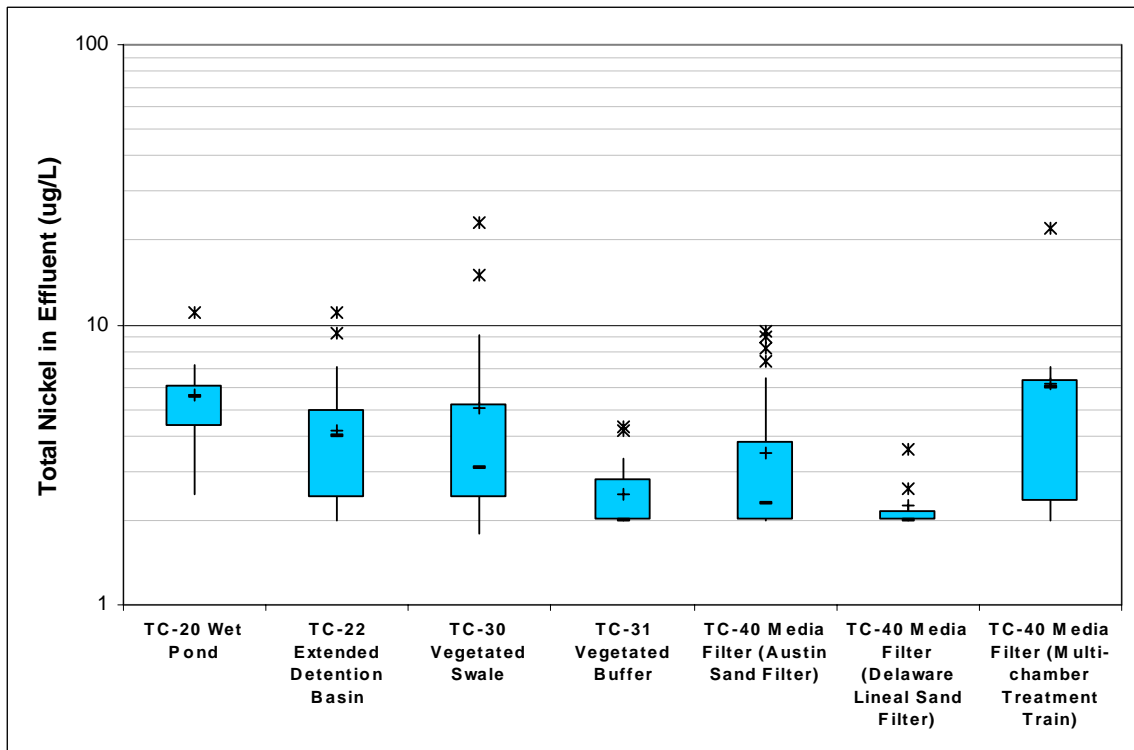

Total Nickel in Effluent (log format)

Appendix C  
 Comparison of Effluent Concentrations of Additional Metals

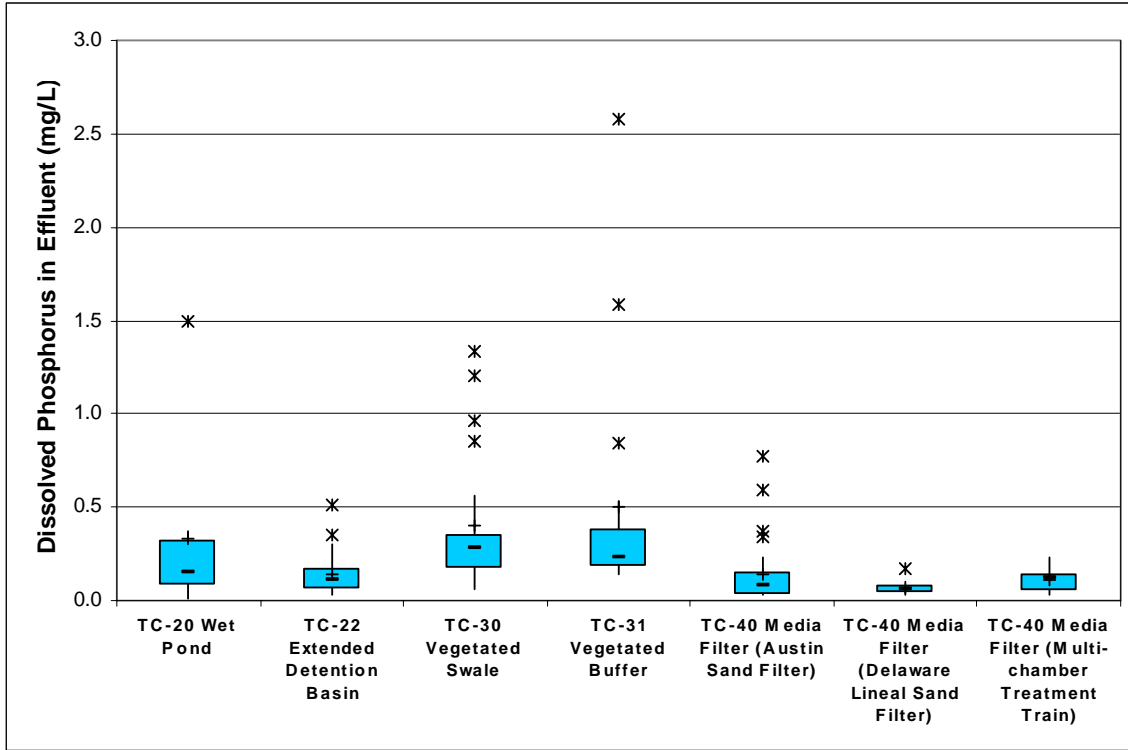

Dissolved Phosphorus in Effluent

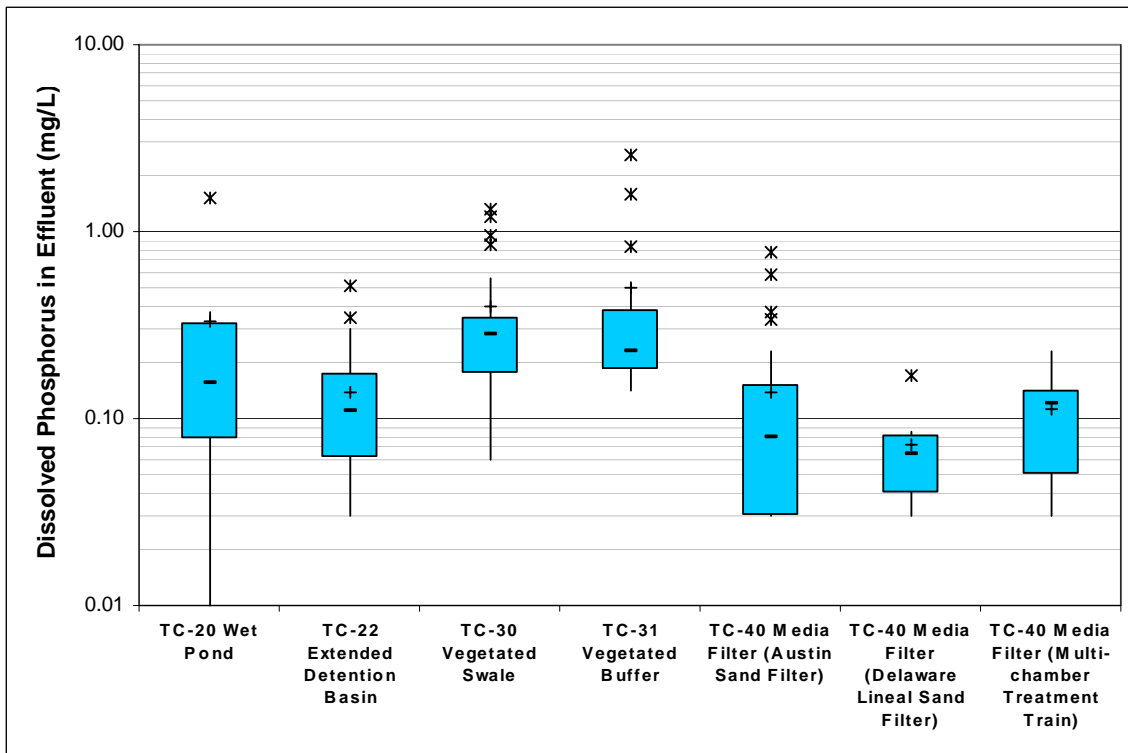

Dissolved Phosphorus in Effluent (log format)



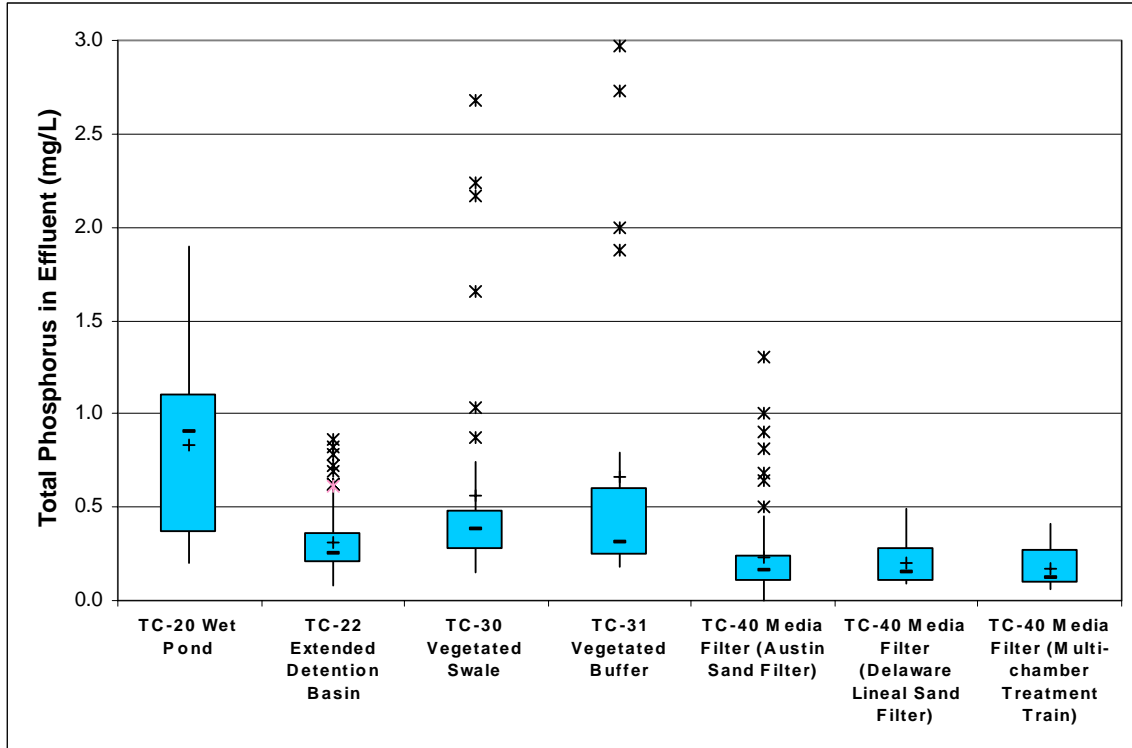

Total Phosphorus in Effluent

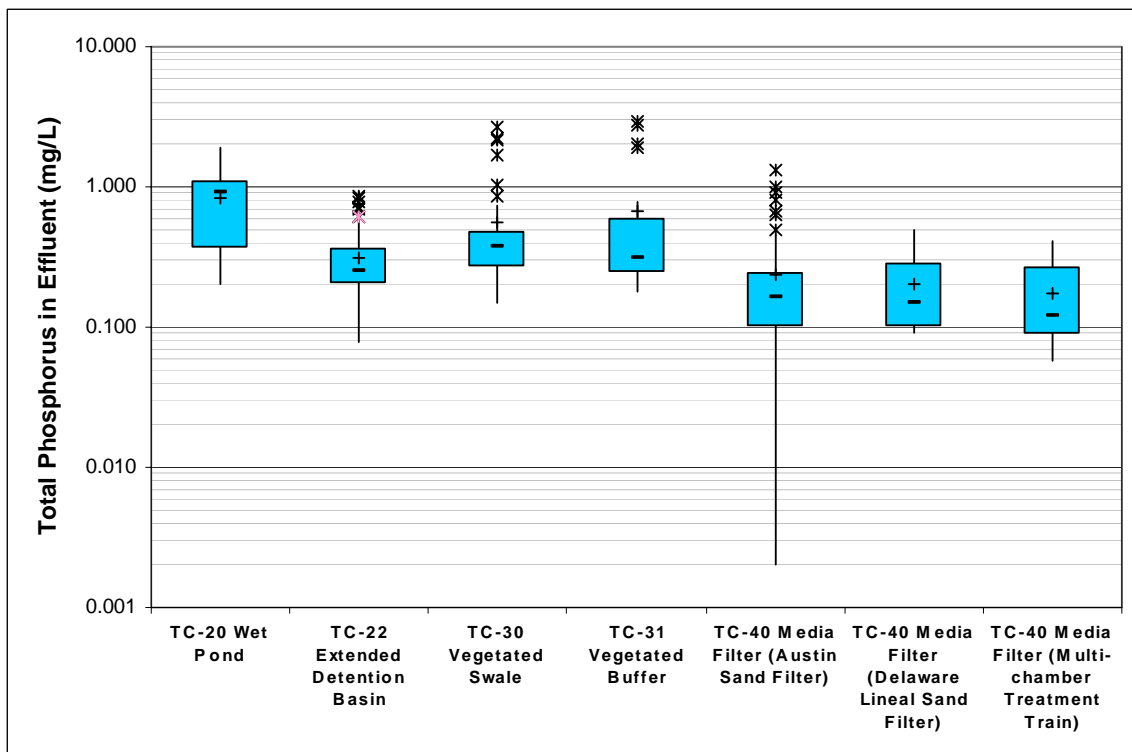

Total Phosphorus in Effluent (log format)



**Appendix D**  
**Selected Rain Gauge Index**

# Appendix D

## Selected Rain Gauge Index

This appendix contains hydrologic data needed for BMP design in accordance with volume-based and flow-based BMP design criteria included in many MS4 permits. For information on volume-based and flow-based BMP design criteria, refer to Section 5.5 of this handbook.

This appendix contains the following information.

## Rain Gauge Index Map

The rain gauge index map provides a visual index for selecting a rain gauge closest to the site where volume-based or flow-based BMP design criteria will be applied. The index map is for quick reference only: selection of a specific gauge for use in design should be based on the rain gauge data table which provides additional information about each rain gauge, such as latitude, longitude, elevation, and rainfall statistics, which should be considered when identifying a gauge most representative of the project site.

## Rain Gauge Data Table

The rain gauge data table provides important information about the rain gauges included in this appendix. Rain gauges analyzed and included in this appendix represent a wide range of municipal stormwater permit areas, climatic areas, geography, and topography across California. Using the station location, latitude, longitude, elevation, and rainfall statistics, it should be possible to identify a gauge that is sufficiently representative of most sites in California, as there is generally less variation among sites across the State when the comparisons are made based on the frequent, small storms used for BMP design as opposed to the infrequent, large storms used for flood control design.

The rain gauge data table also tabulates estimates of mean storm depths ( $P_6$ ).  $P_6$  is used for volume design using the Urban Runoff Quality Management approach discussed in Section 5.5.1 of this handbook. The values in the table were extrapolated and approximated from the map included in the document, Urban Runoff Quality Management (WEF Manual of Practice No. 23/ASCE Manual of Practice No. 87, (1998), pages 176). Urban Runoff Quality Management references the document, *Analysis of Storm Events, Characteristics for Selected Rain Gauges Throughout the United States* (Driscoll, E.D., et al., 1989, U.S. EPA) for the source information. A future addition to this handbook may be an analysis of the data set for the tabulated gauges to determine site-specific values of  $P_6$  for inclusion in this handbook.

## Analysis of Rain Gauge Data

The rain gauge data for the stations identified in the range gauge table were analyzed to determine the basin volumes required to capture various percentages of annual runoff, and to determine various percentiles of hourly rainfall intensities. The basin-volume analysis is part of the California Stormwater BMP Handbook approach for volumetric-based design of BMPs (See

Section 5.5.1). The hourly rainfall intensities analysis is part of the California Stormwater BMP Handbook approach for flow-based design of BMPs (See Section 5.5.2)

## California Stormwater BMP Handbook Approach – Volume-Based Design

For each rain gauge, two charts (48-hour and 24-hour draw down times) contain four curves (Runoff Coefficient 0.25, 0.50, 0.75, and 1.00) each that show the Unit Basin Storage Volume required for various levels Capture of average annual runoff.

The charts are developed using a continuous simulation model, the STORM model, developed by the Hydrologic Engineering Center of the U.S. Army Corps of Engineers (COE-HEC, 1977). The version used for this study utilized the NetSTORM user interface. The Storage, Treatment, Overflow, Runoff Model (STORM) was applied to long-term hourly rainfall data at each site. STORM translates rainfall into runoff, then routes the runoff through detention storage. Key model assumptions are:

- Drainage Area = 100 acres
- Depression Storage = 0.06 inches
- Evaporation Rate = 0.15 inches/day
- Inter-event Time = 24 hours and 48 hours
- Time to Empty = 24 or 48 hrs
- Runoff Coefficients = 0.25, 0.50, 0.75, 1.00

The model results are presented on a unit basis, and are sufficient for use on most projects. Projects with drainage areas larger than 100 acres should be broken down into sub-areas and the method applied to each sub-area.

For more detail on the STORM model, use key words HEC and STORM on any major browser to locate numerous documents and publications related to the STORM model.

## California Stormwater BMP Handbook Approach – Flow-Based Design

For each rain gauge, a cumulative hourly rainfall intensity chart is provided. The chart shows the percentile associated with each measured hourly rainfall intensity for the period of record. A key assumption is:

- Recorded values less than or equal to 0.01 inches per hour were not included in the analysis

A few gauges have incomplete data or data extrapolated by algorithm. No attempt was made to fill in completely missing data. Where accumulated data were available and extrapolated by algorithm, the extrapolated data were used. This situation occurs when a gauge that normally

reports hourly data is unable to report hourly data for a short period, but is able to report reliable accumulated data. A few gauges only reported rainfall in 0.1 inches per hour increments. These data were used directly without adjustment, and may result in a stair-step cumulative hourly rainfall intensity curve.

Given the number of years of record, the quality of data used overall is considered to be of sufficient quality for stormwater quality design.

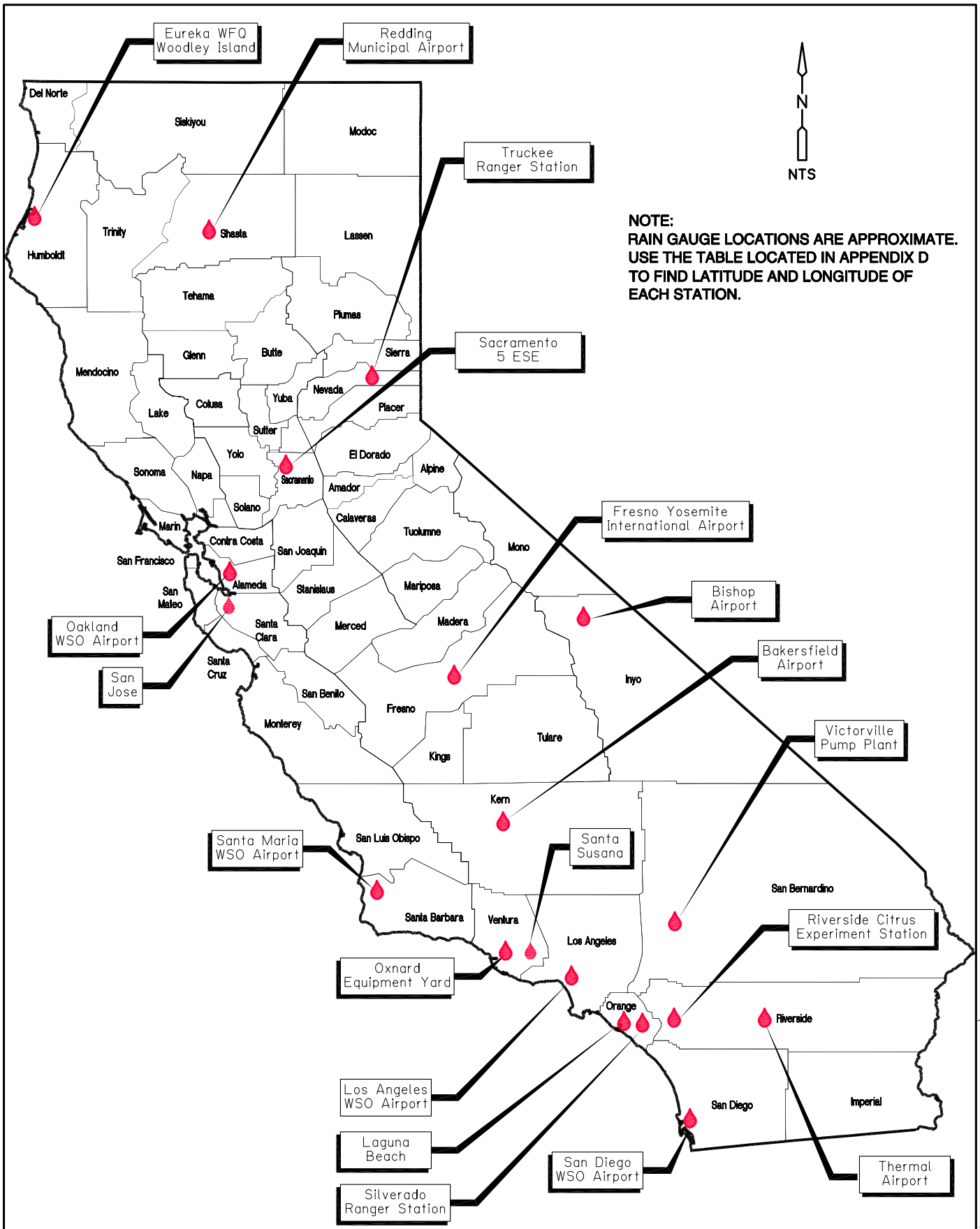

**NOTE:**  
 RAIN GAUGE LOCATIONS ARE APPROXIMATE.  
 USE THE TABLE LOCATED IN APPENDIX D  
 TO FIND LATITUDE AND LONGITUDE OF  
 EACH STATION.

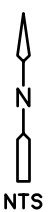

California Stormwater BMP Handbook  
 Selected Rain Gauge Index

caltrans 03/27/03 07:56 williams N:hri/ caltrans

**RAIN GAGE DATA TABLE**

GENERAL INFORMATION			LOCATION INFORMATION			
STATION NAME	NAME USED IN HANDBOOK	STATION ID	COUNTY	LAT	LONG	ELEV FT MSL
EUREKA WFO WOODLEY IS	EUREKA WFO WOODLEY ISLAND	2910	HUMBOLDT	40:48:00	124:09:00	20
REDDING MUNICIPAL AP	REDDING MUNICIPAL AIRPORT	7304	SHASTA	40:30:00	122:17:00	497
OAKLAND WSO AP	OAKLAND WSO AIRPORT	6335	ALAMEDA	37:44:00	122:12:00	6
SAN JOSE	SAN JOSE	7821	SANTA CLARA	37:21:00	121:54:00	67
SACRAMENTO 5 ESE	SACRAMENTO 5 ESE	7633	SACRAMENTO	38:33:00	121:25:00	38
TRUCKEE RS	TRUCKEE RANGER STATION	9043	NEVADA	39:19:00	120:11:00	6,020
FRESNO YOSEMITE INTL	FRESNO YOSEMITE INTERNATIONAL AIRPORT	3257	FRESNO	36:46:00	119:43:00	333
BAKERSFIELD AP	BAKERSFIELD AIRPORT	442	KERN	35:26:00	119:03:00	489
BISHOP AP	BISHOP AIRPORT	822	INYO	37:22:00	118:21:00	4,102
SANTA MARIA WSO ARPT	SANTA MARIA WSO AIRPORT	7946	SANTA BARBARA	34:54:00	120:27:00	254
LOS ANGELES WSO ARPT	LOS ANGELES WSO AIRPORT	5114	LOS ANGELES	33:56:00	118:24:00	100
LAGUNA BEACH 2	LAGUNA BEACH	4650	ORANGE	33:33:00	117:48:00	210
SILVERADO RANGER STN	SILVERADO RANGER STATION	8243	ORANGE	33:44:00	117:39:00	1,095
RIVERSIDE CITRUS EXP ST	RIVERSIDE CITRUS EXPERIMENT STATION	7473	RIVERSIDE	33:58:00	117:21:00	986
VICTORVILLE PUMP PLANT	VICTORVILLE PUMP PLANT	9325	SAN BERNARDINO	34:32:00	117:18:00	2,858
SAN DIEGO WSO AIRPORT	SAN DIEGO WSO AIRPORT	7740	SAN DIEGO	32:44:00	117:10:00	15
THERMAL AIRPORT	THERMAL AIRPORT	48892	RIVERSIDE	33:38:N	116:10:W	-112
OXNARD EQUIPMENT YARD	OXNARD EQUIPMENT YARD	168	VENTURA	34:12.0	119:12.1	35
SANTA SUSANA	SANTA SUSANA	193	VENTURA			

**RAIN GAGE DATA TABLE**

GENERAL INFORMATION			RECORD INFORMATION			
STATION NAME	NAME USED IN HANDBOOK	STATION ID	PRECIP INCREMENT	START YEAR	END YEAR	# OF YEARS
EUREKA WFO WOODLEY IS	EUREKA WFO WOODLEY ISLAND	2910	60Min Sum	1948	2001	54
REDDING MUNICIPAL AP	REDDING MUNICIPAL AIRPORT	7304	60Min Sum	1986	2001	16
OAKLAND WSO AP	OAKLAND WSO AIRPORT	6335	60Min Sum	1948	1986	37
SAN JOSE	SAN JOSE	7821	60Min Sum	1948	2001	54
SACRAMENTO 5 ESE	SACRAMENTO 5 ESE	7633	60Min Sum	1936	2001	66
TRUCKEE RS	TRUCKEE RANGER STATION	9043	60Min Sum	1948	2001	54
FRESNO YOSEMITE INTL	FRESNO YOSEMITE INTERNATIONAL AIRPORT	3257	60Min Sum	1948	2001	54
BAKERSFIELD AP	BAKERSFIELD AIRPORT	442	60Min Sum	1948	2001	54
BISHOP AP	BISHOP AIRPORT	822	60Min Sum	1948	2001	49
SANTA MARIA WSO ARPT	SANTA MARIA WSO AIRPORT	7946	60Min Sum	1948	2001	54
LOS ANGELES WSO ARPT	LOS ANGELES WSO AIRPORT	5114	60Min Sum	1948	2001	54
LAGUNA BEACH 2	LAGUNA BEACH	4650	60Min Sum	1948	2001	54
SILVERADO RANGER STN	SILVERADO RANGER STATION	8243	60Min Sum	1948	2001	53
RIVERSIDE CITRUS EXP ST	RIVERSIDE CITRUS EXPERIMENT STATION	7473	60Min Sum	1948	2001	54
VICTORVILLE PUMP PLANT	VICTORVILLE PUMP PLANT	9325	60Min Sum	1948	2001	54
SAN DIEGO WSO AIRPORT	SAN DIEGO WSO AIRPORT	7740	60Min Sum	1948	2001	54
THERMAL AIRPORT	THERMAL AIRPORT	48892		1950	2002	
OXNARD EQUIPMENT YARD	OXNARD EQUIPMENT YARD	168		1956	1996	40
SANTA SUSANA	SANTA SUSANA	193		1956	1998	42

**RAIN GAGE DATA TABLE**

GENERAL INFORMATION			RAINFALL STATISTICS			
STATION NAME	NAME USED IN HANDBOOK	STATION ID	AVG IN.	MAX IN.	MIN IN.	P6 IN
EUREKA WFO WOODLEY IS	EUREKA WFO WOODLEY ISLAND	2910	38.34	67.21	21.71	0.65
REDDING MUNICIPAL AP	REDDING MUNICIPAL AIRPORT	7304				0.55
OAKLAND WSO AP	OAKLAND WSO AIRPORT	6335	18.35	29.37	8.64	0.55
SAN JOSE	SAN JOSE	7821	14.4	31.49	6.12	0.60
SACRAMENTO 5 ESE	SACRAMENTO 5 ESE	7633	19.1	34.71	6.6	0.55
TRUCKEE RS	TRUCKEE RANGER STATION	9043	23.67	55.2	11.82	0.45
FRESNO YOSEMITE INTL	FRESNO YOSEMITE INTERNATIONAL AIRPORT	3257	10.94	21.61	5.96	0.50
BAKERSFIELD AP	BAKERSFIELD AIRPORT	442	5.94	12.72	1.87	0.55
BISHOP AP	BISHOP AIRPORT	822	5.48	17.09	1.82	0.38
SANTA MARIA WSO ARPT	SANTA MARIA WSO AIRPORT	7946	12.9	27	3.3	0.65
LOS ANGELES WSO ARPT	LOS ANGELES WSO AIRPORT	5114	12.19	29.46	4.19	0.60
LAGUNA BEACH 2	LAGUNA BEACH	4650	10.75	26	2.3	0.58
SILVERADO RANGER STN	SILVERADO RANGER STATION	8243	14.85	35.1	2.39	0.55
RIVERSIDE CITRUS EXP ST	RIVERSIDE CITRUS EXPERIMENT STATION	7473	8.93	22.99	1.52	0.50
VICTORVILLE PUMP PLANT	VICTORVILLE PUMP PLANT	9325	4.23	12.9	0.69	0.47
SAN DIEGO WSO AIRPORT	SAN DIEGO WSO AIRPORT	7740	9.83	19.41	3.41	0.57
THERMAL AIRPORT	THERMAL AIRPORT	48892				0.47
OXNARD EQUIPMENT YARD	OXNARD EQUIPMENT YARD	168				0.65
SANTA SUSANA	SANTA SUSANA	193				0.55

P6 is mean storm depth. Refer to Urban Runoff Quality Management (WEF/ASCE, 1998, Page 176)



# Eureka WFO Woodley Island (2910) - Humboldt County, California

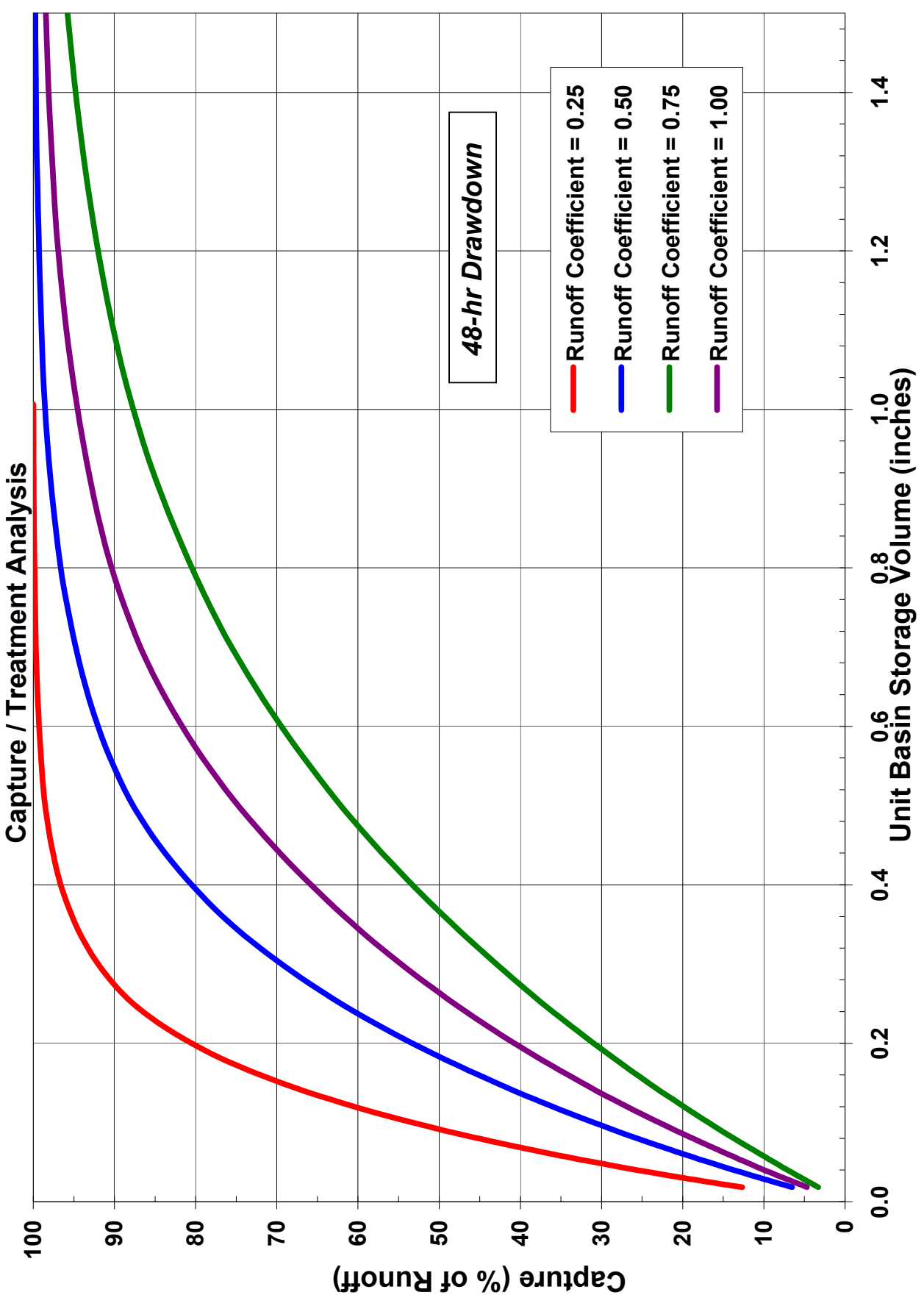

# Eureka WFO Woodley Island (2910) - Humboldt County, California

## Capture / Treatment Analysis

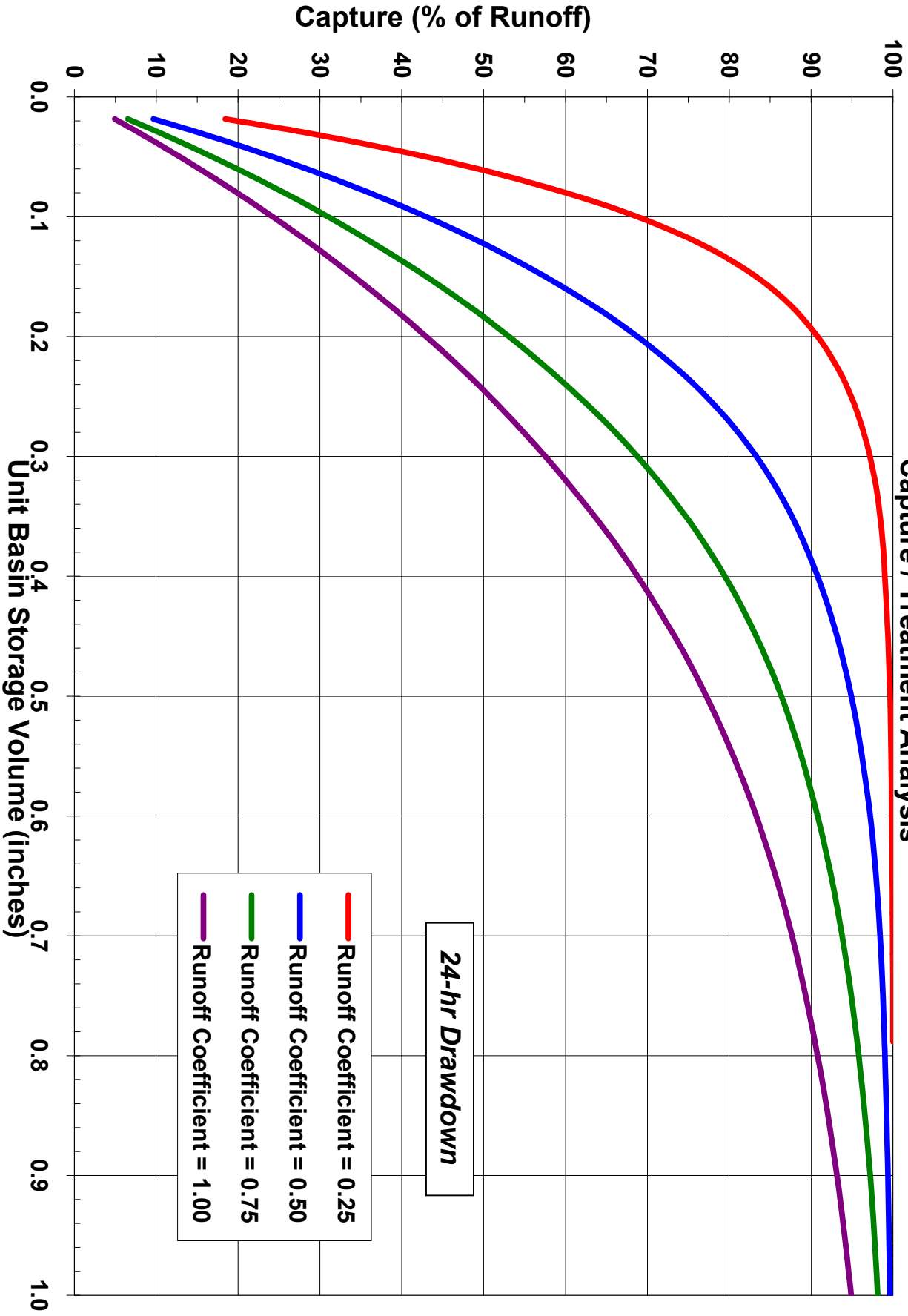

# Eureka WFO Woodley Island (2910) - Humboldt County, California

## Cumulative Frequency Hourly Rainfall Intensity

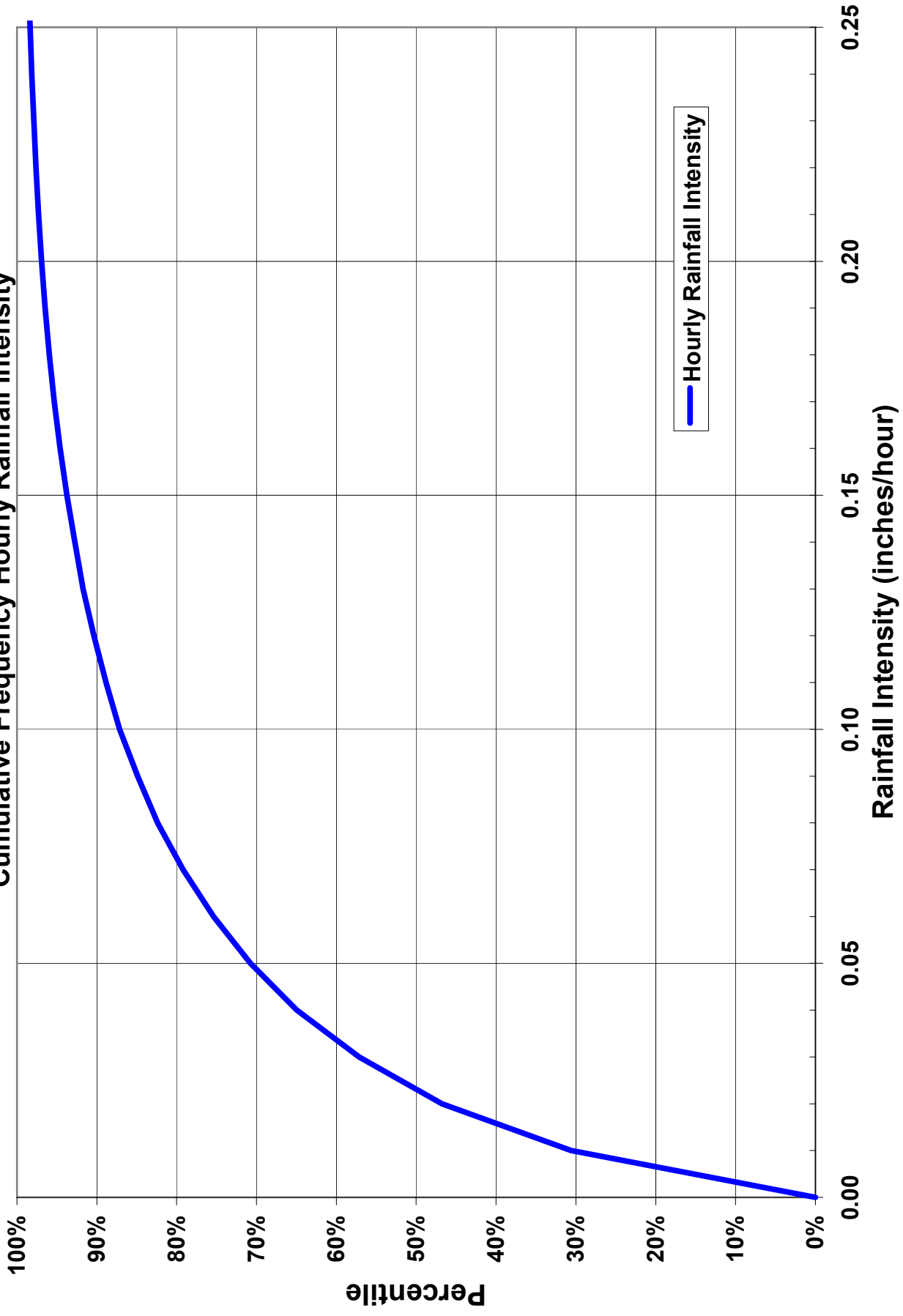

# Redding Municipal Airport (7304) - Shasta County, California

## Capture / Treatment Analysis

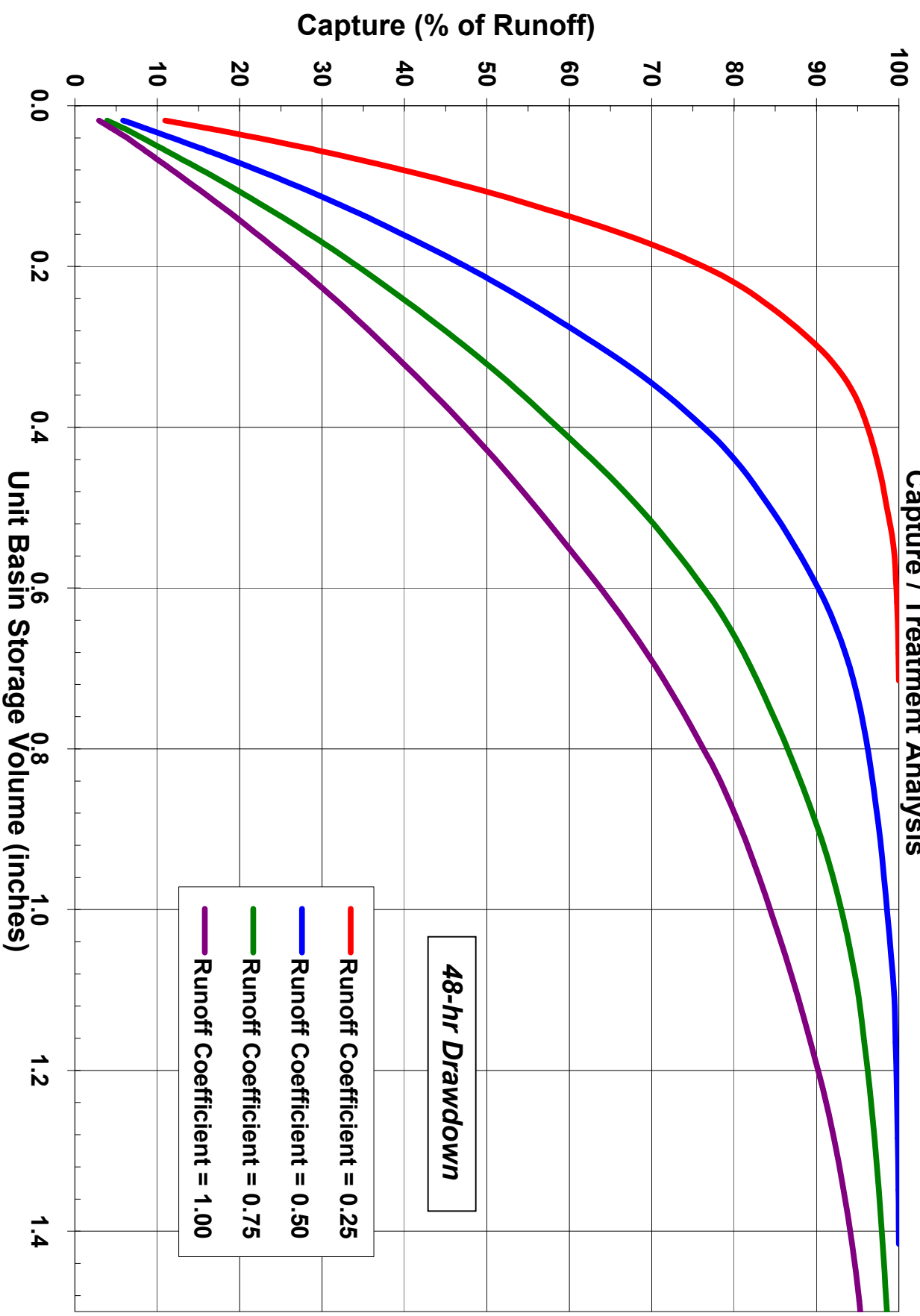

# Redding Municipal Airport (7304) - Shasta County, California

## Capture / Treatment Analysis

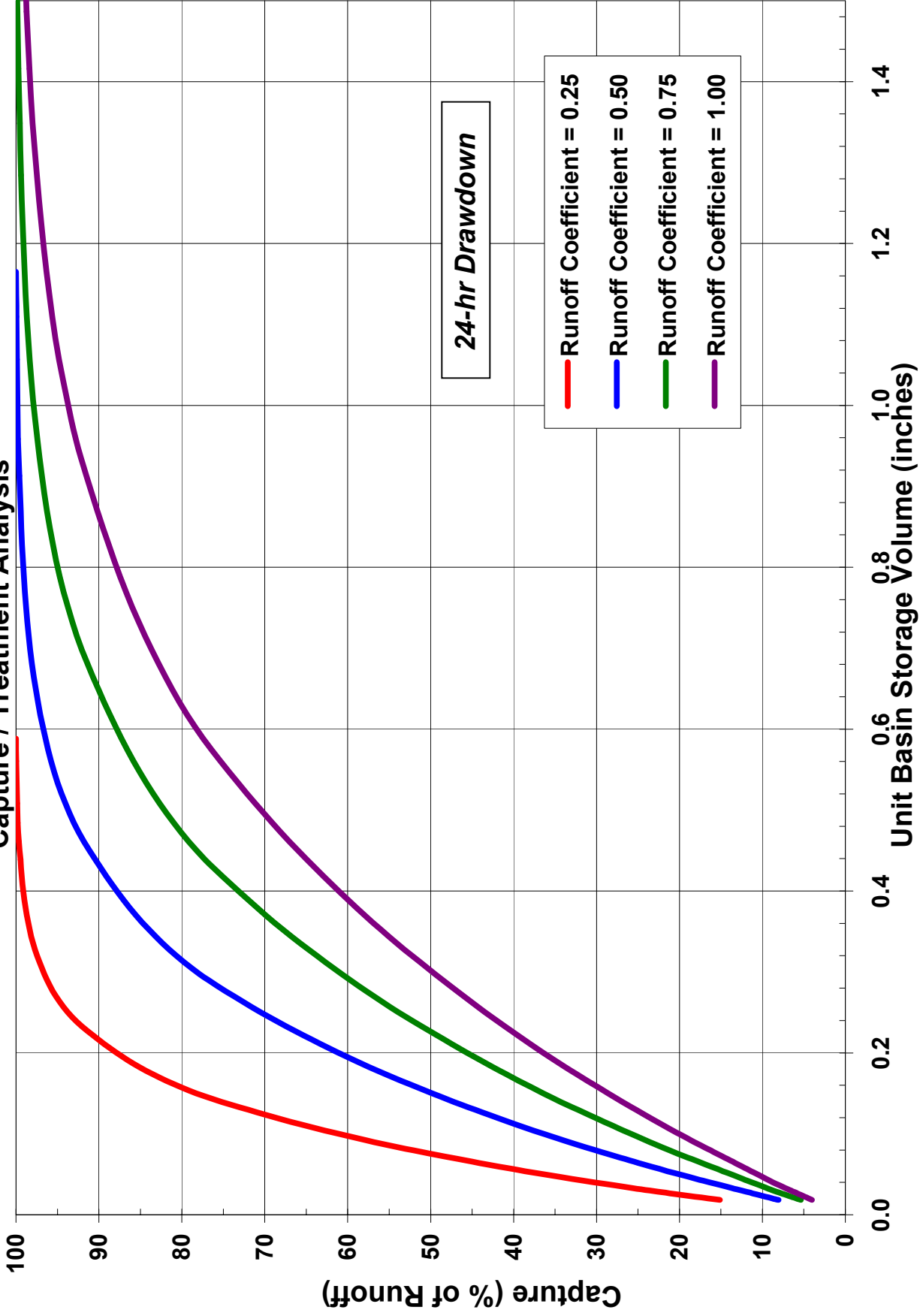

# Redding Municipal Airport (7304) - Shasta County, California Cumulative Frequency Hourly Rainfall Intensity

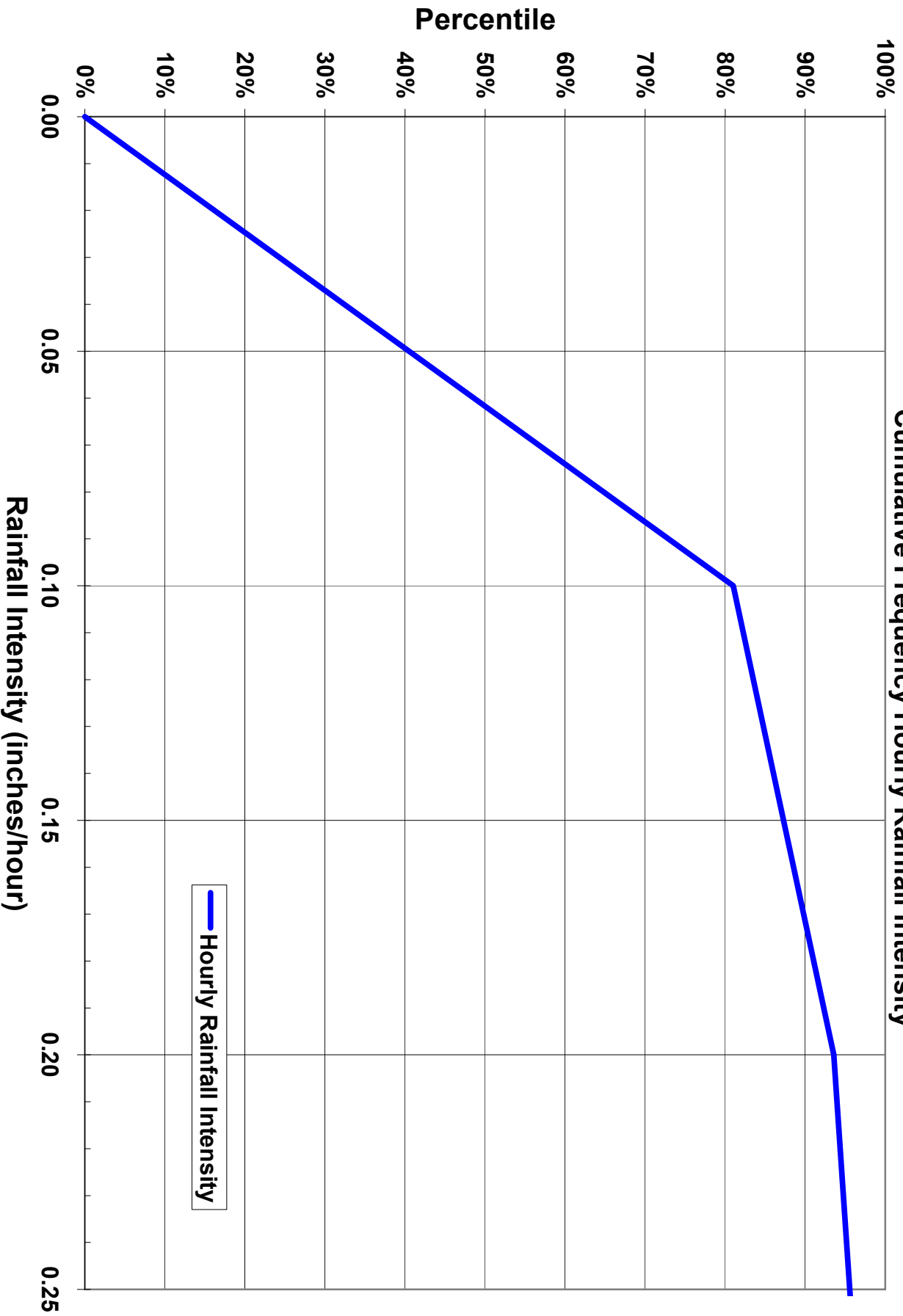

# Oakland WSO Airport (6335) - Alameda County, California

## Capture / Treatment Analysis

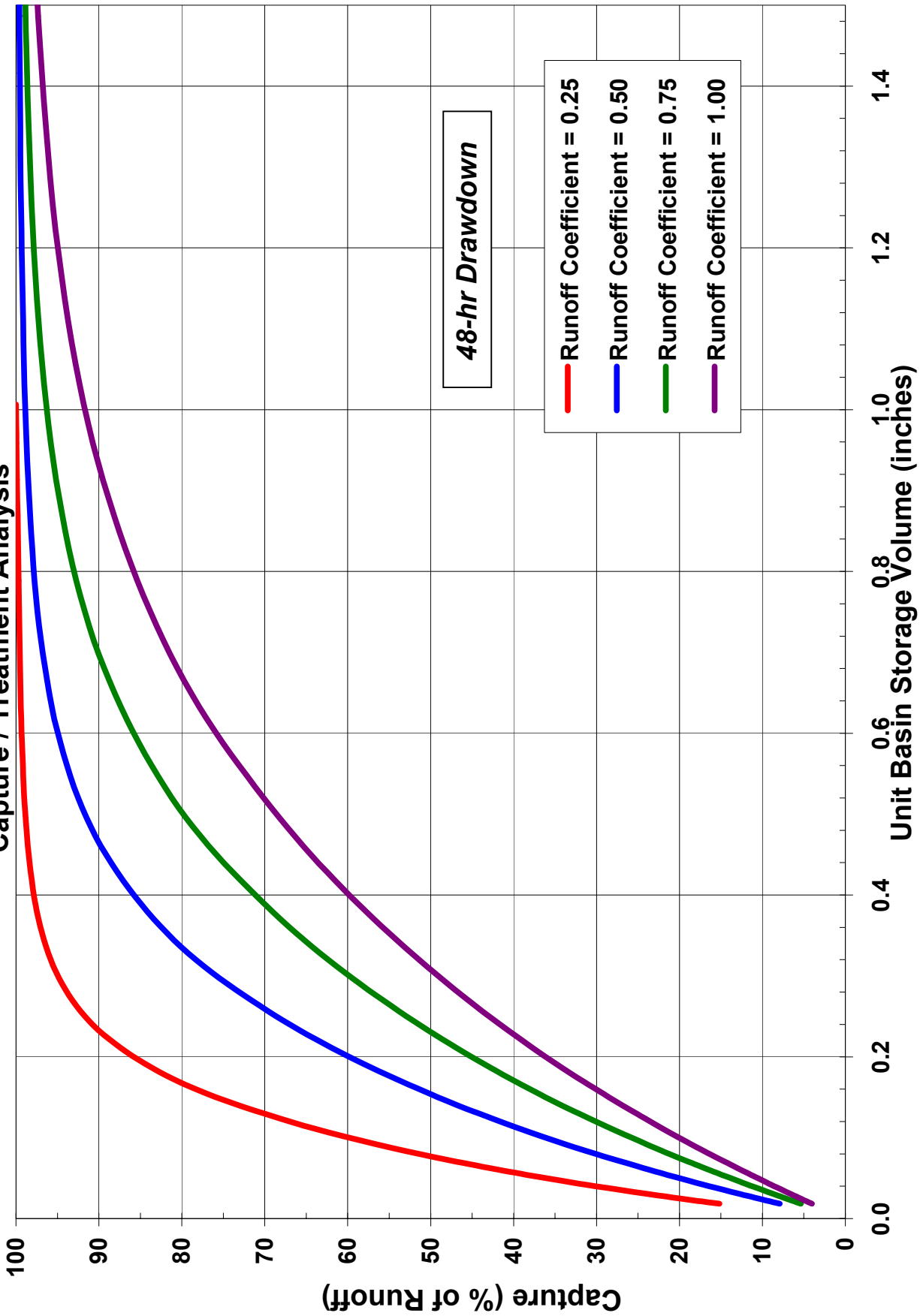

Oakland WSO Airport (6335) - Alameda County, California

Capture / Treatment Analysis

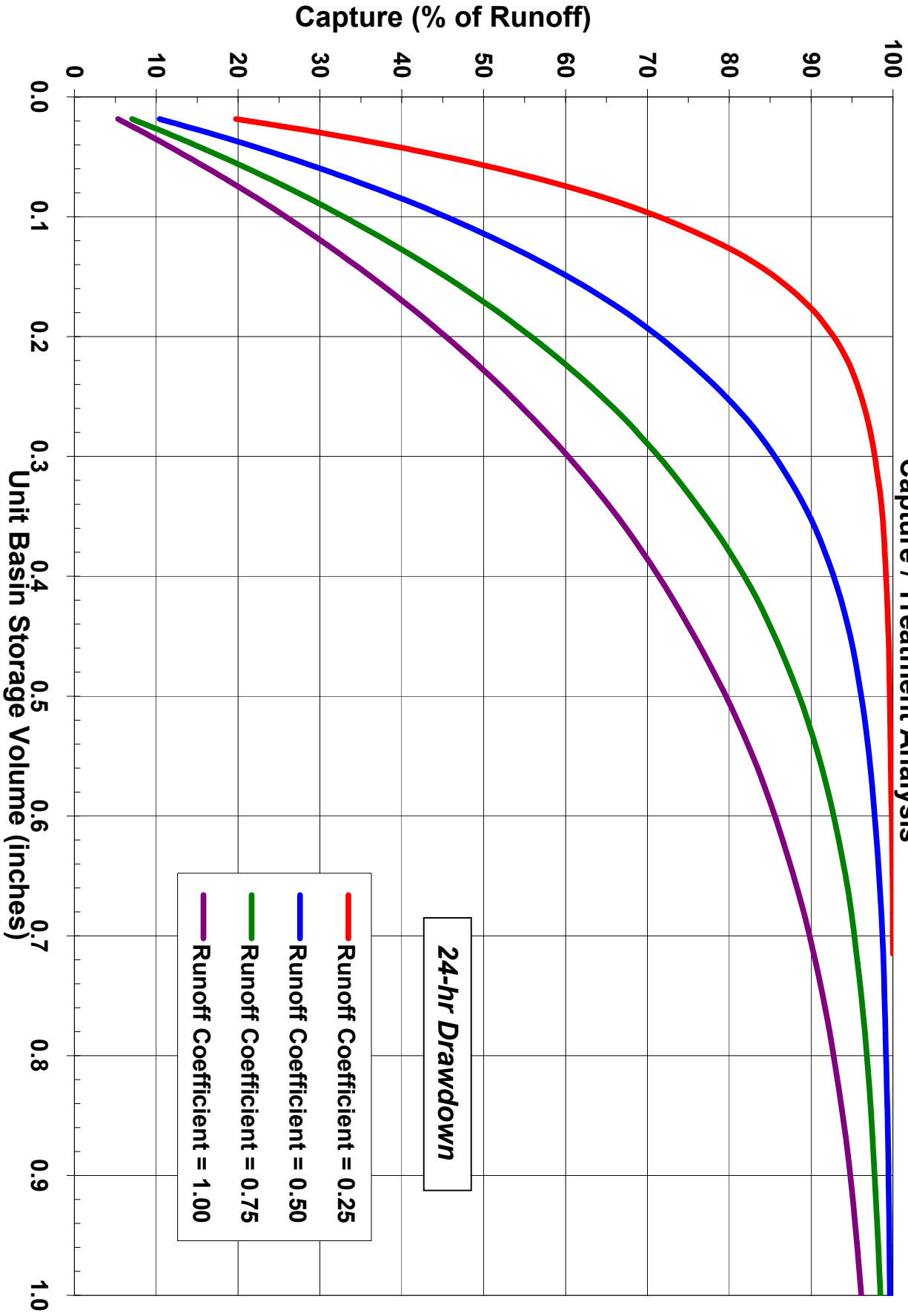

24-hr Drawdown

- Runoff Coefficient = 0.25
- Runoff Coefficient = 0.50
- Runoff Coefficient = 0.75
- Runoff Coefficient = 1.00



Oakland WSO Airport (6335) - Alameda County, California  
Cumulative Frequency Hourly Rainfall Intensity

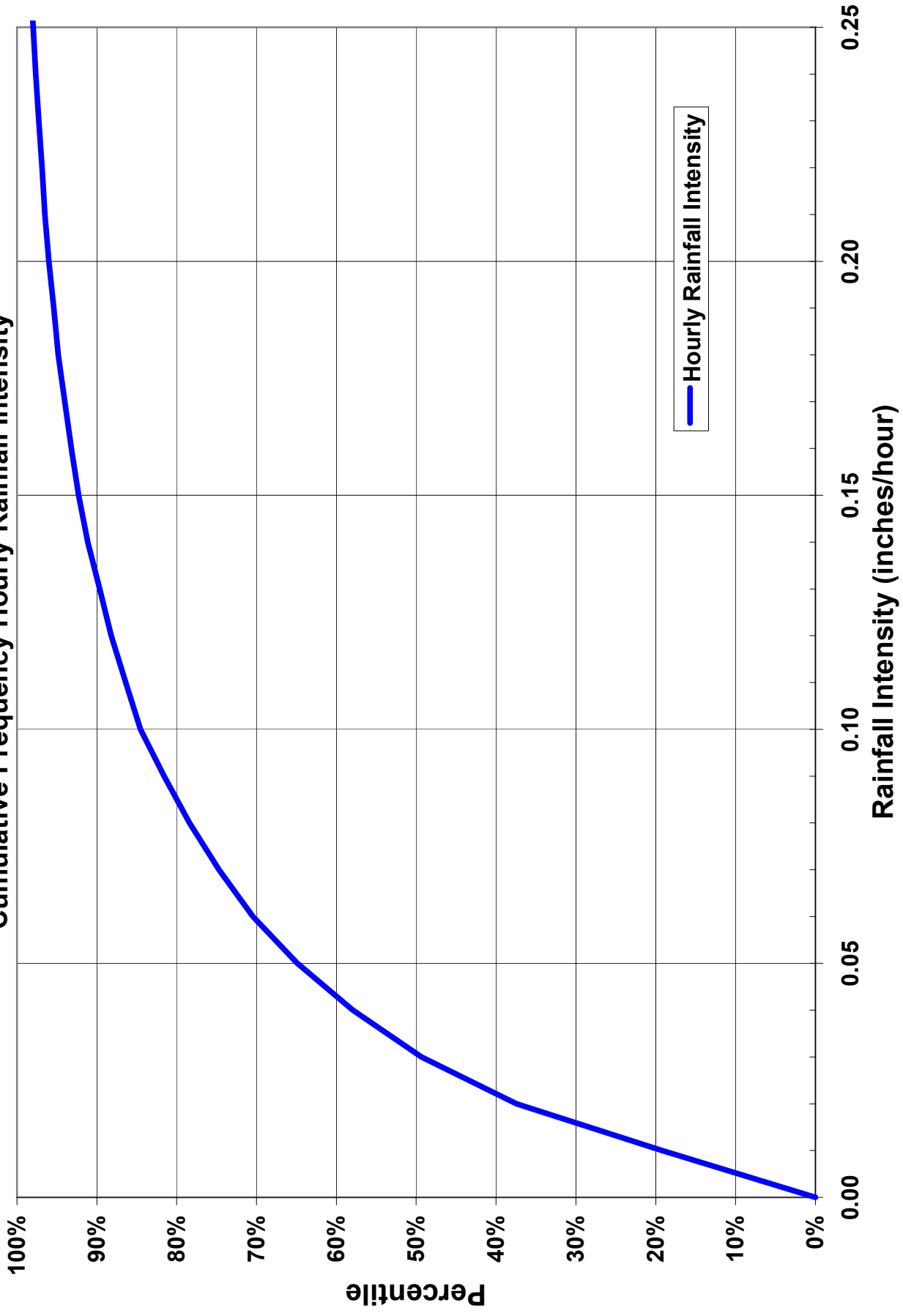

# San Jose (7821) - Santa Clara County, California

## Capture / Treatment Analysis

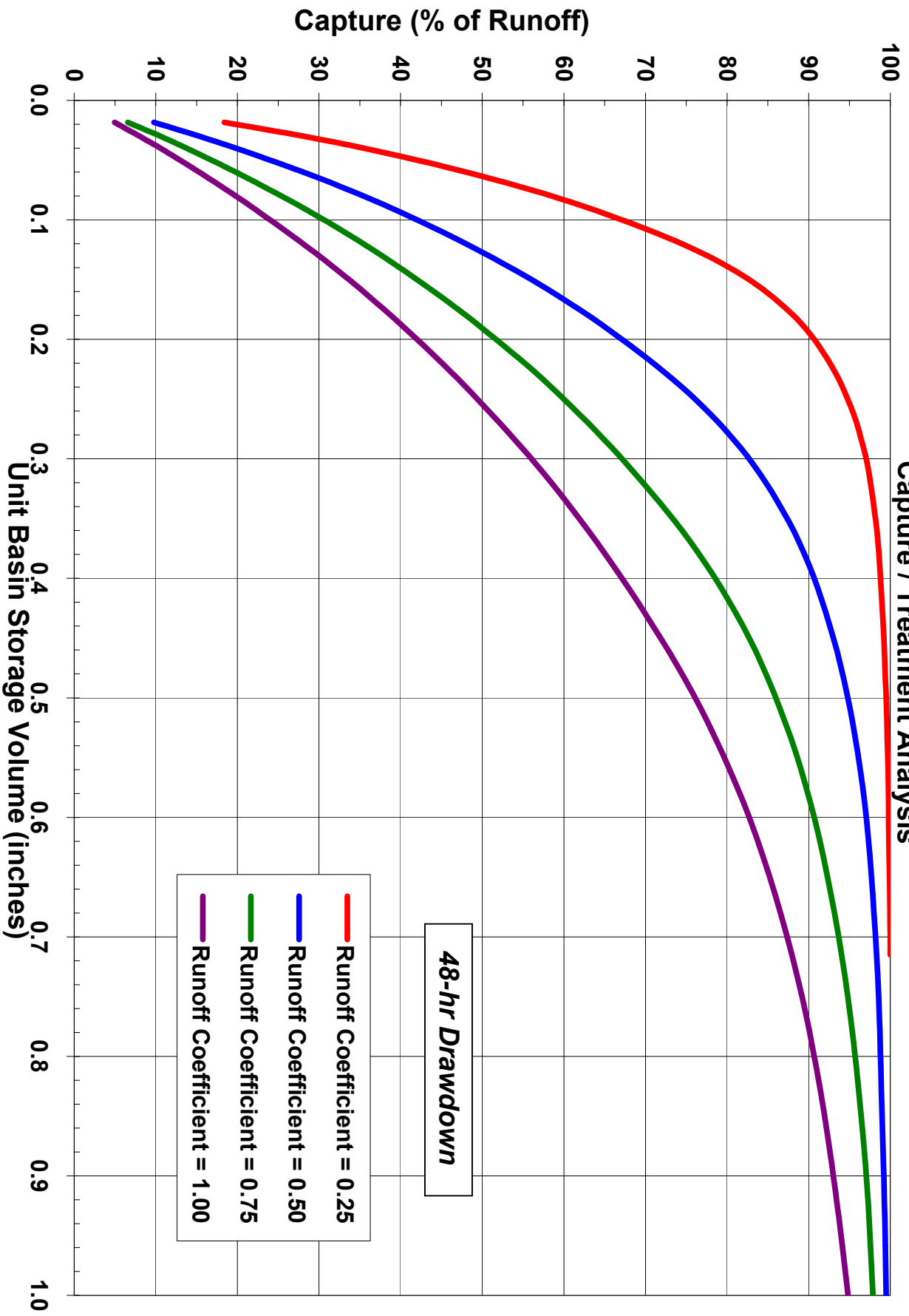

# San Jose (7821) - Santa Clara County, California

## Capture / Treatment Analysis

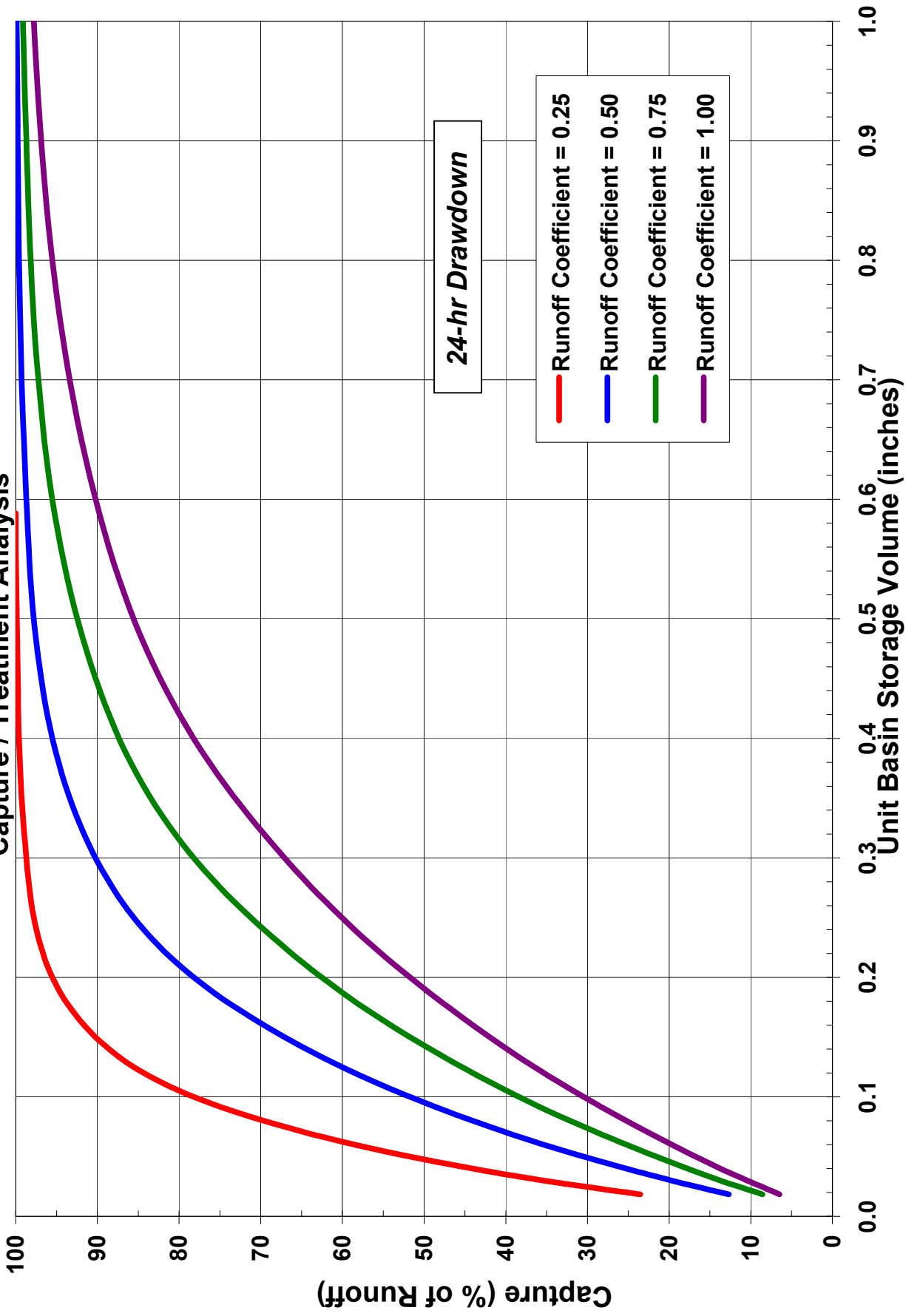

San Jose (7821) - Santa Clara County, California  
Cumulative Frequency Hourly Rainfall Intensity

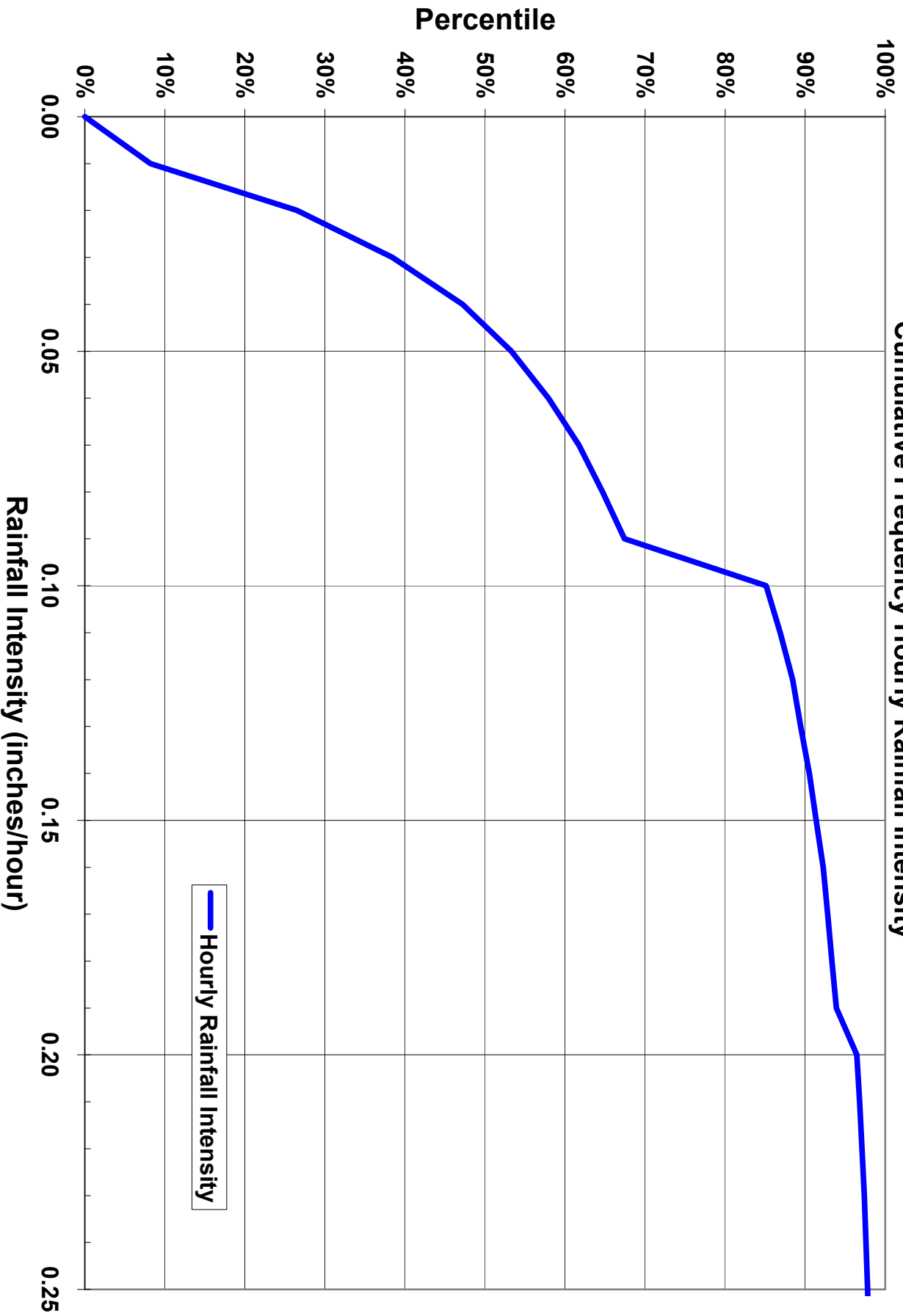

# Sacramento 5 ESE (7633) - Sacramento County, California

## Capture / Treatment Analysis

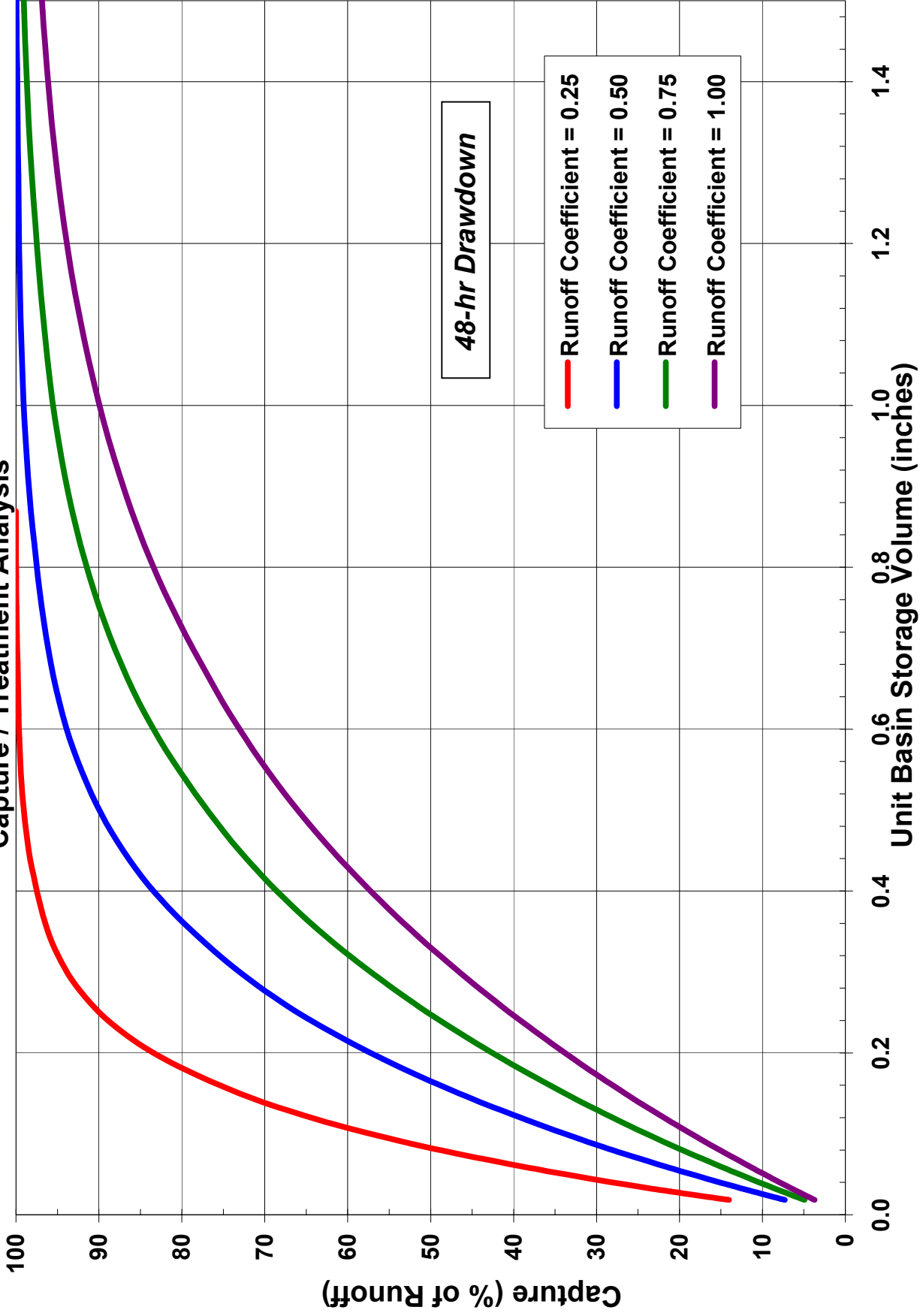

# Sacramento 5 ESE (7633) - Sacramento County, California

## Capture / Treatment Analysis

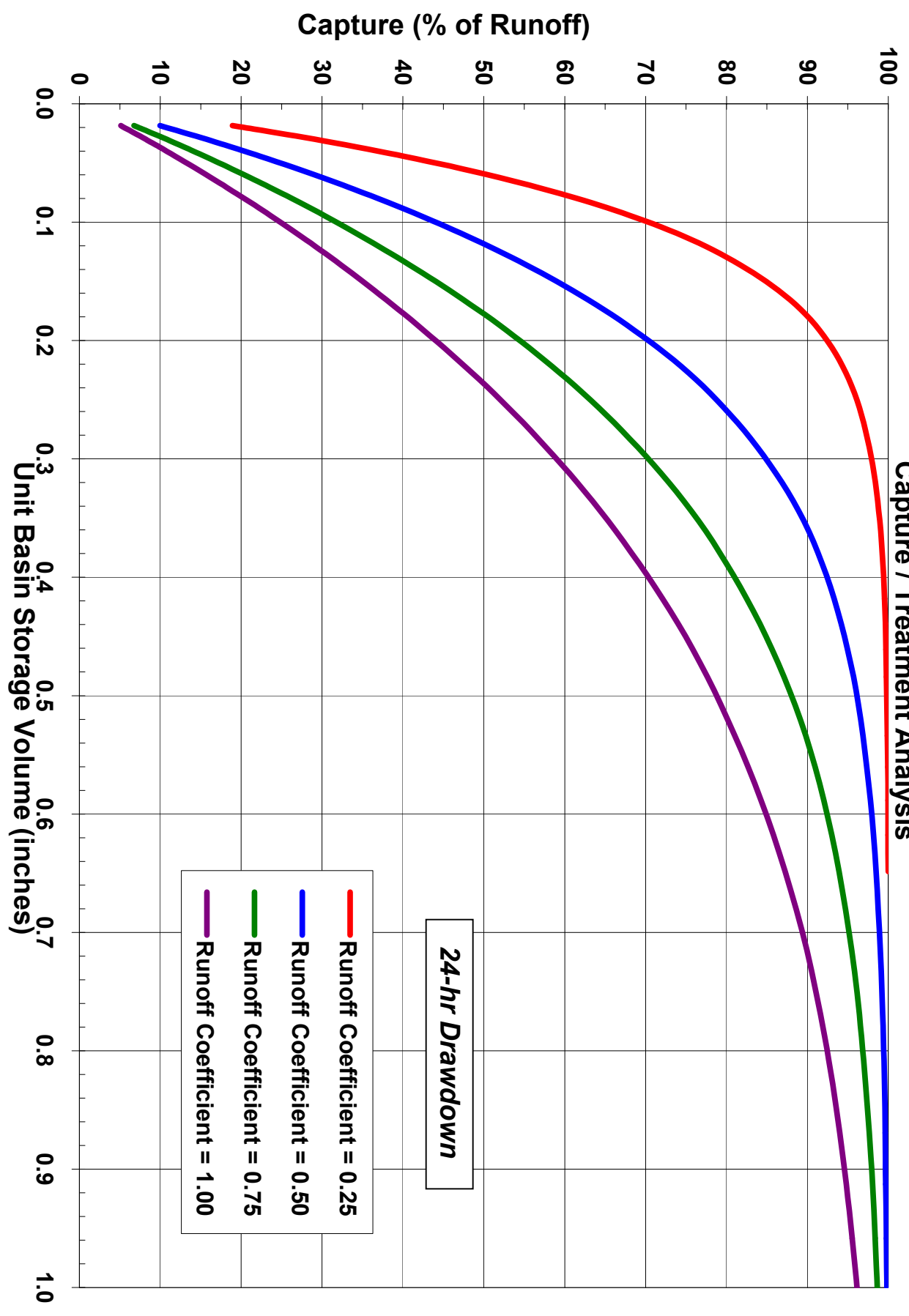

**Sacramento 5 ESE (7633) - Sacramento County, California**  
**Cumulative Frequency Hourly Rainfall Intensity**

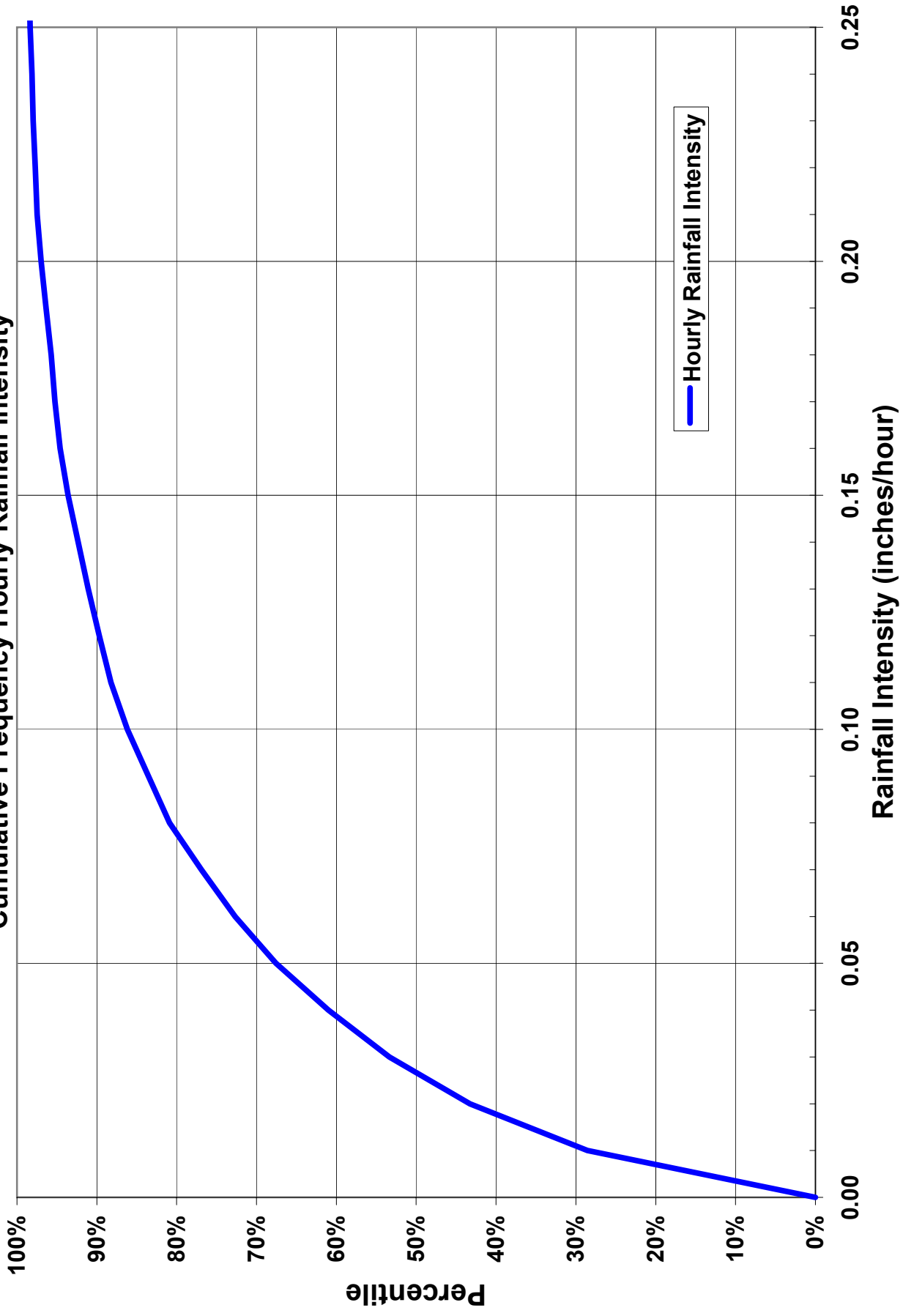

# Truckee Ranger Station (9043) - Nevada County, California

## Capture / Treatment Analysis

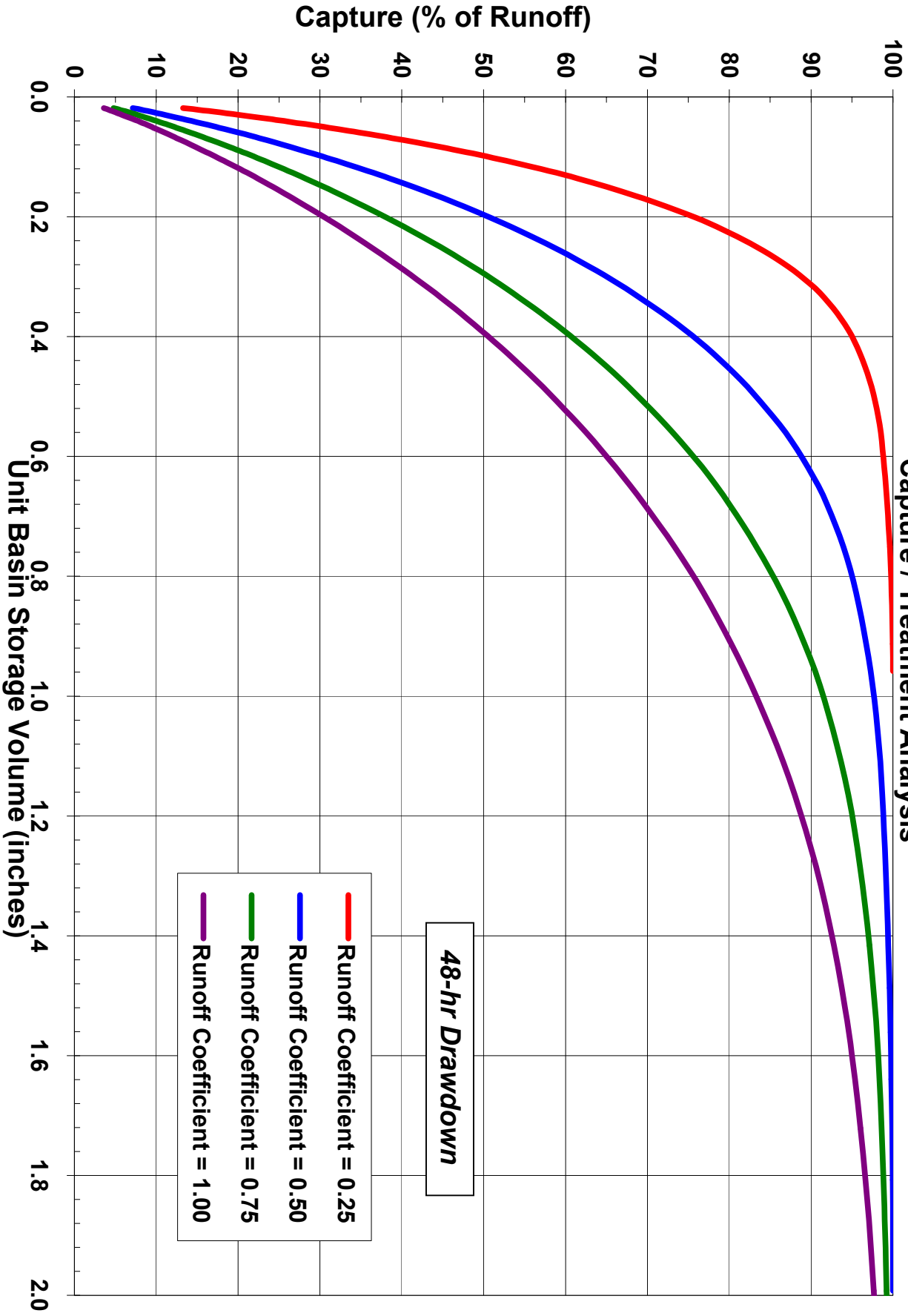

48-hr Drawdown

- Runoff Coefficient = 0.25
- Runoff Coefficient = 0.50
- Runoff Coefficient = 0.75
- Runoff Coefficient = 1.00



# Truckee Ranger Station (9043) - Nevada County, California

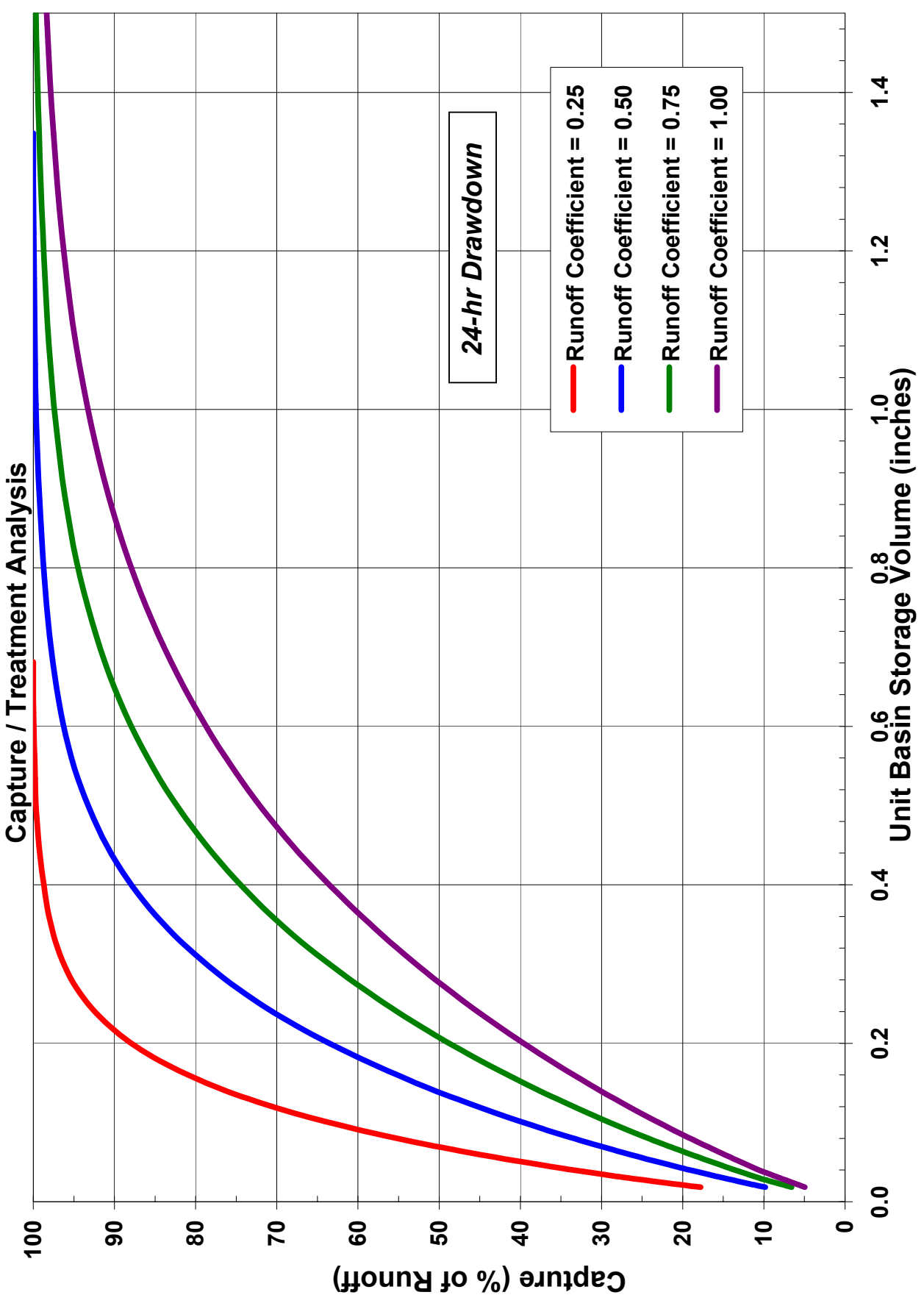

Truckee Ranger Station (9043) - Nevada County, California  
Cumulative Frequency Hourly Rainfall Intensity

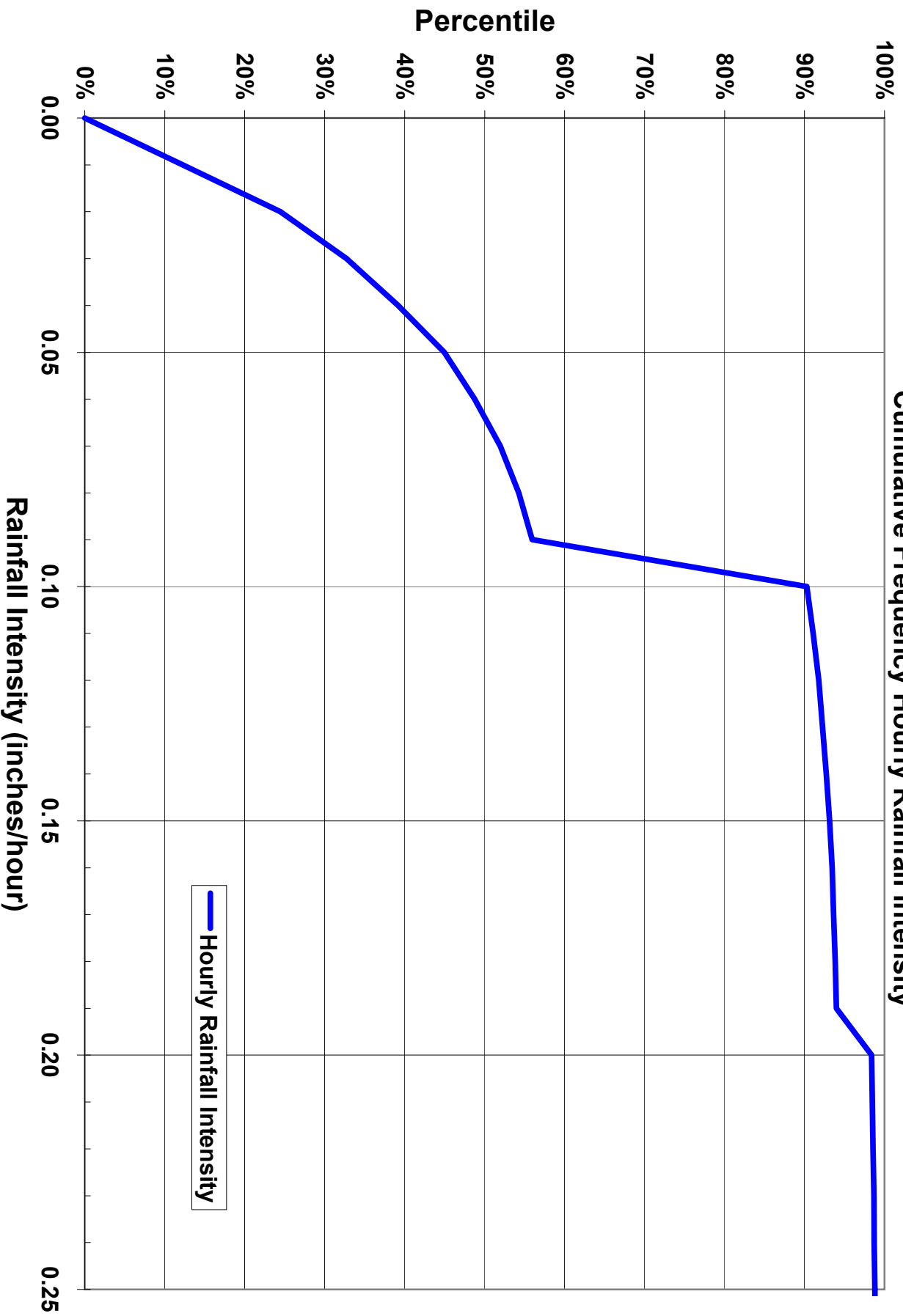

# Fresno Yosemite International Airport (3257) Fresno County, California Capture / Treatment Analysis

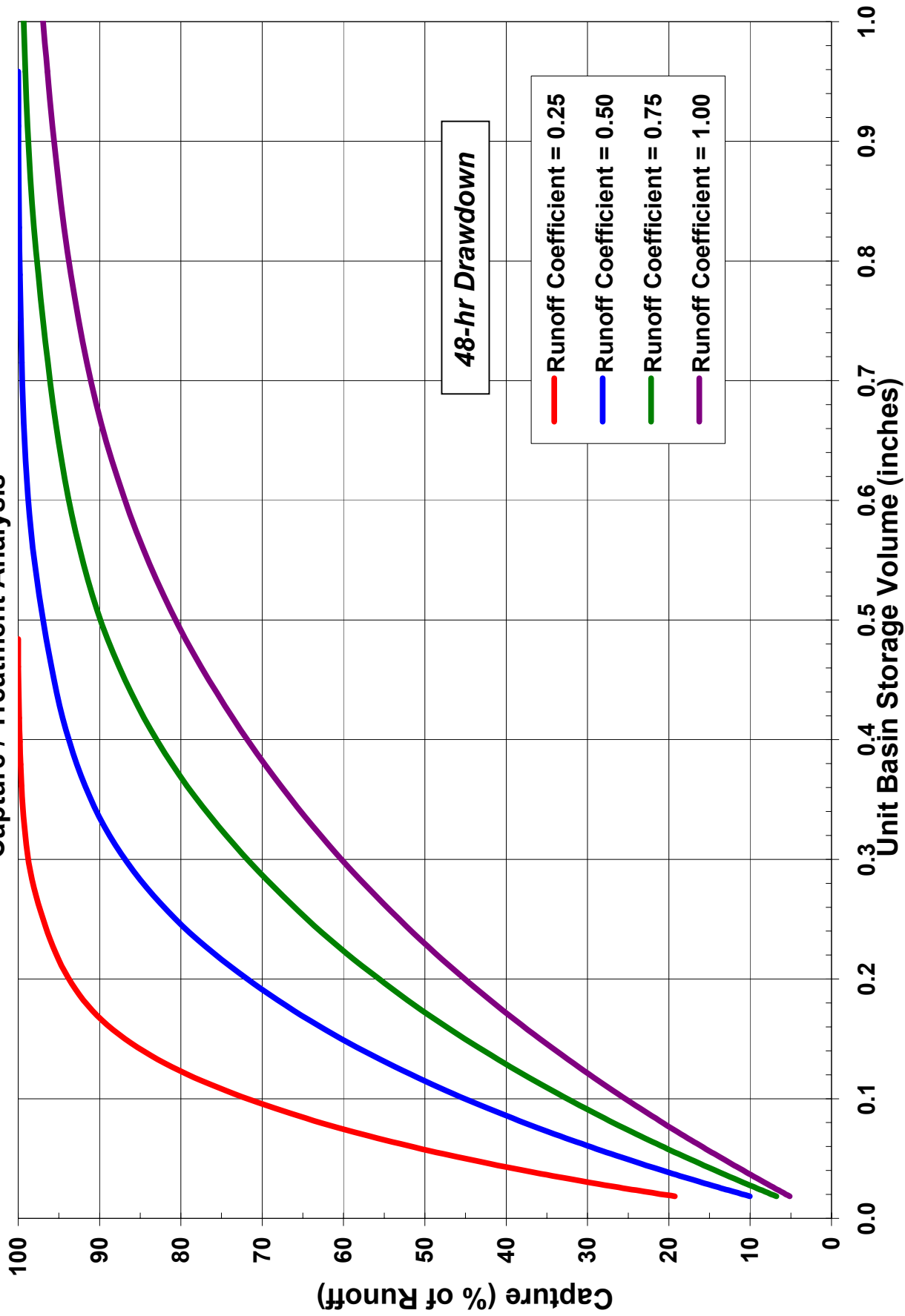

# Fresno Yosemite International Airport (3257) Fresno County, California

## Capture / Treatment Analysis

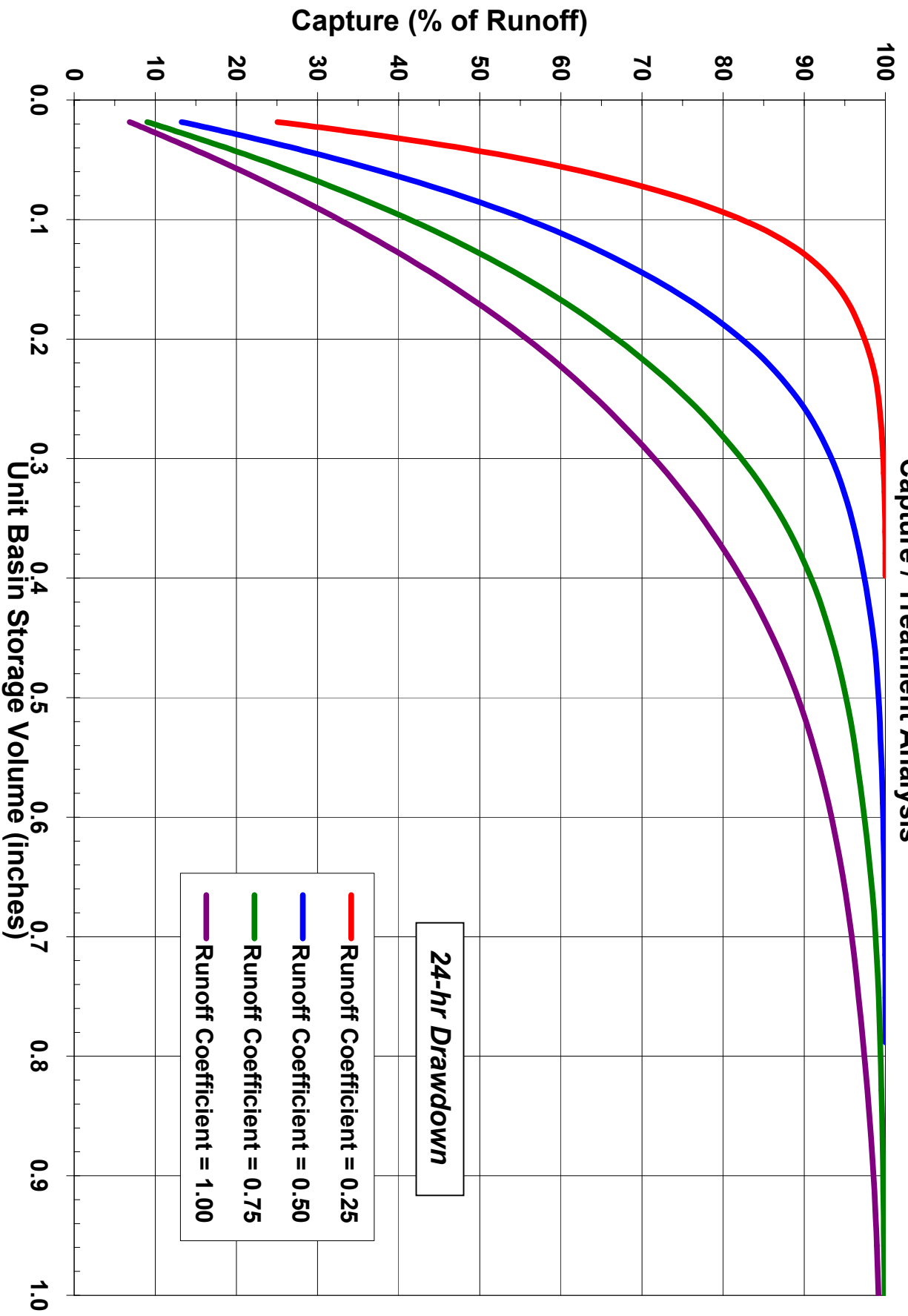

24-hr Drawdown

- Runoff Coefficient = 0.25
- Runoff Coefficient = 0.50
- Runoff Coefficient = 0.75
- Runoff Coefficient = 1.00

**Fresno Yosemite International Airport (3257) - Fresno County, California**  
**Cumulative Frequency Hourly Rainfall Intensity**

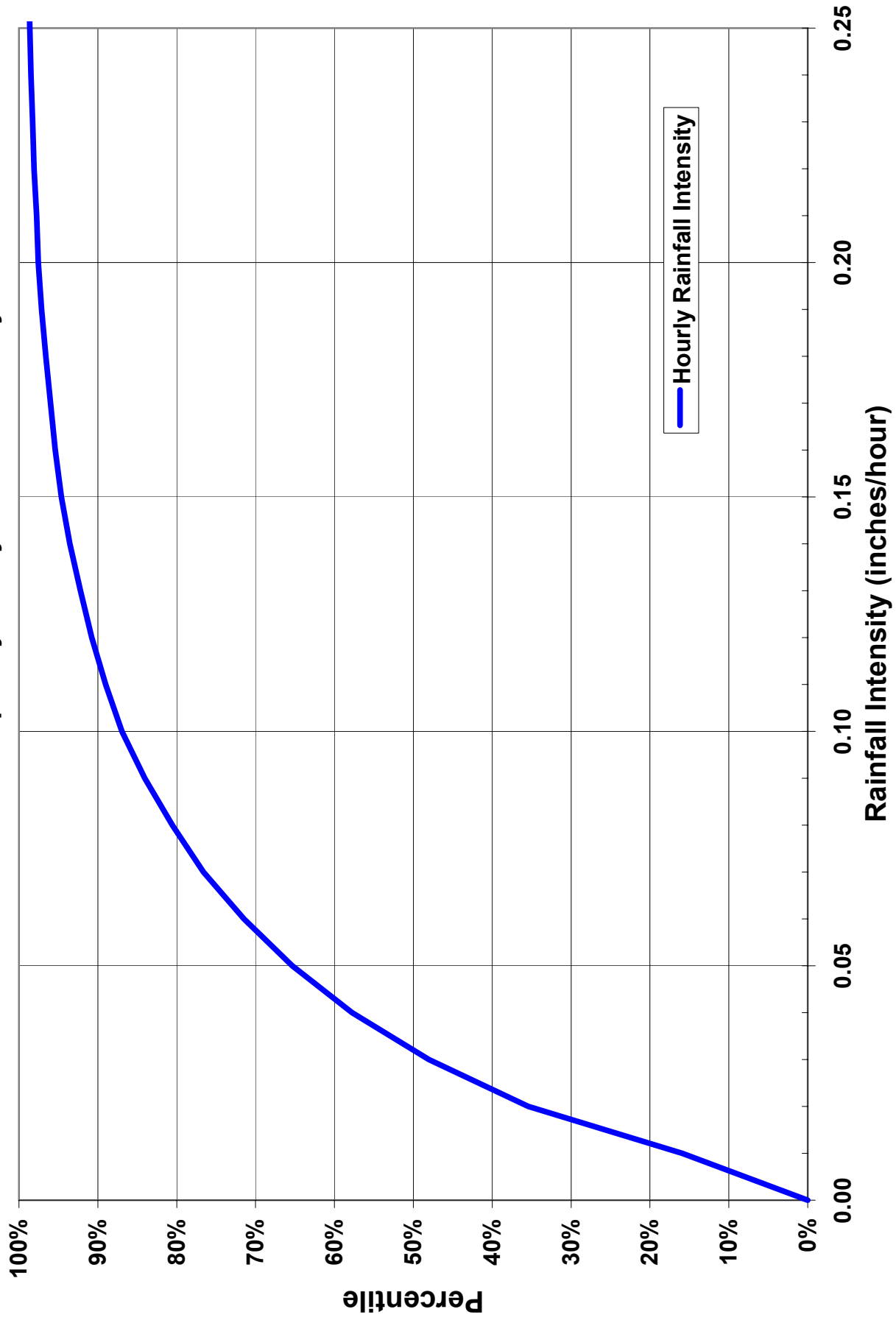

# Bakersfield Airport (442) - Kern County, California

## Capture / Treatment Analysis

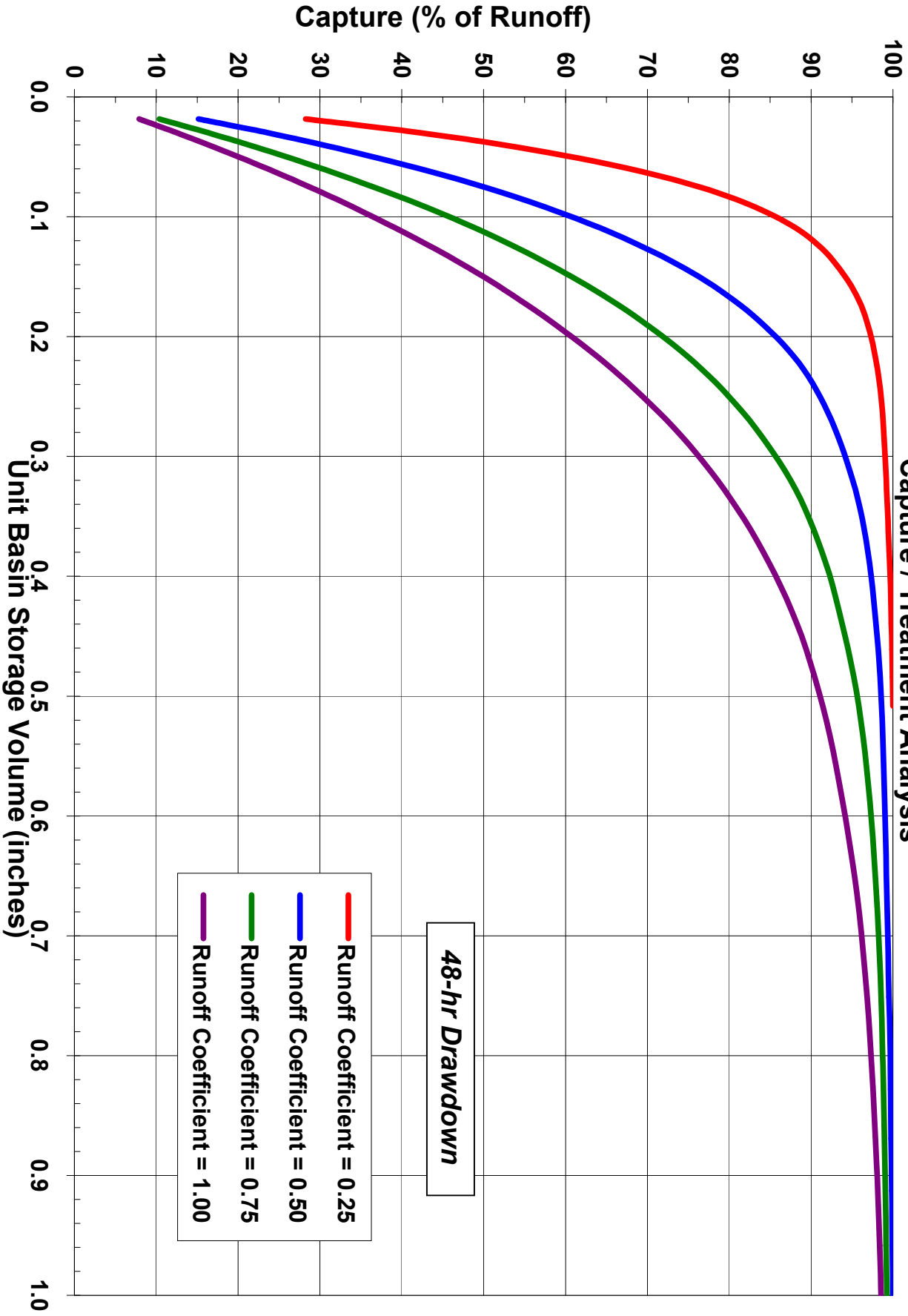

48-hr Drawdown

- Runoff Coefficient = 0.25
- Runoff Coefficient = 0.50
- Runoff Coefficient = 0.75
- Runoff Coefficient = 1.00

# Bakersfield Airport (442) - Kern County, California

## Capture / Treatment Analysis

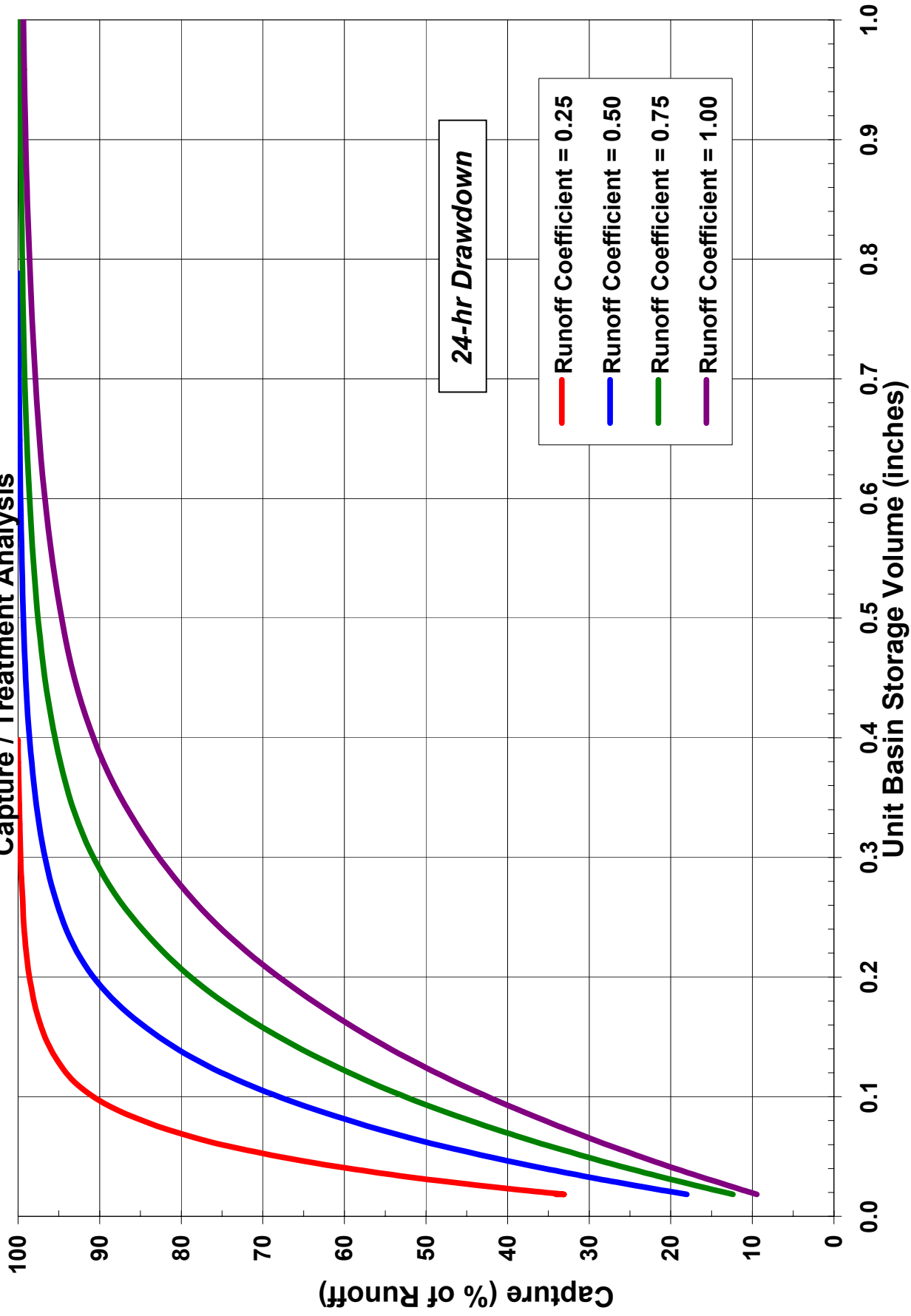

**Bakersfield Airport (442) - Kern County, California**  
**Cumulative Frequency Hourly Rainfall Intensity**

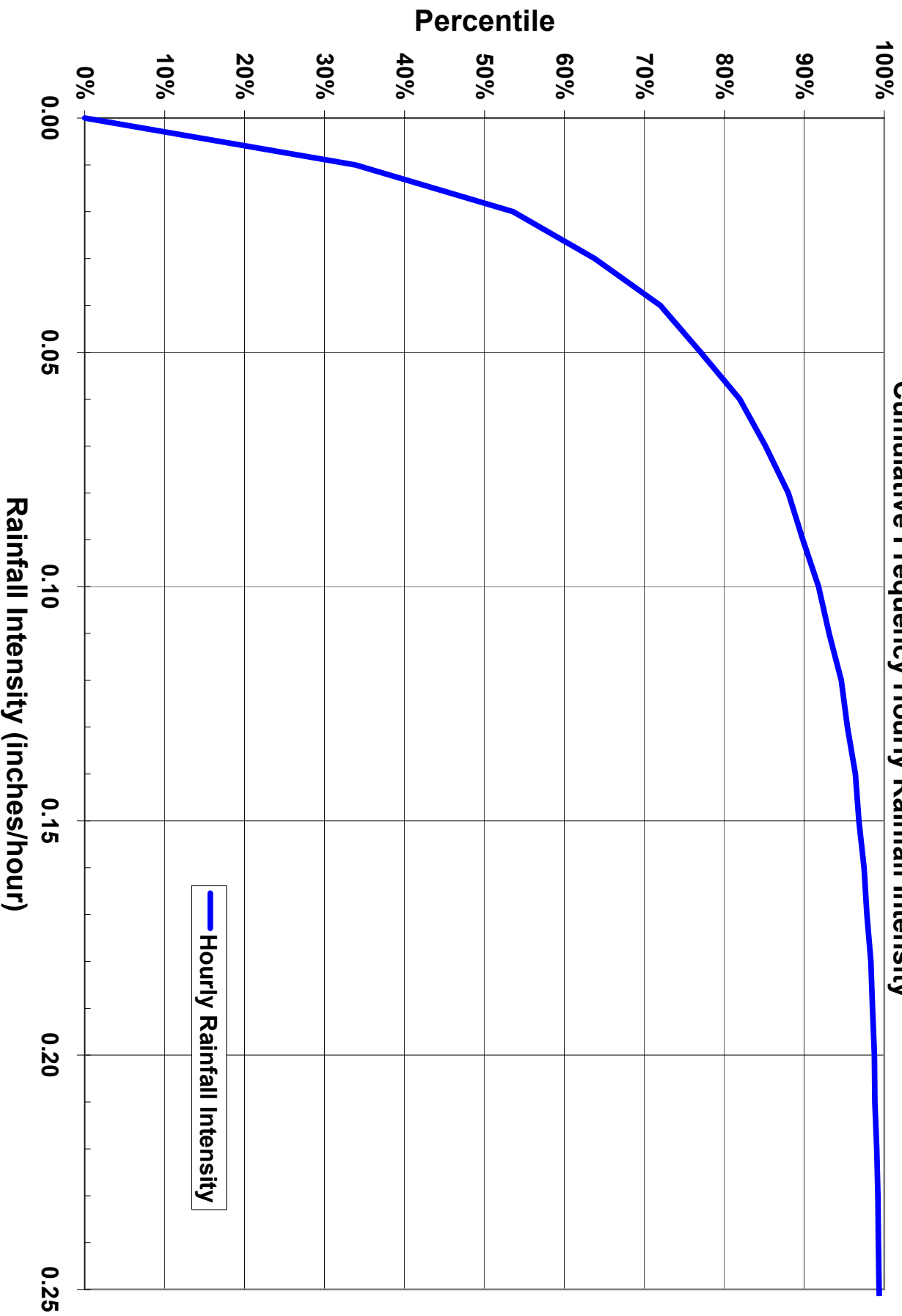



# Bishop Airport (822) - Inyo County, California

## Capture / Treatment Analysis

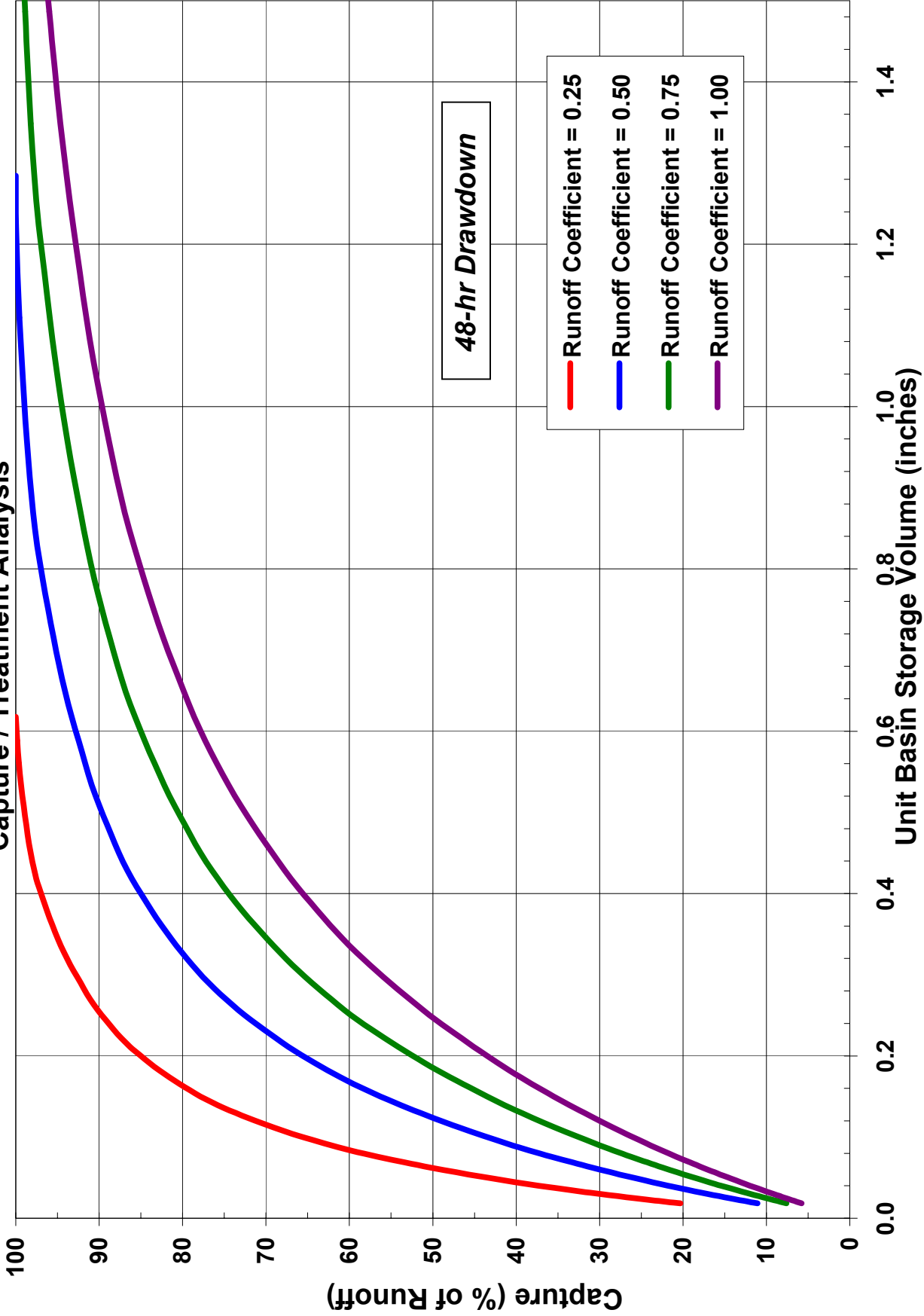

# Bishop Airport (822) - Inyo County, California Capture / Treatment Analysis

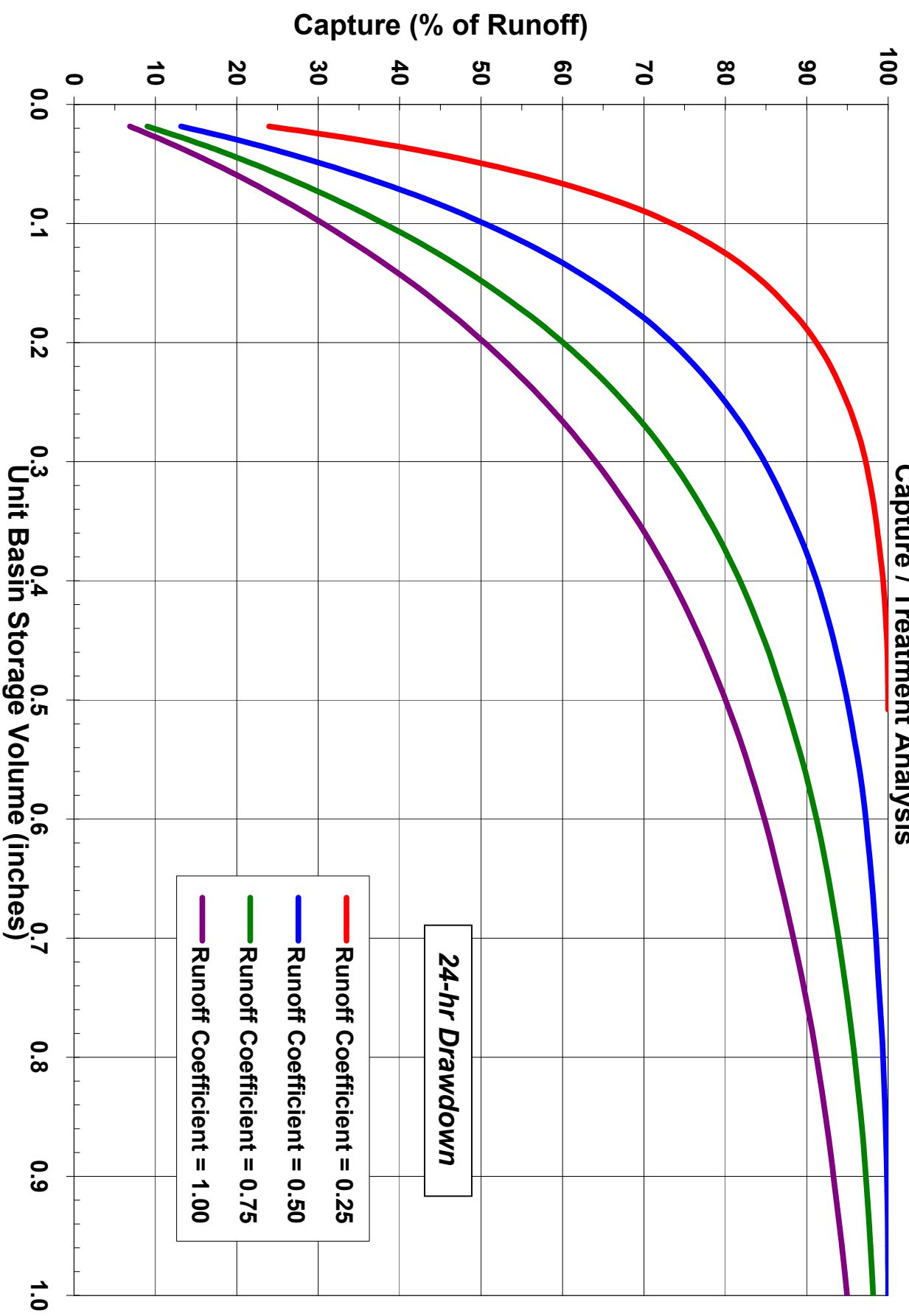

24-hr Drawdown

- Runoff Coefficient = 0.25
- Runoff Coefficient = 0.50
- Runoff Coefficient = 0.75
- Runoff Coefficient = 1.00

**Bishop Airport (822) - Inyo County, California**  
**Cumulative Frequency Hourly Rainfall Intensity**

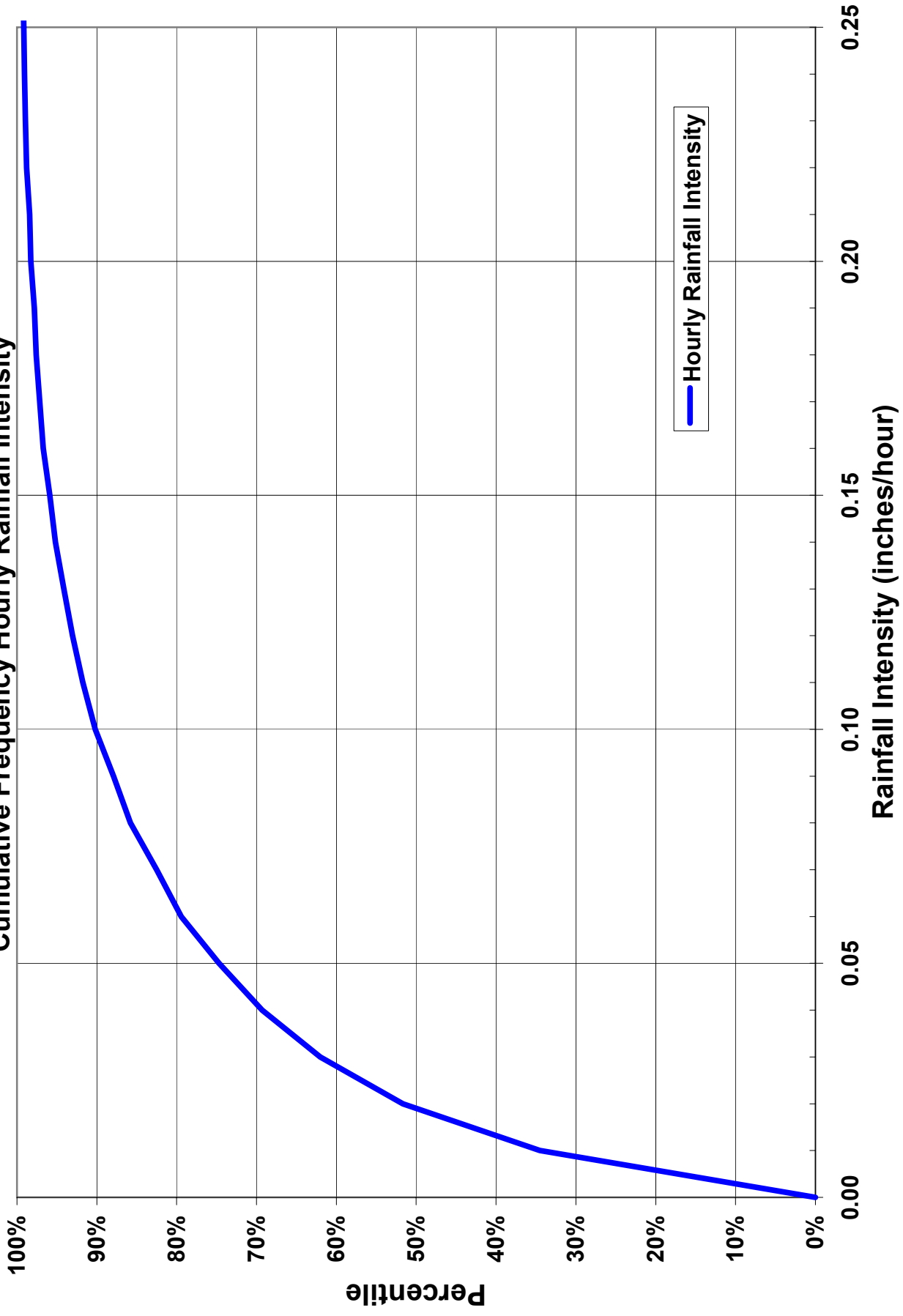

Santa Maria WSO Airport (7946) - Santa Barbara County, California  
Capture / Treatment Analysis

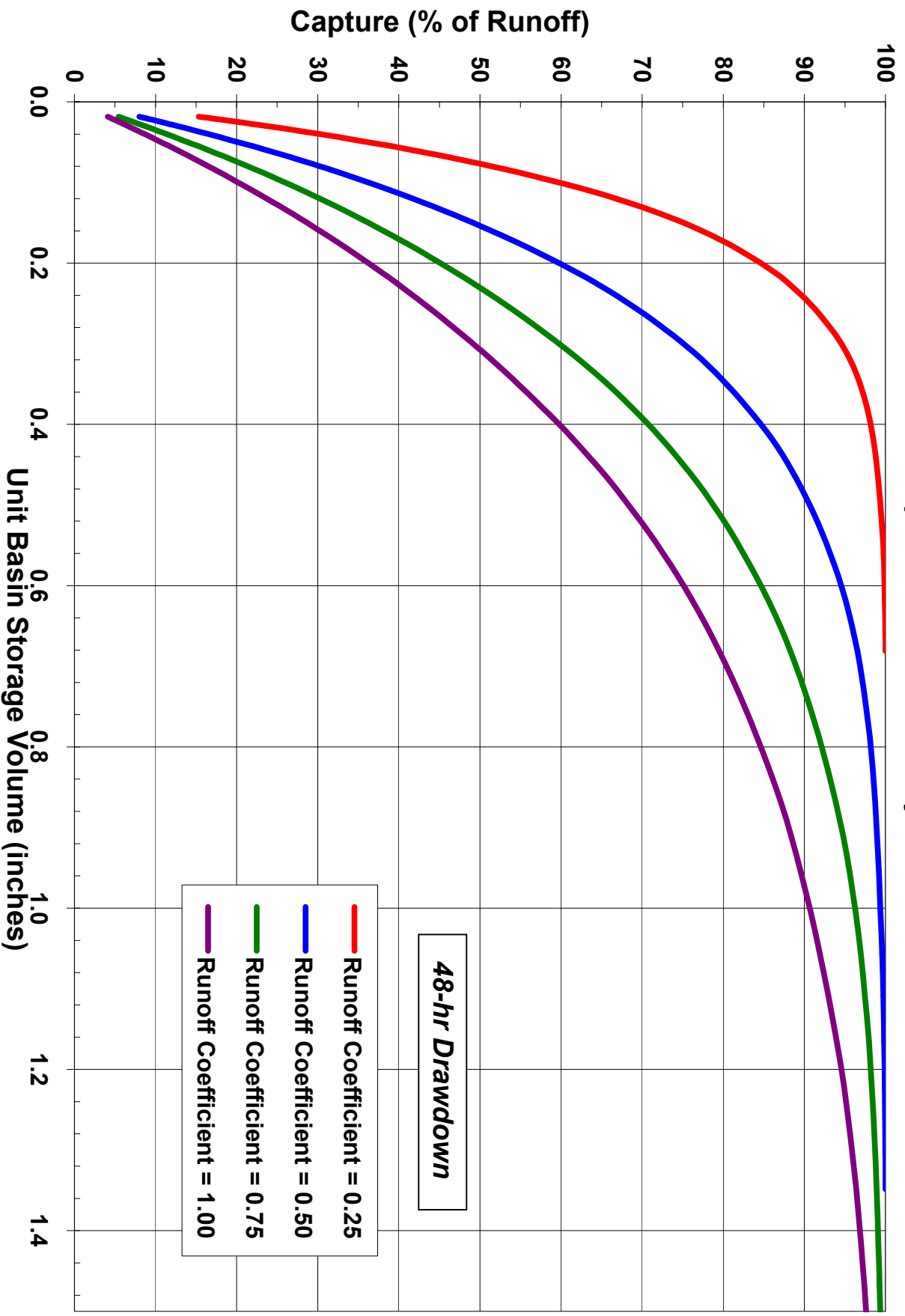

# Santa Maria WSO Airport (7946) - Santa Barbara County, California

## Capture / Treatment Analysis

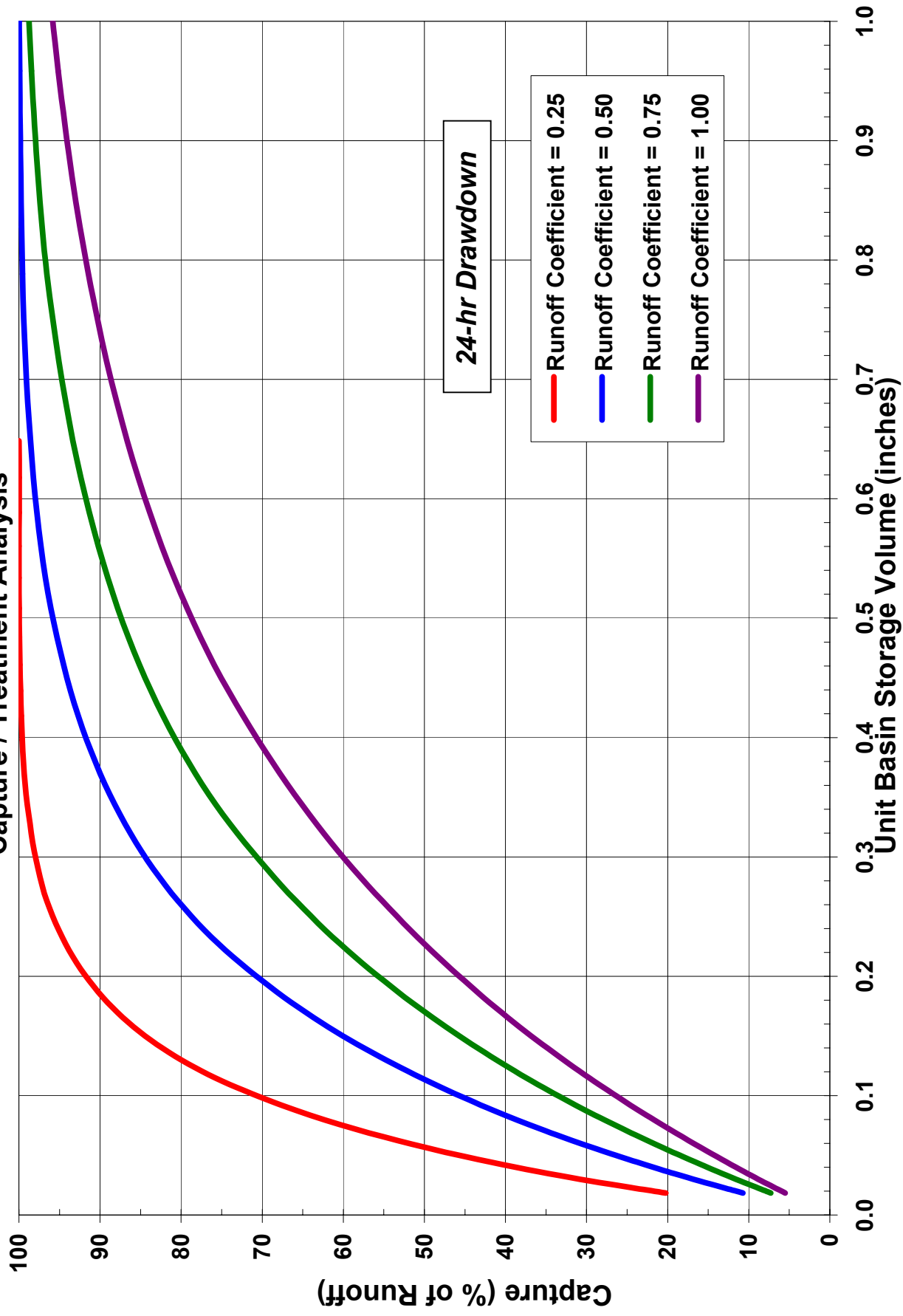

Santa Maria WSO Airport (7946) - Santa Barbara County, California  
Cumulative Frequency Hourly Rainfall Intensity

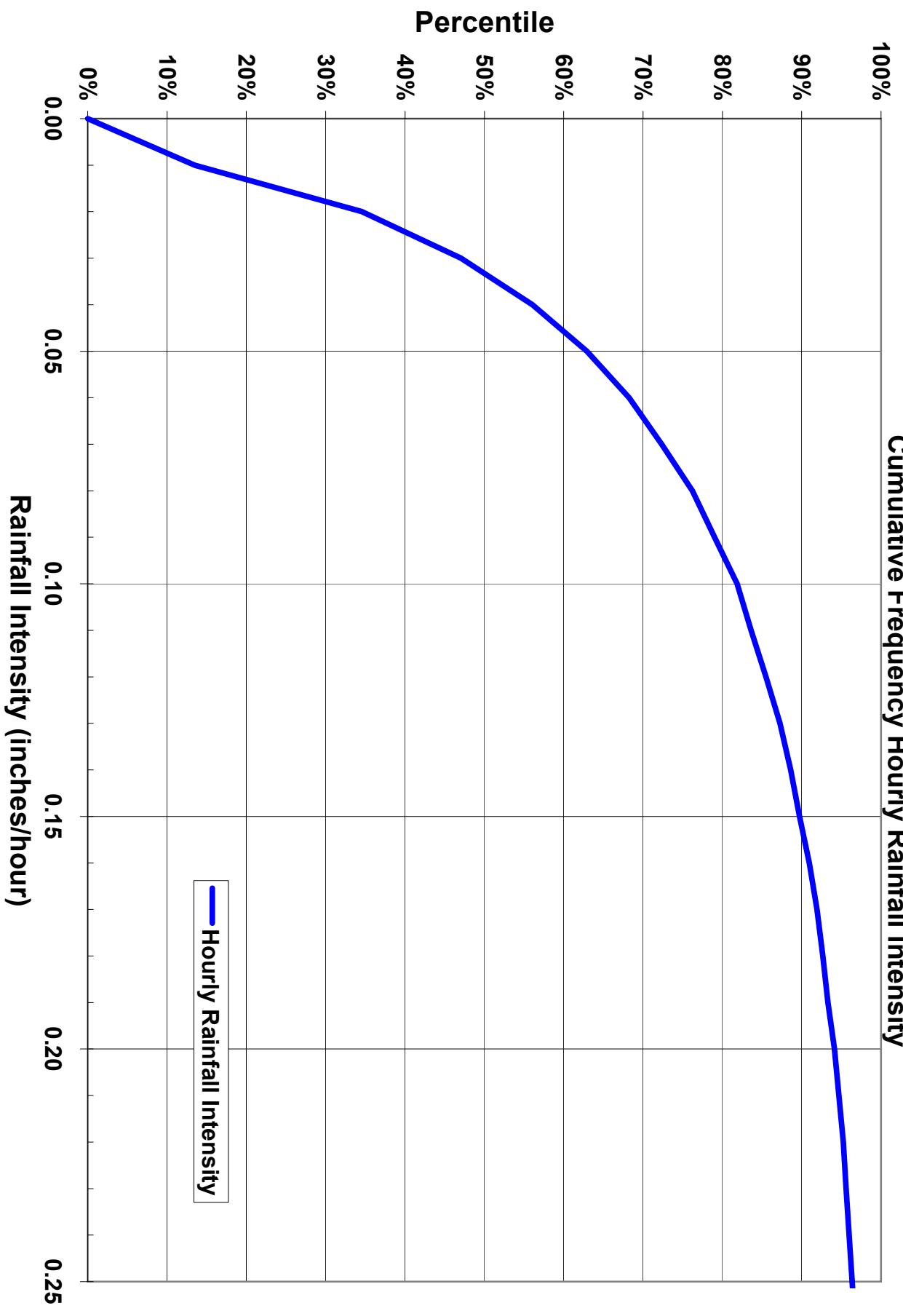

# Oxnard Equipment Yard (168) - Ventura County, California

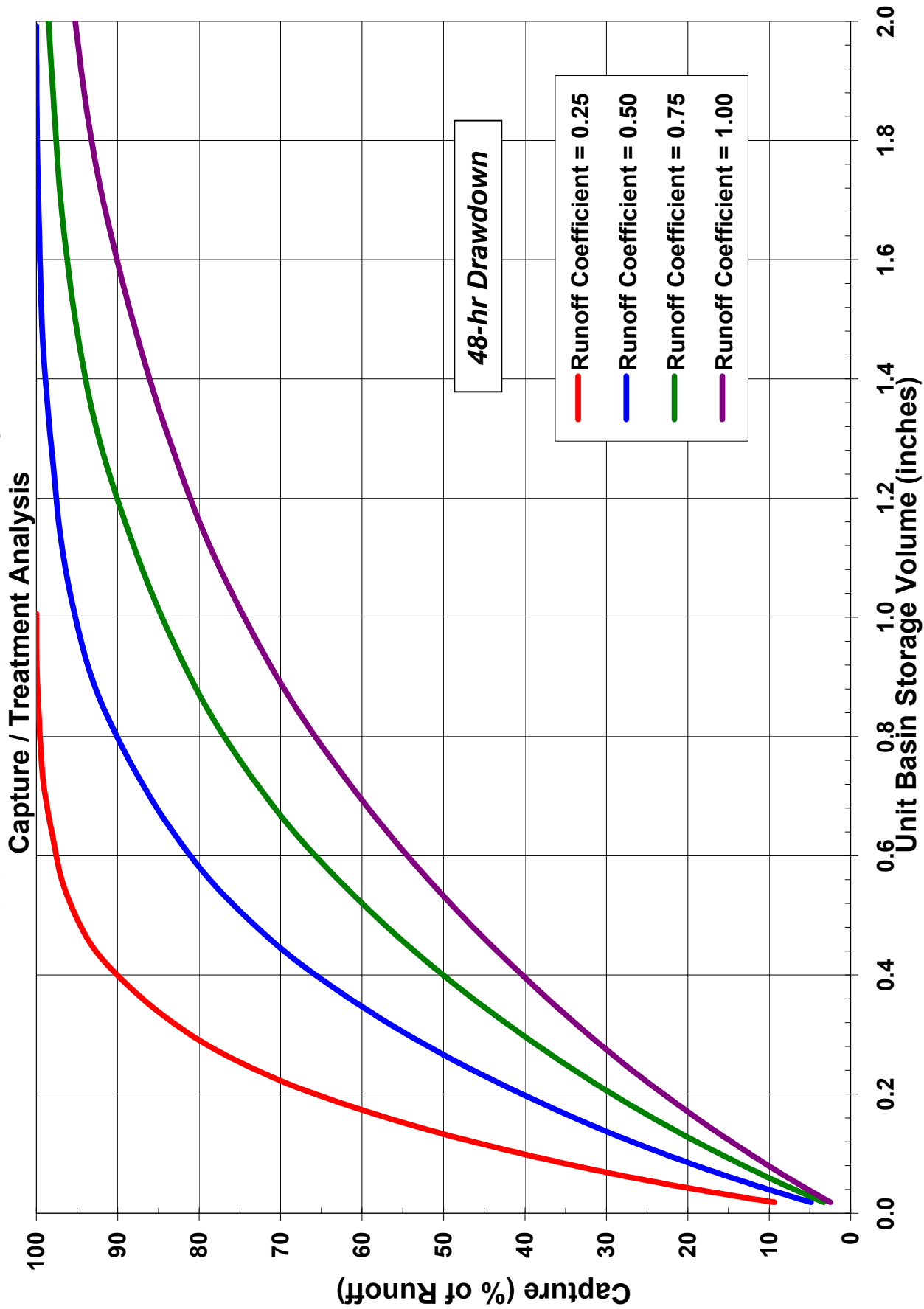

# Oxnard Equipment Yard (168) - Ventura County, California

## Capture / Treatment Analysis

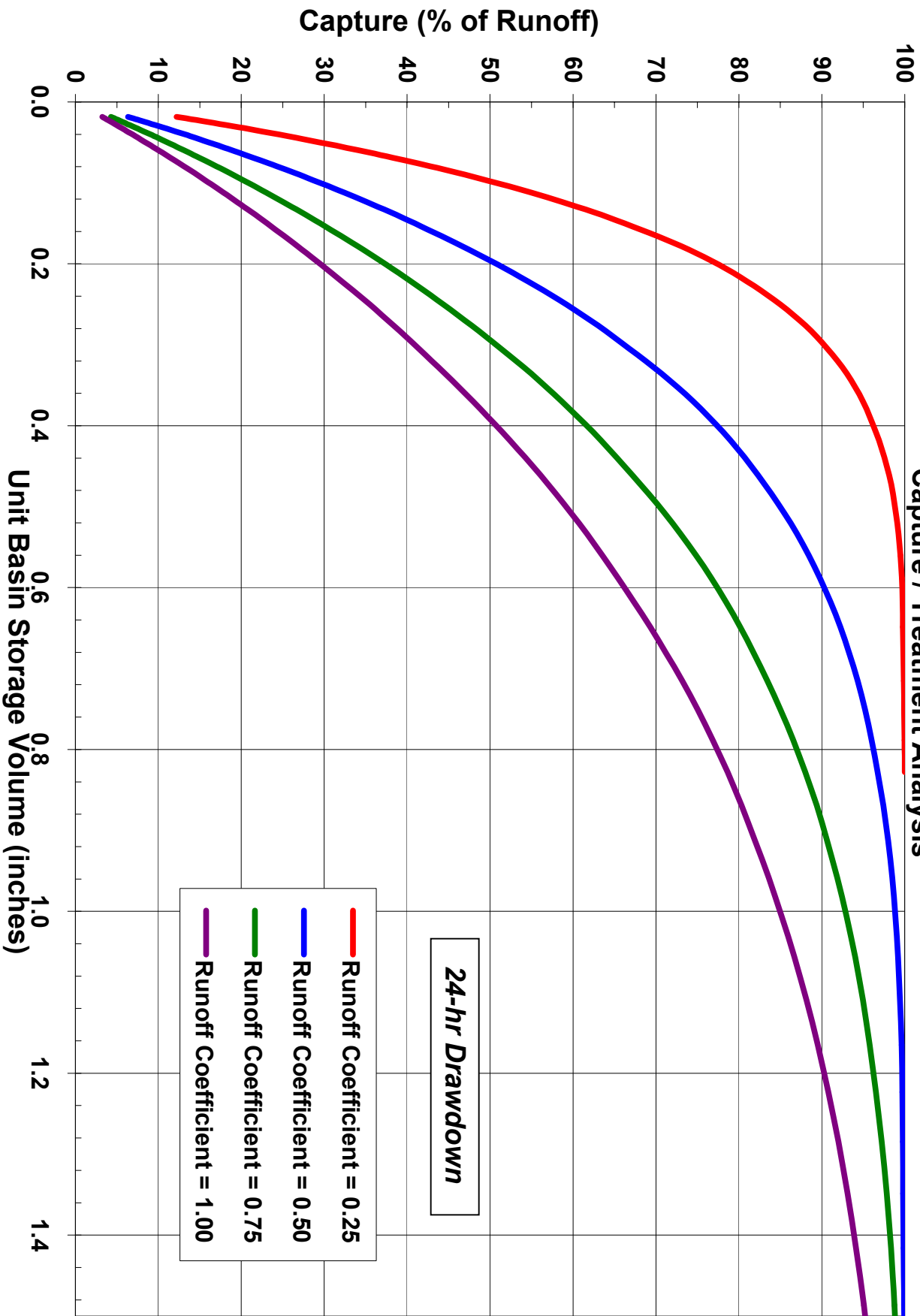

24-hr Drawdown

- Runoff Coefficient = 0.25
- Runoff Coefficient = 0.50
- Runoff Coefficient = 0.75
- Runoff Coefficient = 1.00



# Oxnard Equipment Yard (168) - Ventura County, California Cumulative Frequency Hourly Rainfall Intensity

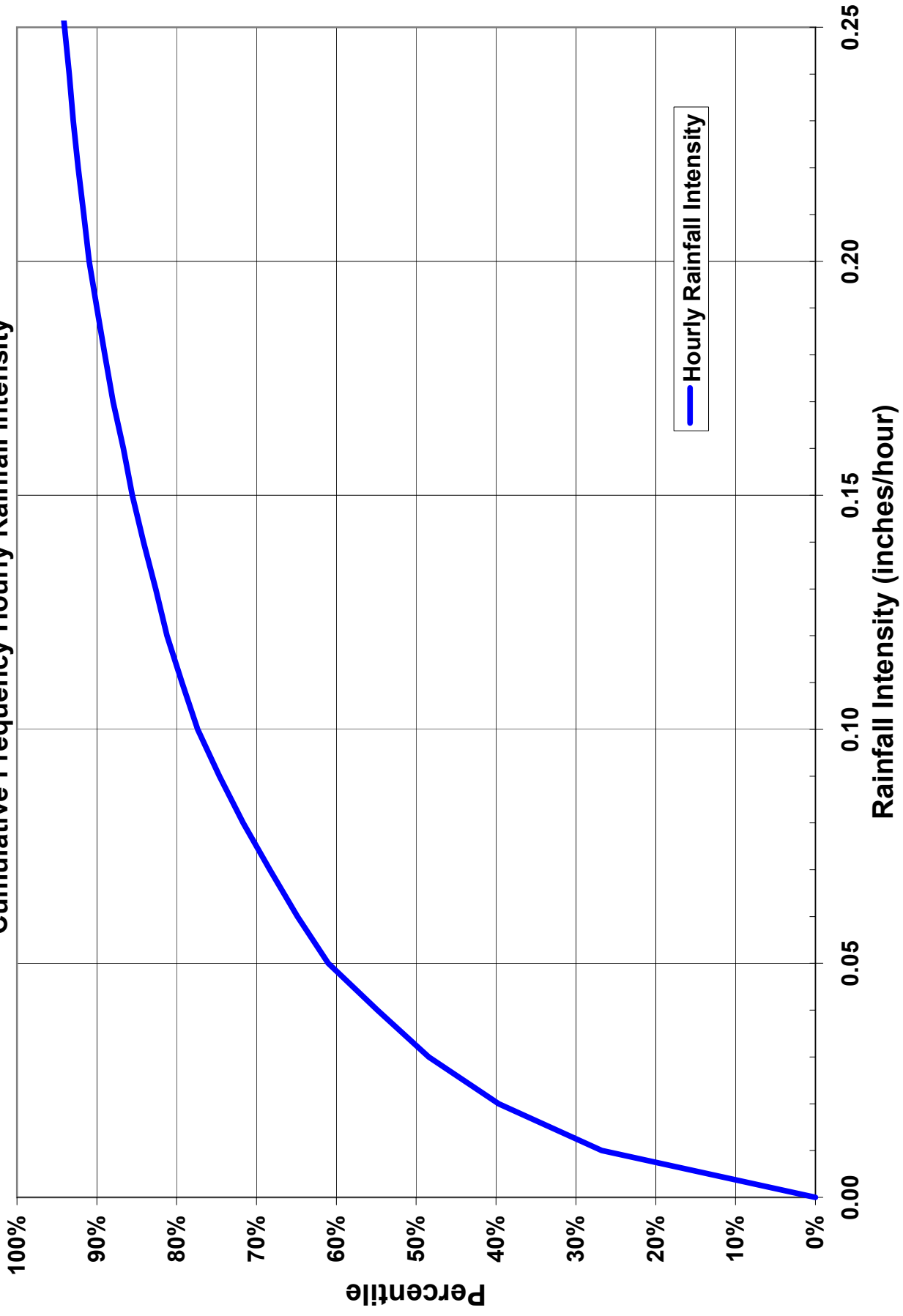

# Los Angeles WSO Airport (5114) - Los Angeles County, California

## Capture / Treatment Analysis

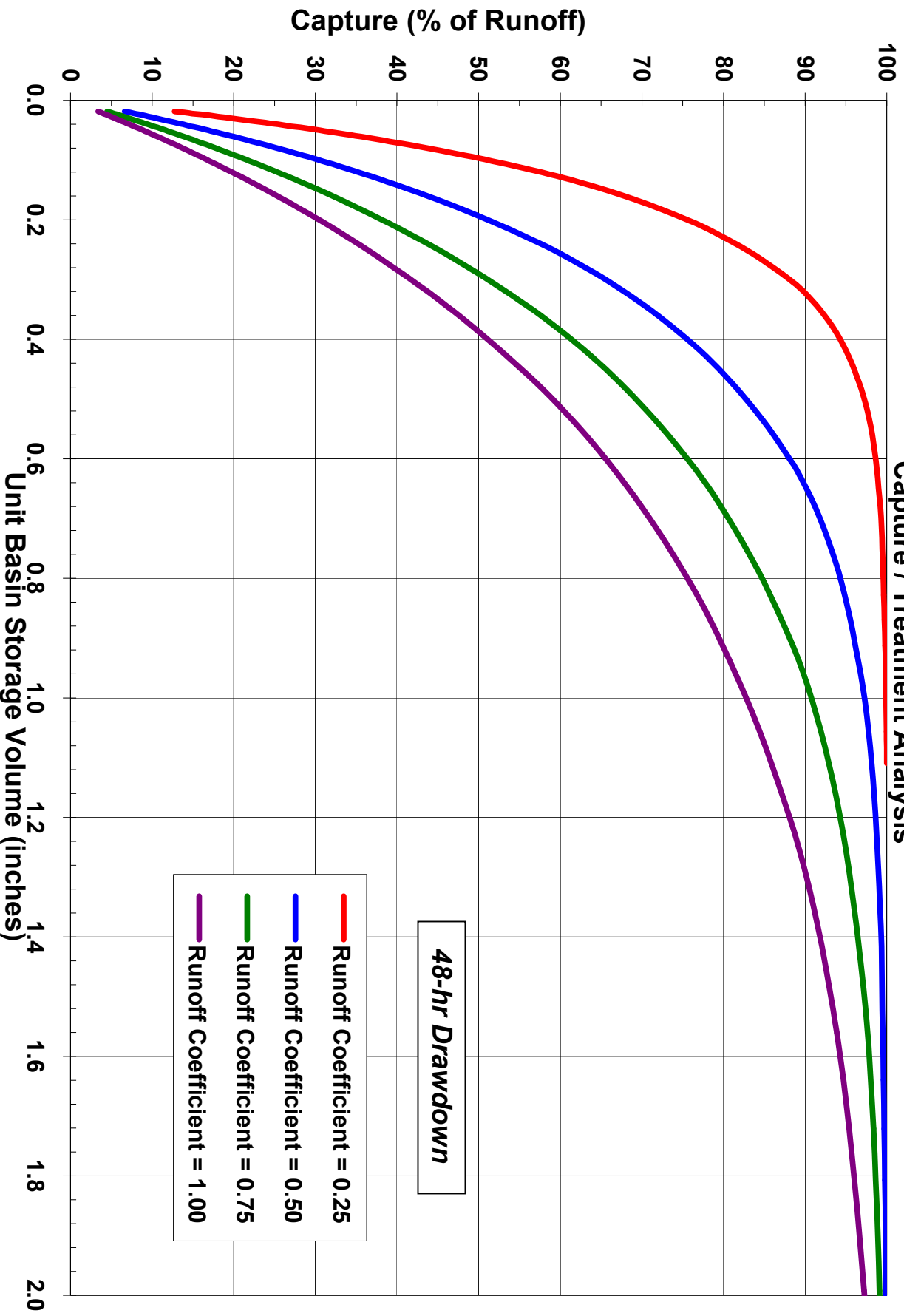

48-hr Drawdown

- Runoff Coefficient = 0.25
- Runoff Coefficient = 0.50
- Runoff Coefficient = 0.75
- Runoff Coefficient = 1.00

# Los Angeles WSO Airport (5114) - Los Angeles County, California

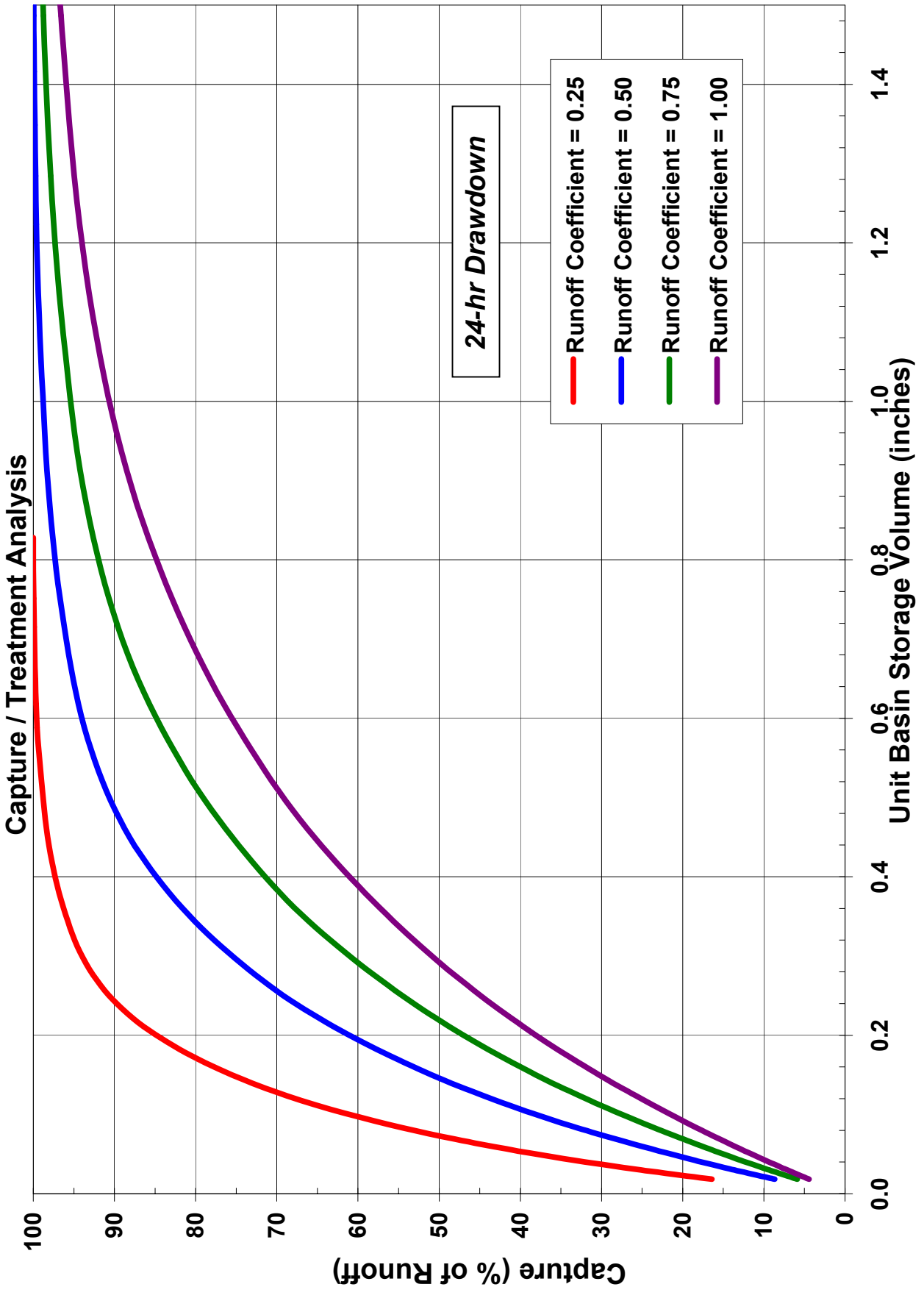

Los Angeles WSO Airport (5114) - Los Angeles County, California  
Cumulative Frequency Hourly Rainfall Intensity

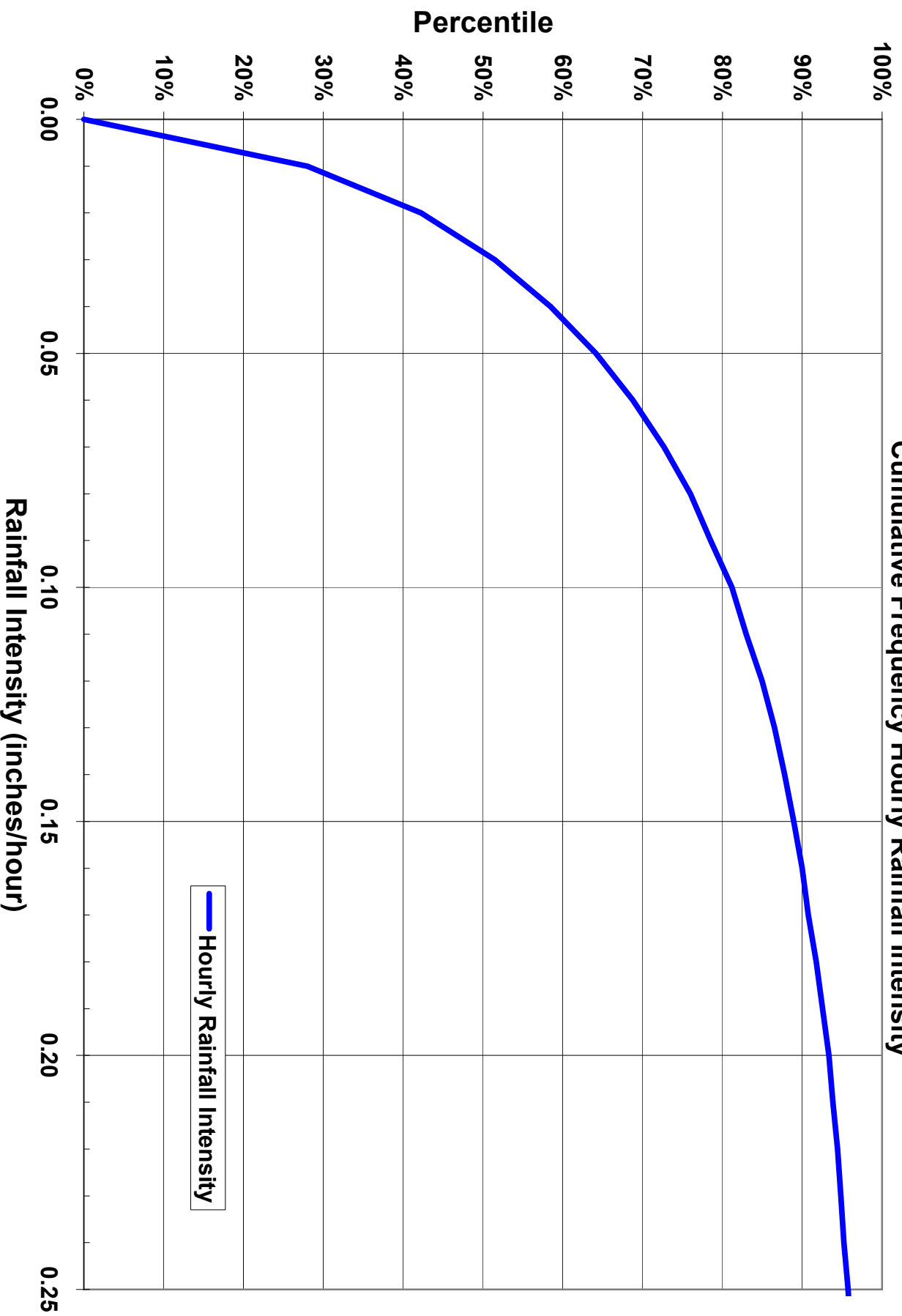

# Laguna Beach (4650) - Orange County, California

## Capture / Treatment Analysis

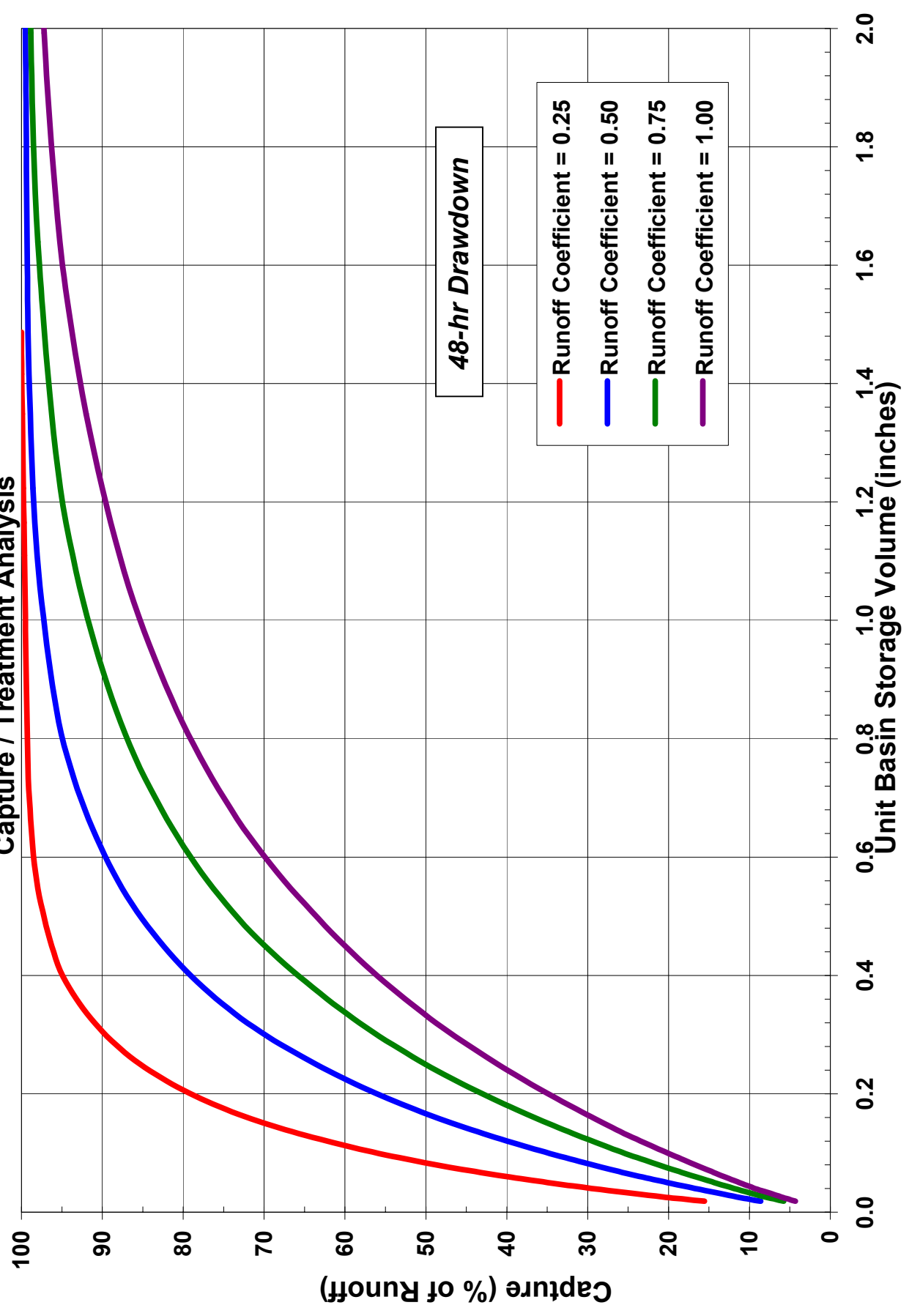

48-hr Drawdown

- Runoff Coefficient = 0.25
- Runoff Coefficient = 0.50
- Runoff Coefficient = 0.75
- Runoff Coefficient = 1.00

# Laguna Beach (4650) - Orange County, California Capture / Treatment Analysis

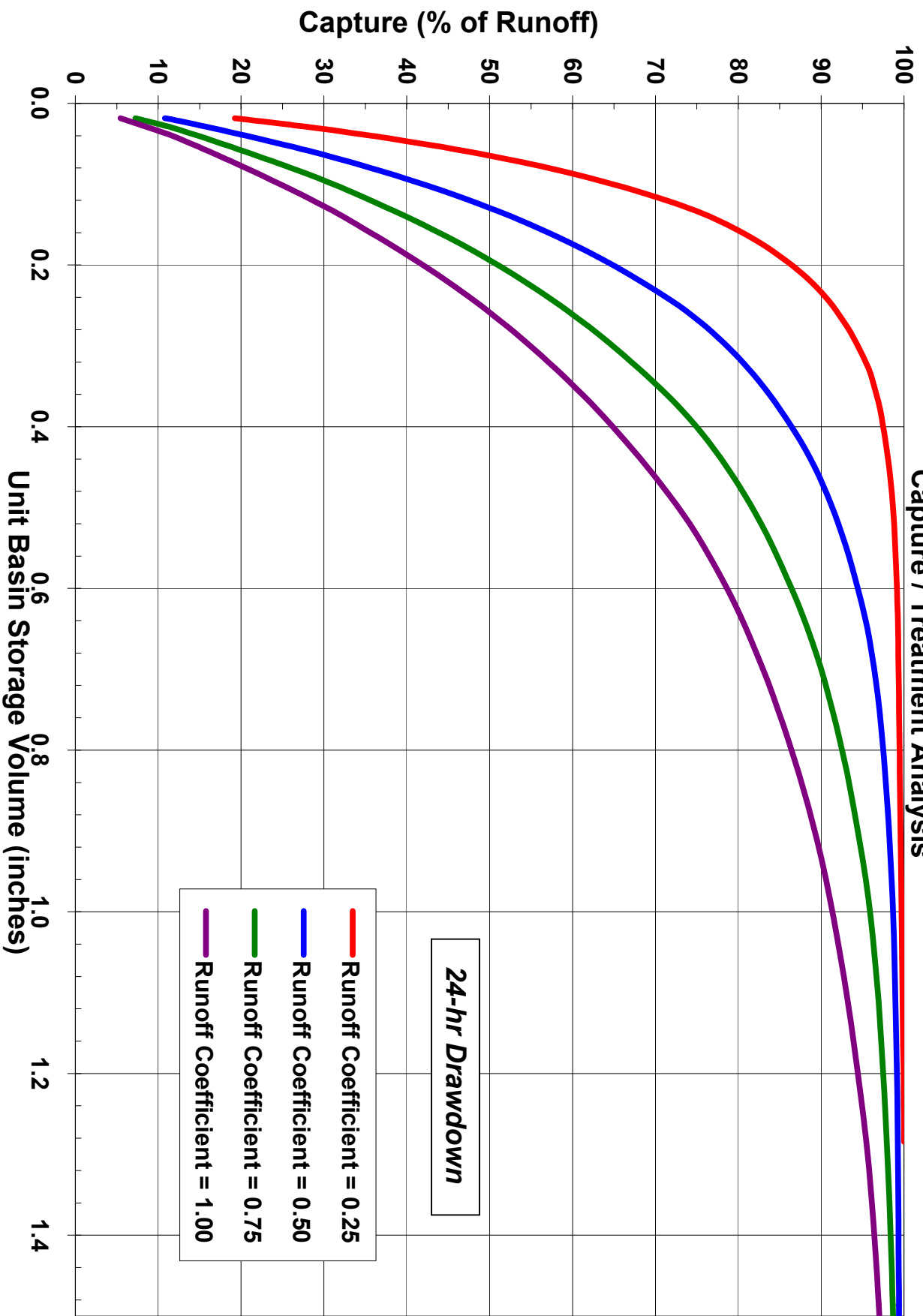

# Laguna Beach (4650) - Orange County, California Cumulative Frequency Hourly Rainfall Intensity

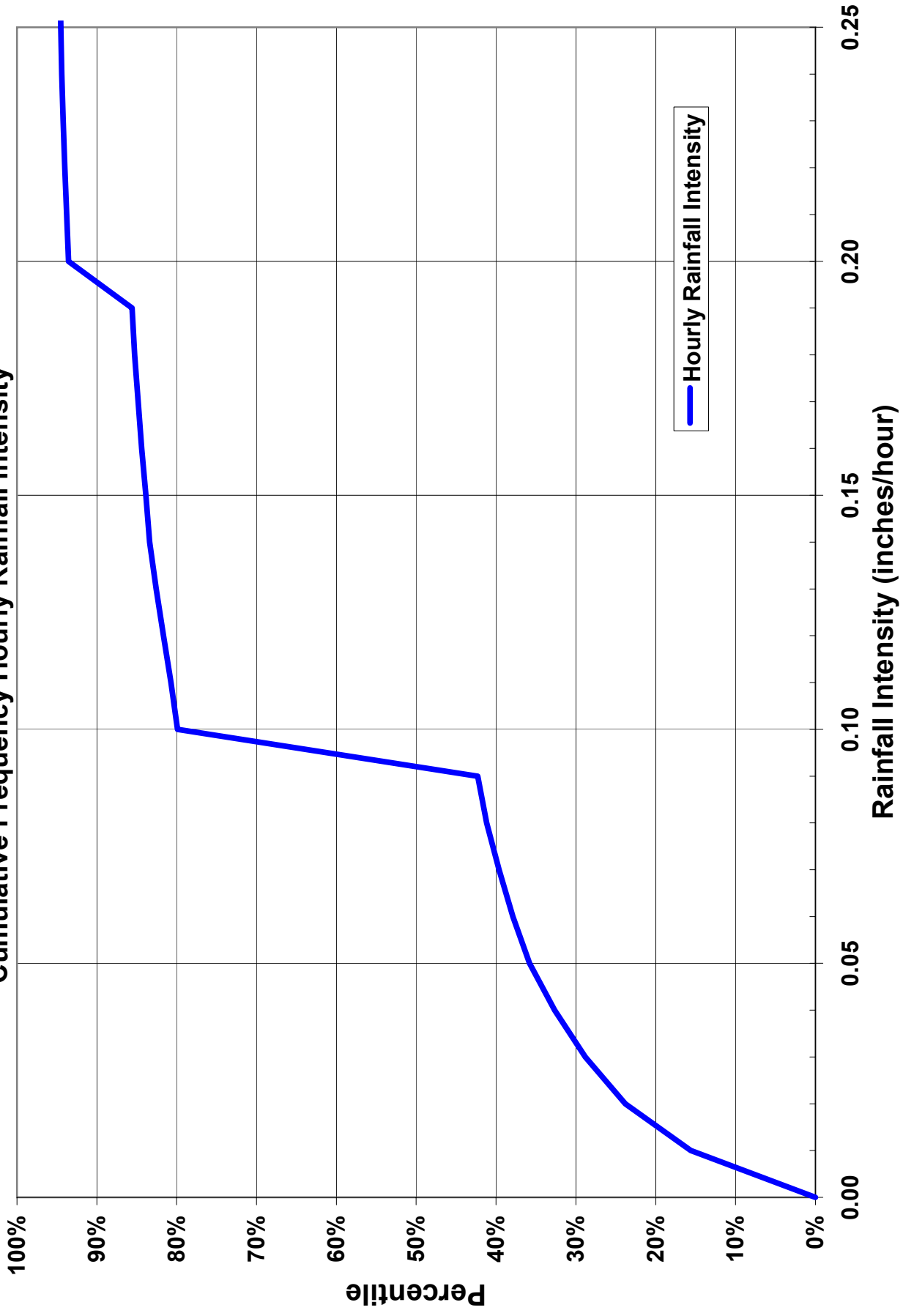

Silverado Ranger Station (8243) - Orange County, California

Capture / Treatment Analysis

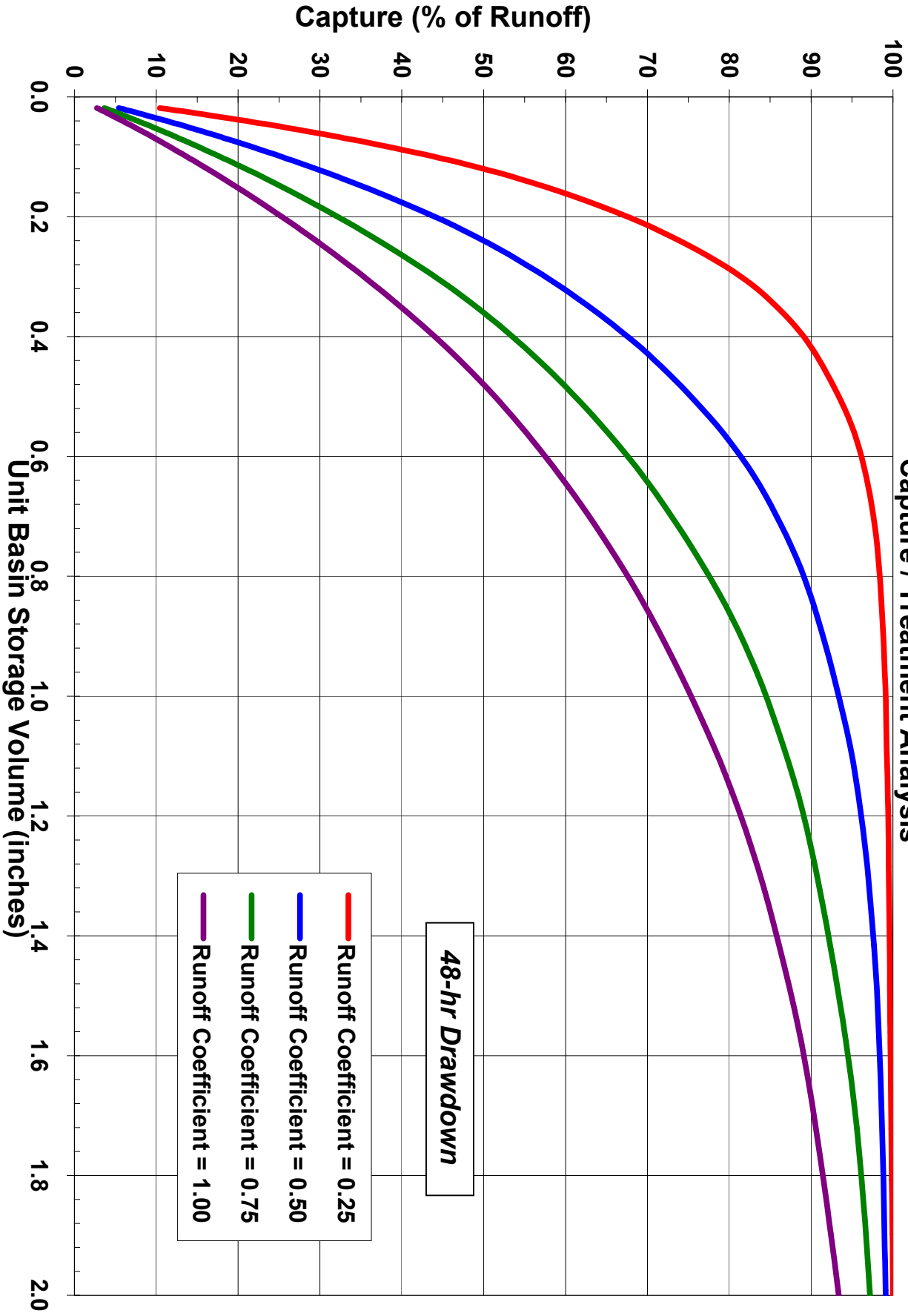

48-hr Drawdown

- Runoff Coefficient = 0.25
- Runoff Coefficient = 0.50
- Runoff Coefficient = 0.75
- Runoff Coefficient = 1.00



# Silverado Ranger Station (8243) - Orange County, California

## Capture / Treatment Analysis

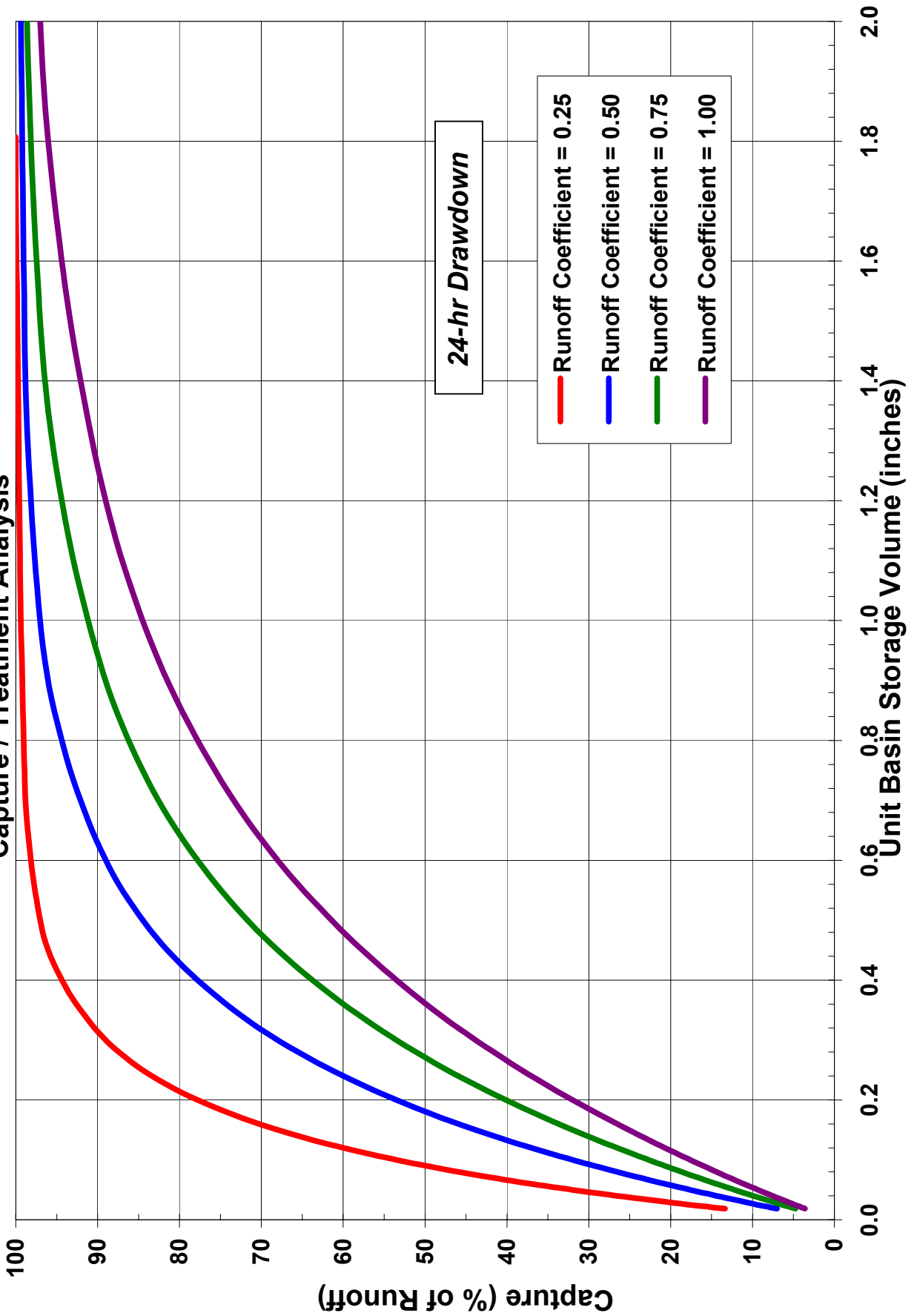

**Silverado Ranger Station (8243) - Orange County, California**  
**Cumulative Frequency Hourly Rainfall Intensity**

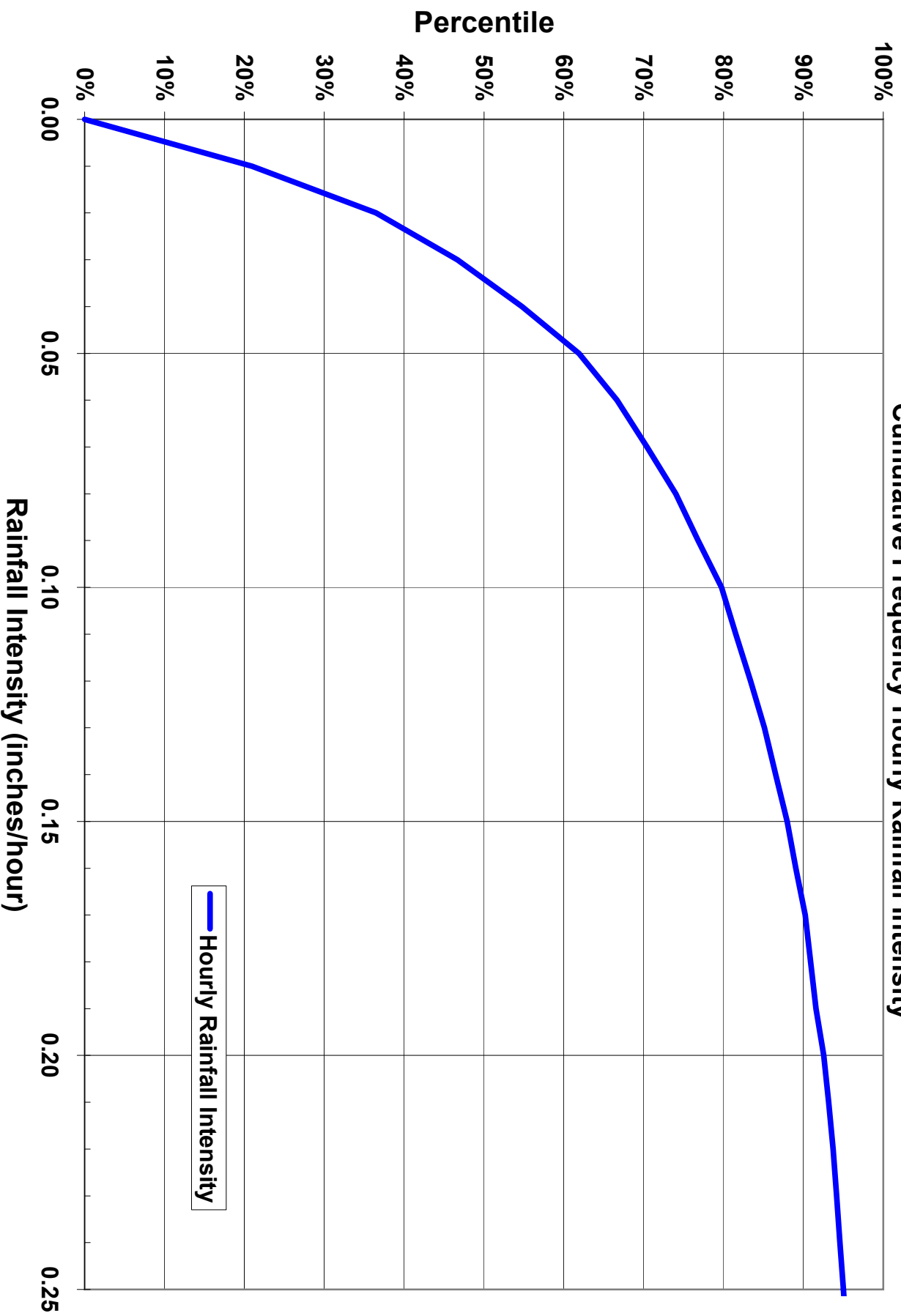

Riverside Citrus Experiment Station (7473) - Riverside County, California  
Capture / Treatment Analysis

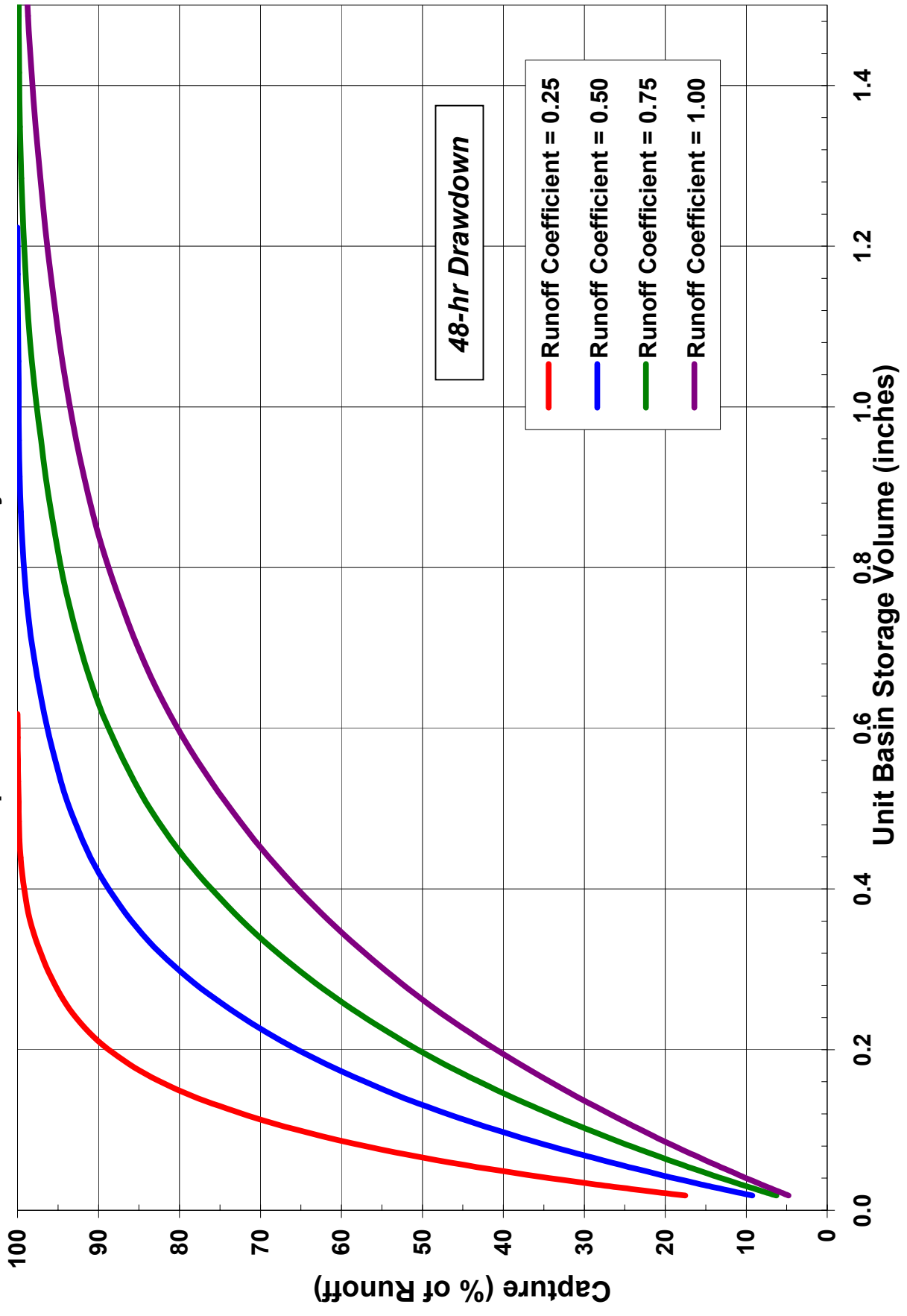

Riverside Citrus Experiment Station (7473) - Riverside County, California  
Capture / Treatment Analysis

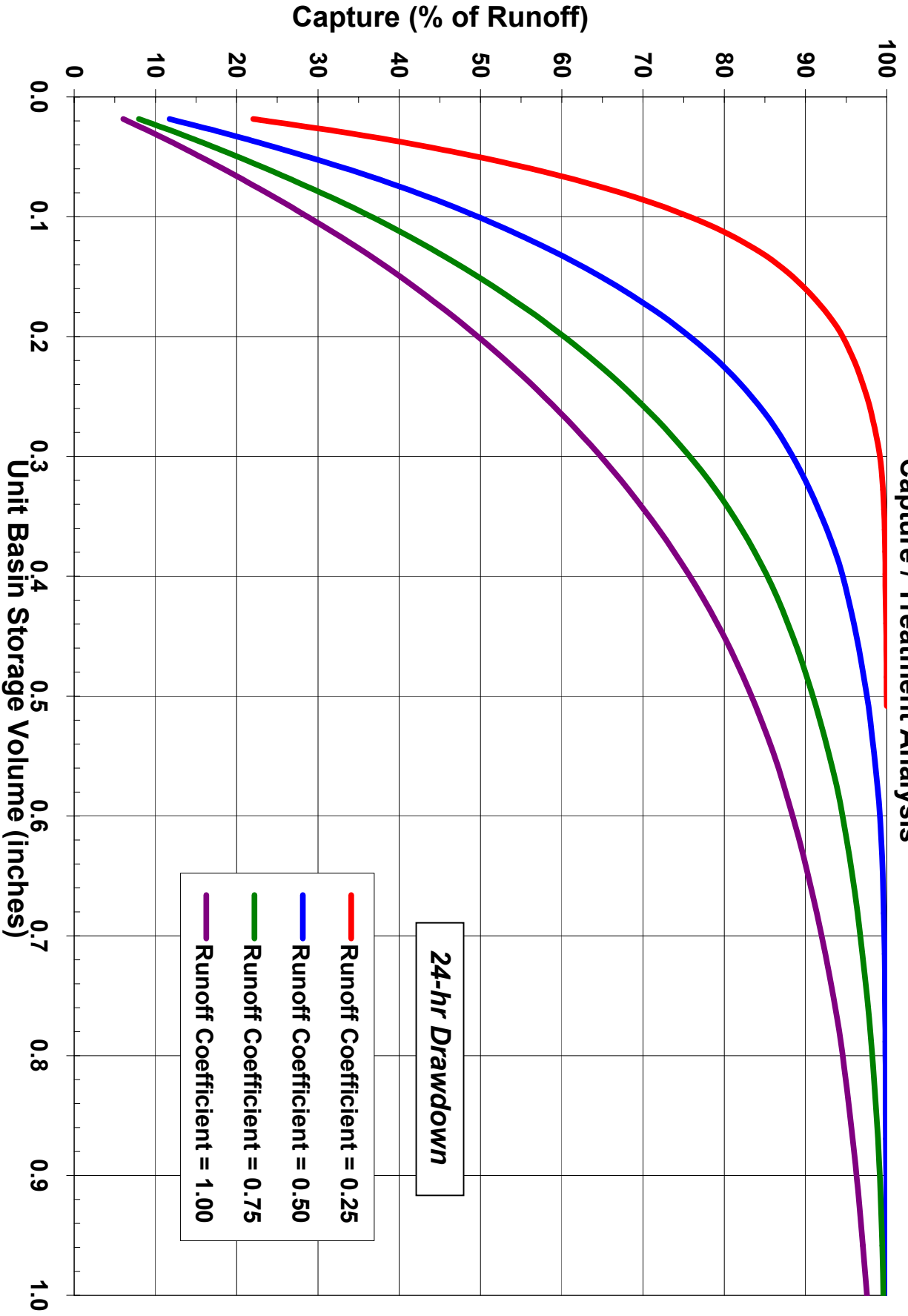

**Riverside Citrus Experiment Station (7473) - Riverside County, California**  
**Cumulative Frequency Hourly Rainfall Intensity**

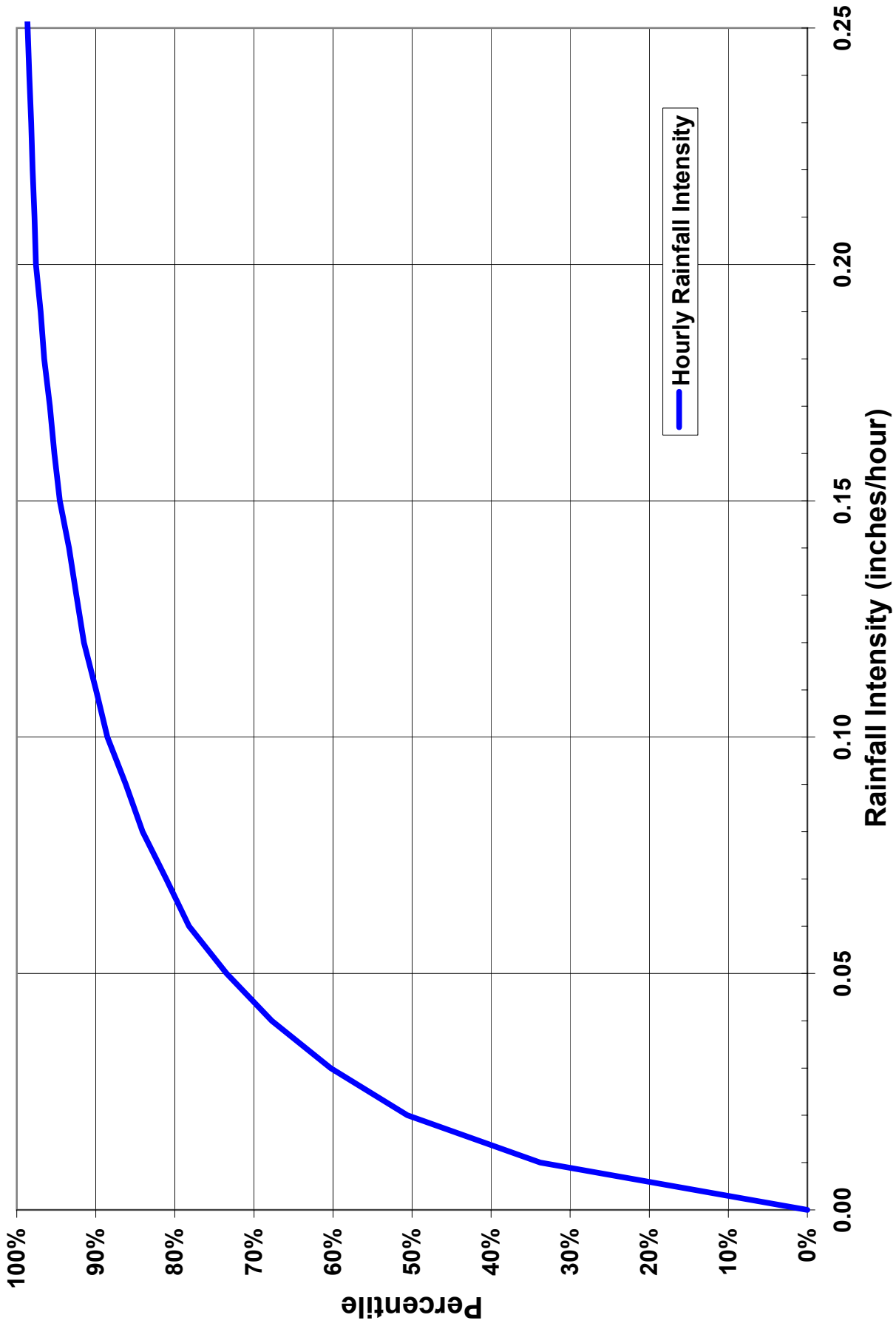

Victorville Pump Plant (9325) - San Bernardino County, California

Capture / Treatment Analysis

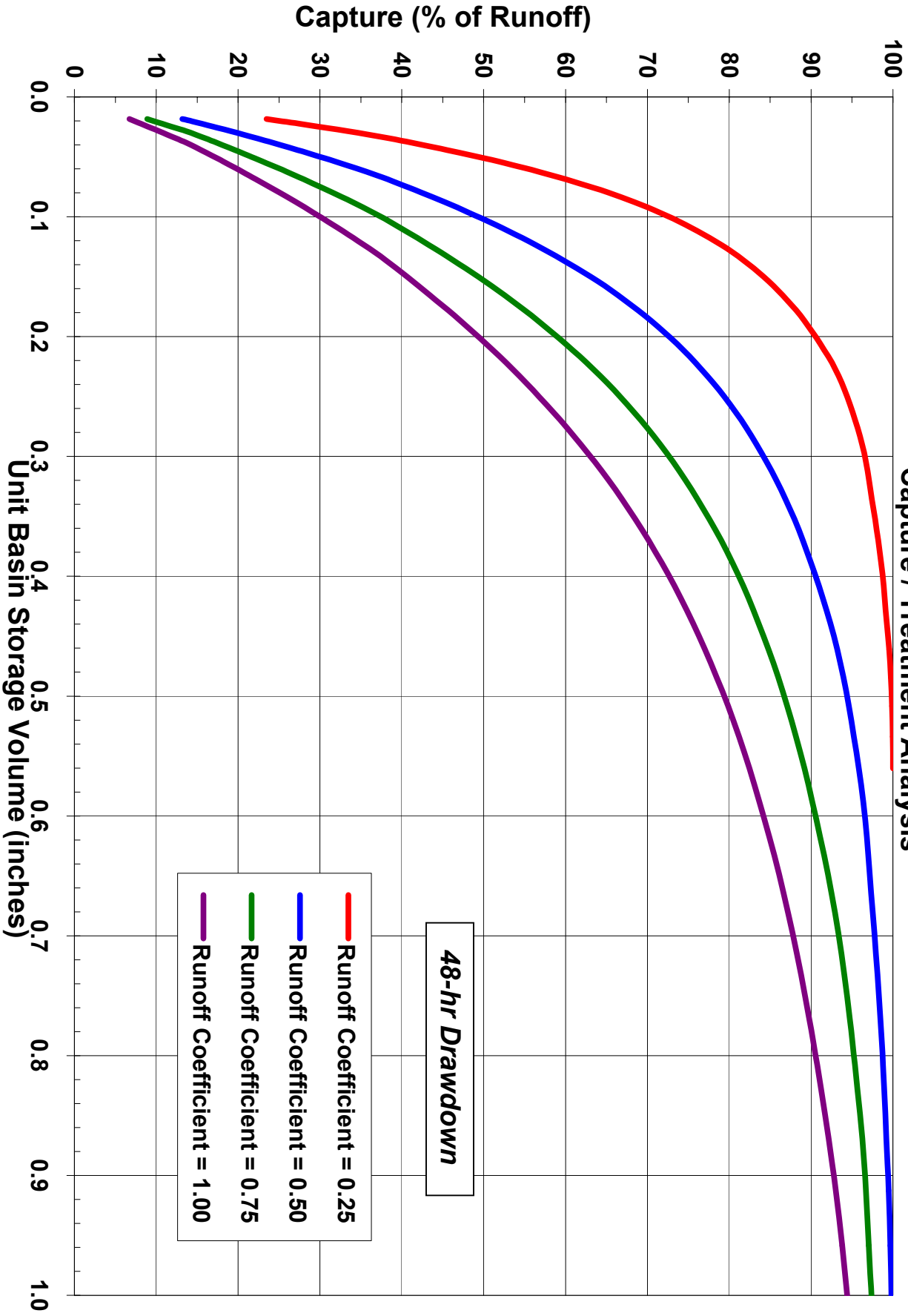

# Victorville Pump Plant (9325) - San Bernardino County, California

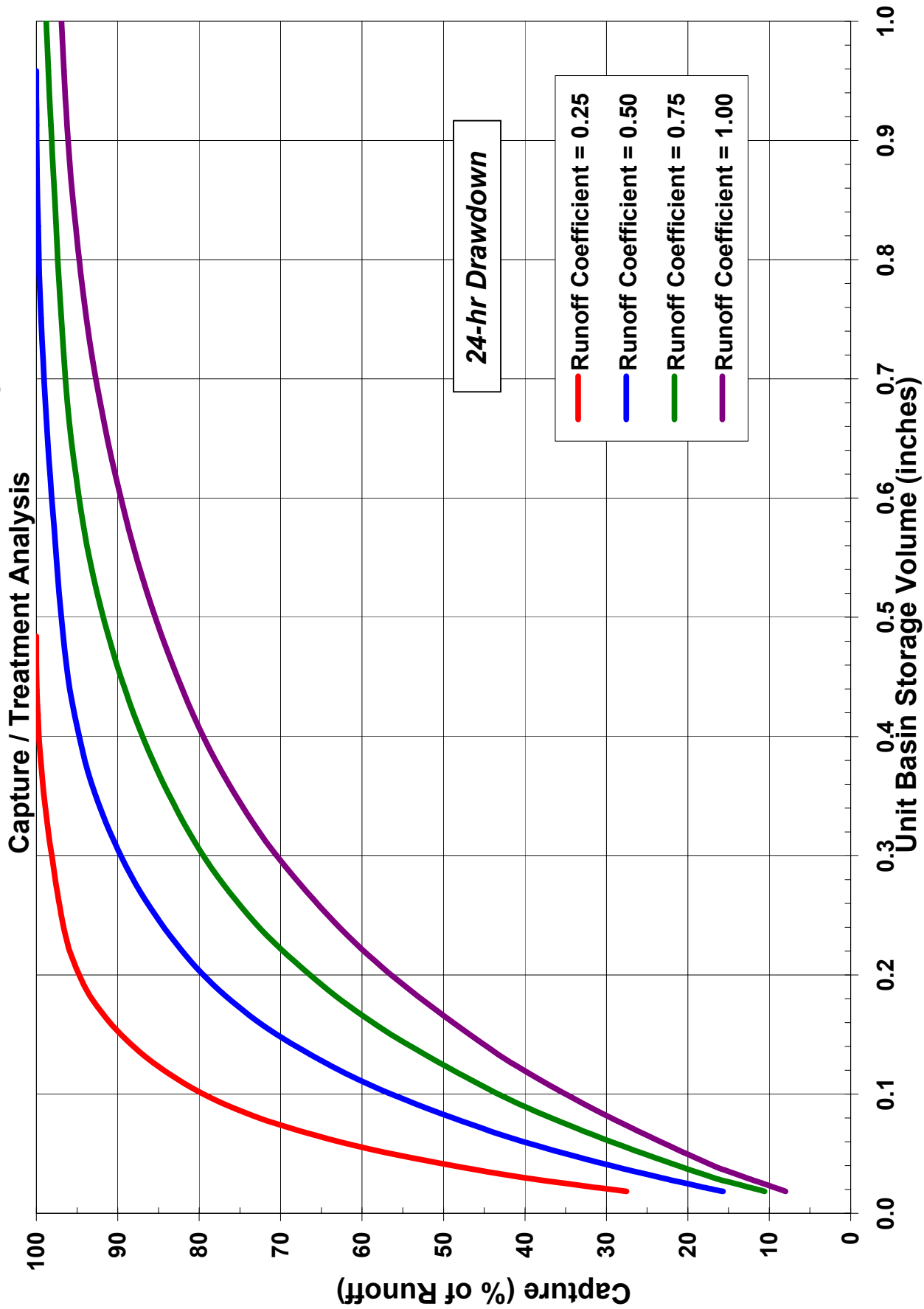

Victorville Pump Plant (9325) - San Bernardino County, California  
Cumulative Frequency Hourly Rainfall Intensity

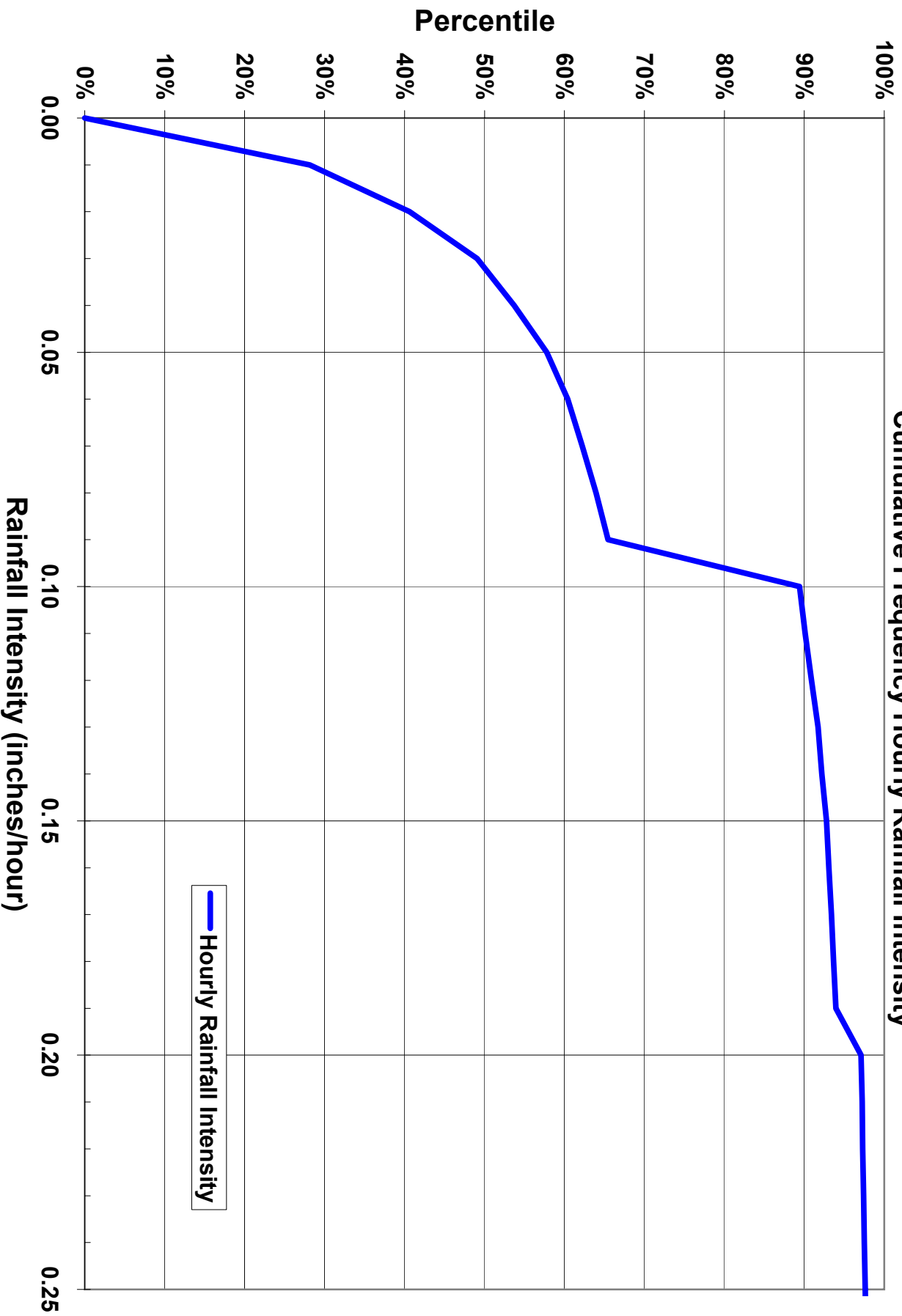



# San Diego WSO Airport (7740) - San Diego County, California

## Capture / Treatment Analysis

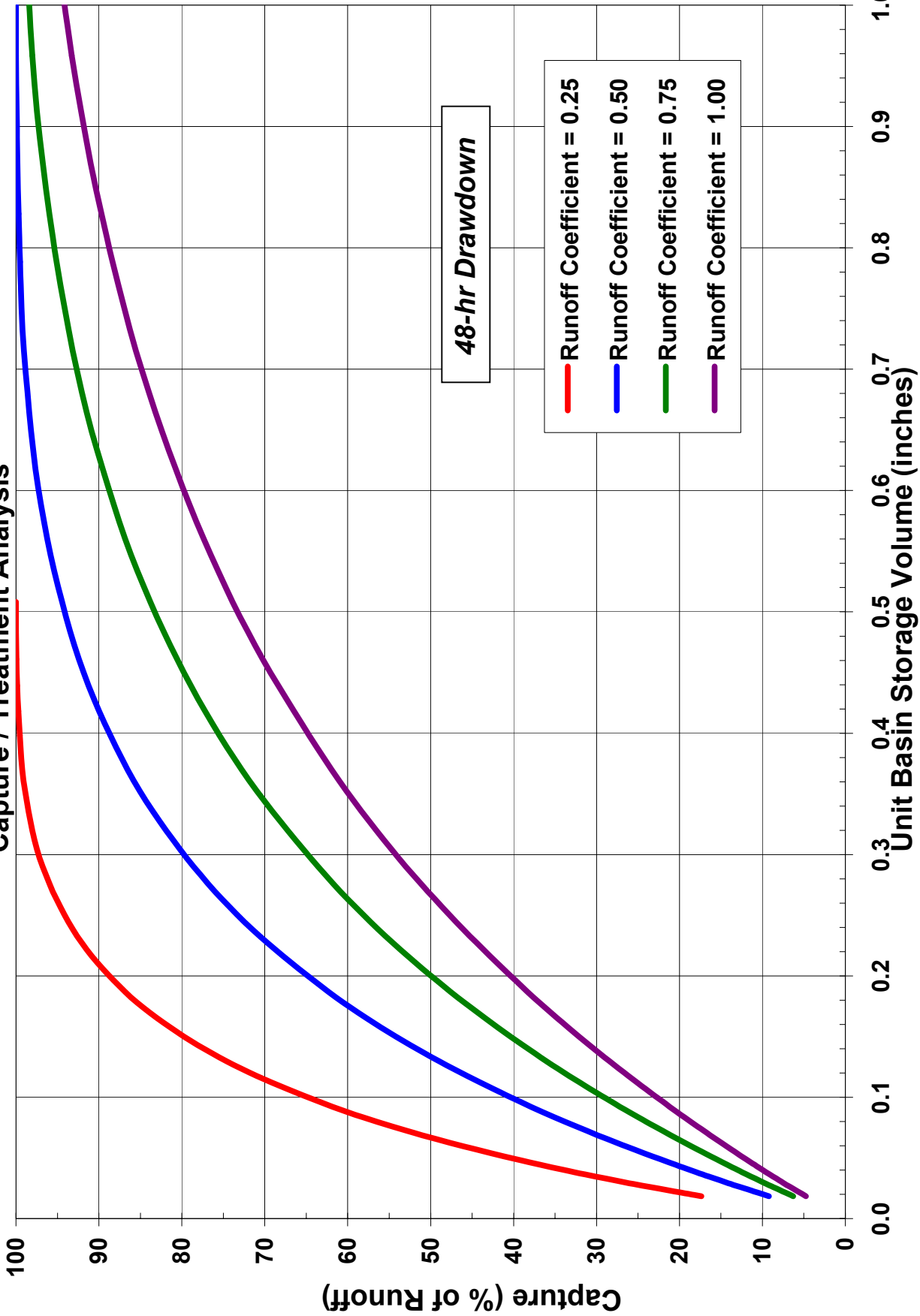

# San Diego WSO Airport (7740) - San Diego County, California

## Capture / Treatment Analysis

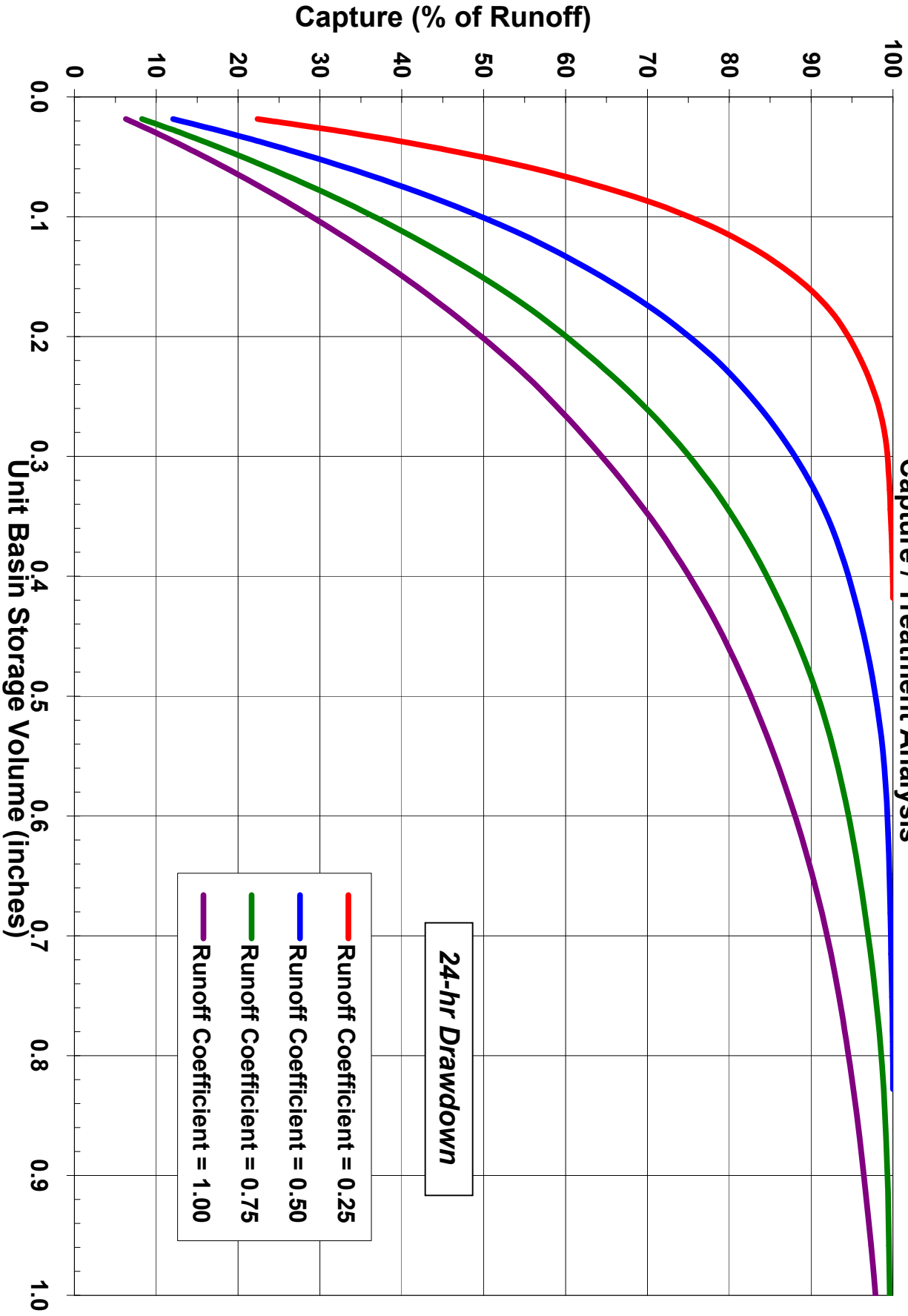

24-hr Drawdown

- Runoff Coefficient = 0.25
- Runoff Coefficient = 0.50
- Runoff Coefficient = 0.75
- Runoff Coefficient = 1.00

San Diego WSO Airport (7740) - San Diego County, California  
Cumulative Frequency Hourly Rainfall Intensity

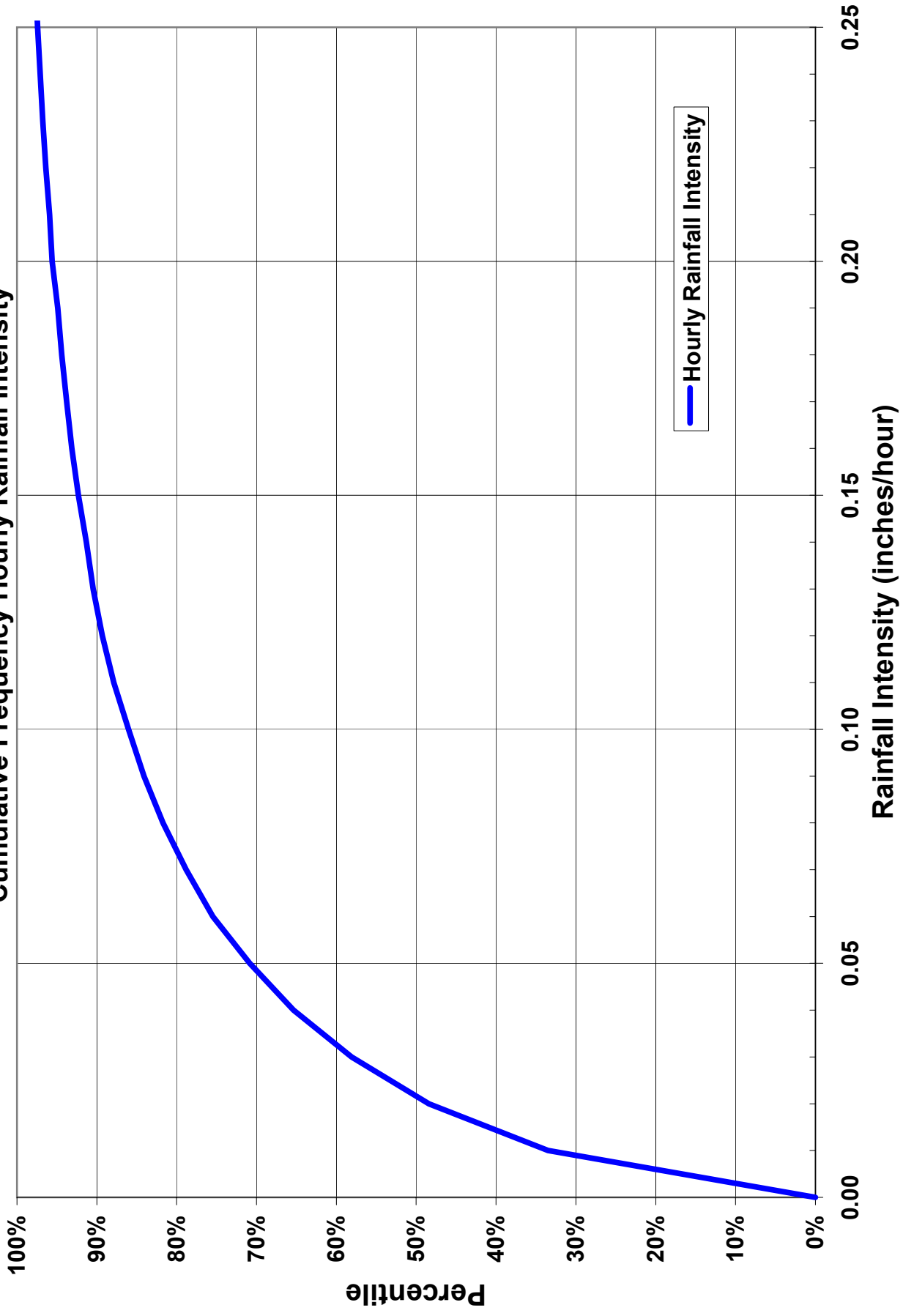

# Santa Susana Station (193) - Ventura County, California

## Capture / Treatment Analysis

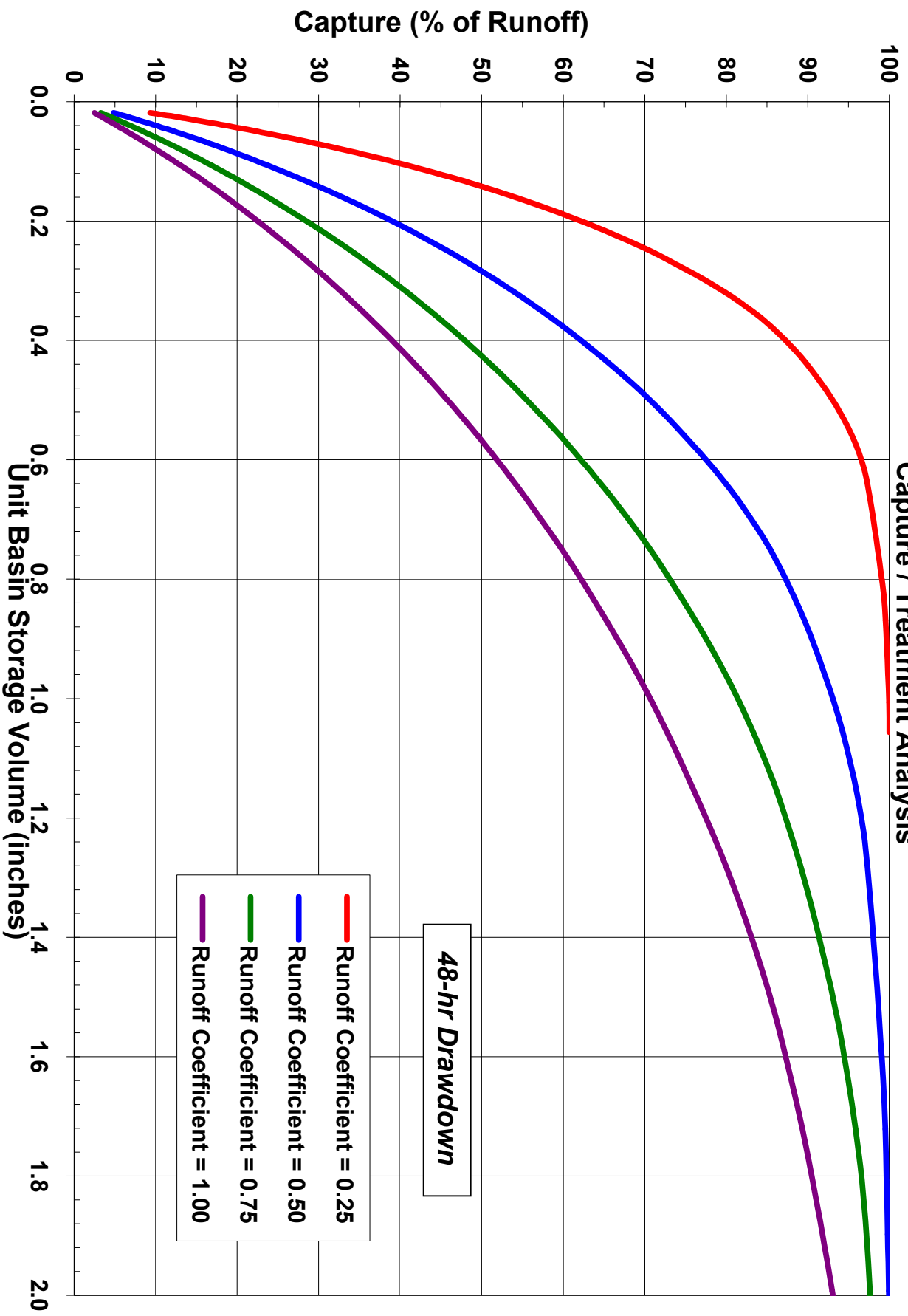

# Santa Susana Station (193) - Ventura County, California

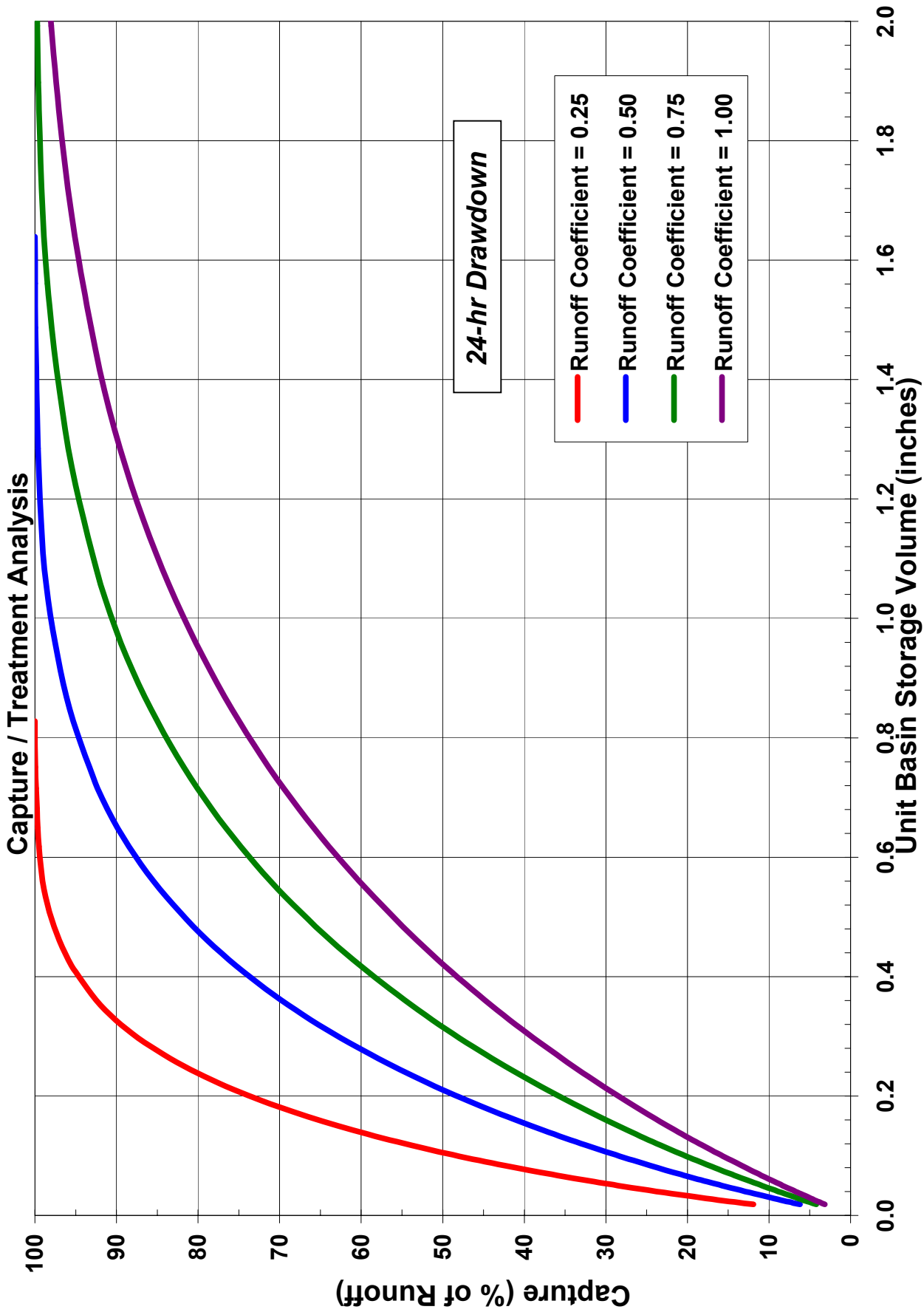

**Santa Susana Station (193) - Ventura County, California**  
**Cumulative Frequency Hourly Rainfall Intensity**

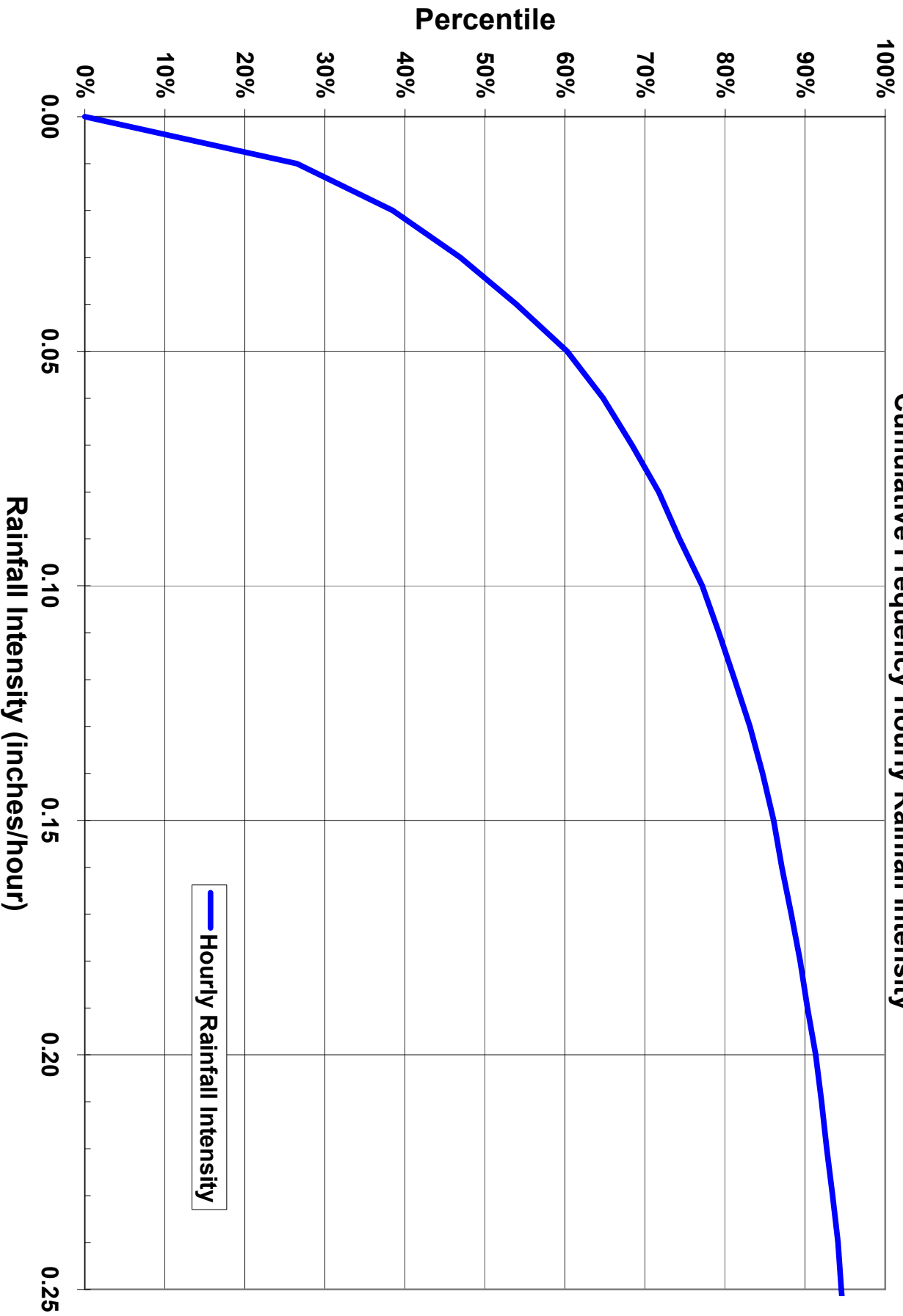

# Palm Springs Thermal Airport (48892) - Riverside County, California

## Capture / Treatment Analysis

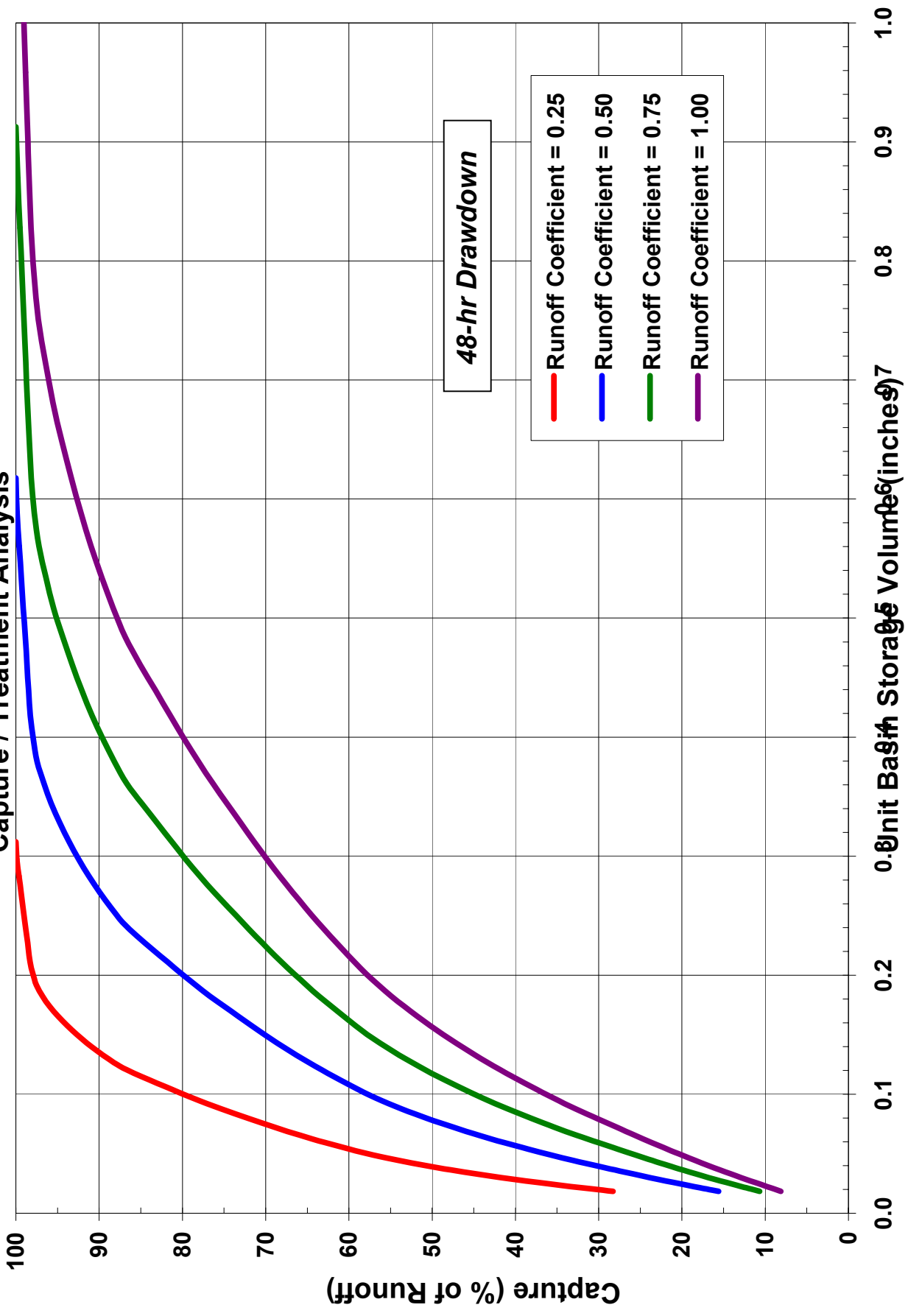

Palm Springs Thermal Airport (48892) - Riverside County, California

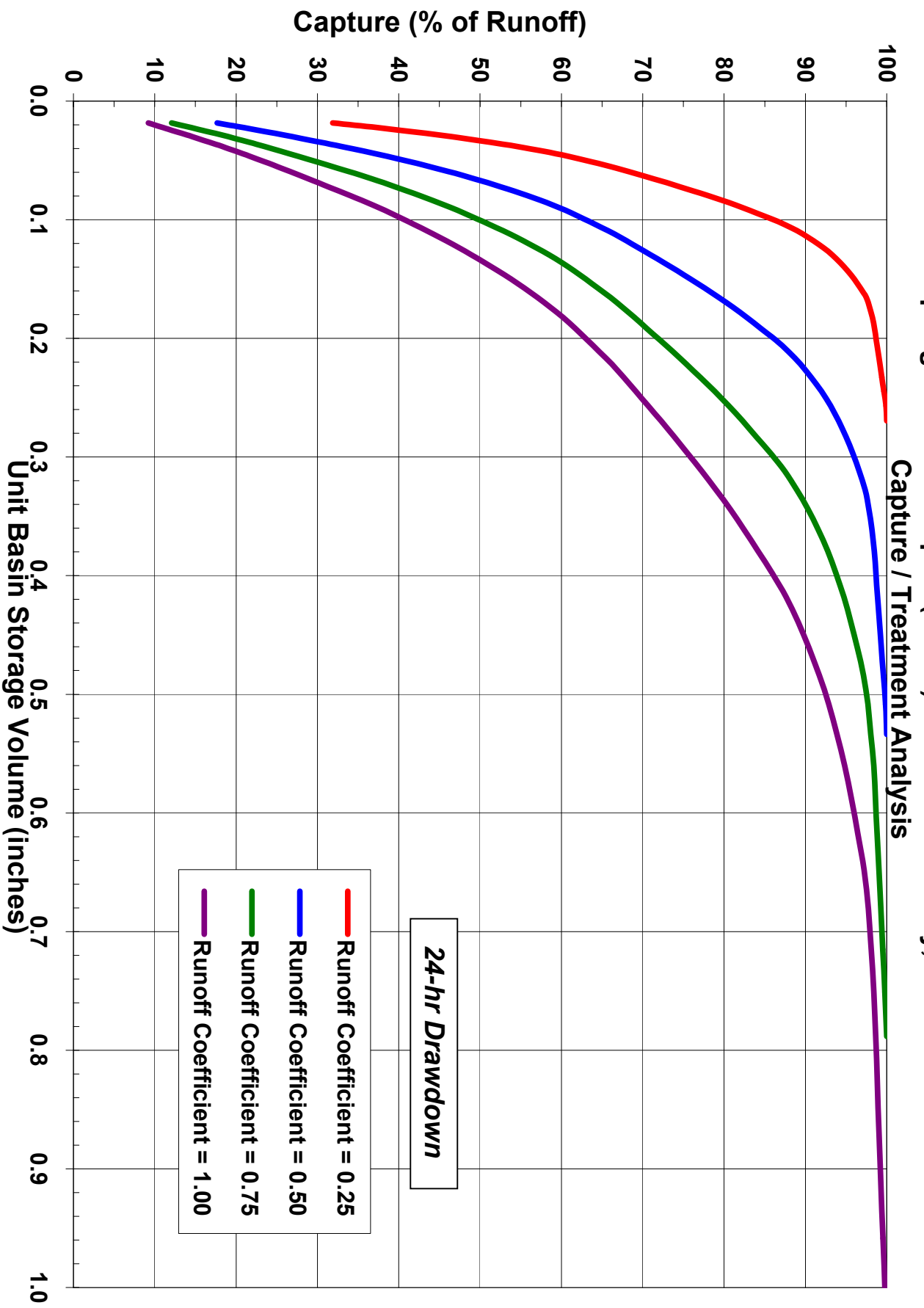



**Palm Springs Thermal Airport (48892) - Riverside County, California**  
**Cumulative Frequency Hourly Rainfall Intensity**

